

KAWAI

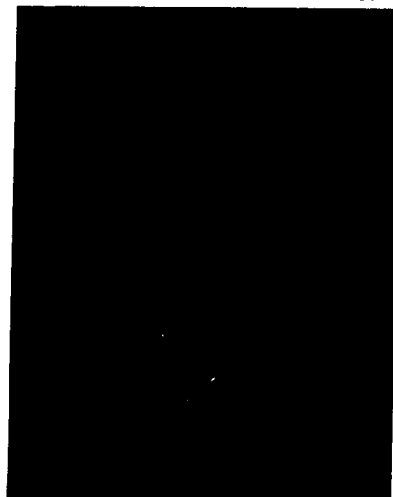

PERSONAL KEYBOARD **FS630**

Owner's Manual



Thank you for your purchase of the KAWAI FS630 Personal Keyboard.

Congratulations on your purchase of one of the most exciting keyboards available today! KAWAI's FS630 is superbly engineered musical instrument designed to bring you fun and enjoyment—no matter what your level of musical experience may be. You'll have fun as this manual helps you explore the powerful and exciting features of the FS630—particularly our exclusive ONE FINGER AD-LIB™. So, enjoy! And again, thank you for choosing KAWAI!

■ Table of Contents:

■ Before Using the FS630	1
■ Overall Diagram and Explanation	2
■ Getting Started on your FS630 Selecting Sounds	4
■ Adding Effects and Using Hand Percussion.....	5
■ Getting Started with Rhythms.....	6
■ Changing Rhythm Tempo.....	6
■ Using Auto-Accompaniment	7
■ Using ONE FINGER AD-LIB for an ad-lib performance	8
■ Using the SYSTEM Functions.....	11
■ Chord Table.....	12
■ Specifications	

■ WARNING:

This equipment generates, uses, and can radiate radio frequency energy. If not installed and used in accordance with the instruction manual, it can cause interference to radio communications. The rules with which it must comply afford reasonable protection against interference when used in most locations. However, there can be no guarantee that such interference will not occur in a particular installation. If this equipment is suspected of causing interference with other electronic devices, verification can be made by turning its power off and on. If this equipment does appear to be the source of the interference, you should try to correct the interference by one or more of the following measures:

- reorient the receiving antenna.
 - move the receiver away from the instrument.
 - plug the instrument into a different outlet so that it and the receiver are on different branch circuits.
 - consult the dealer or a qualified service personnel.
- This instrument complies with the limits for class B digital apparatus, pursuant to the Radio Interference Regulations, C.R.C., c. 1374.

Before Using the FS630

1. Cautions

- Do not subject the FS630 to severe shocks.
- Do not expose the FS630 to direct sunlight, or high temperatures such as inside your car on a warm day.
- Do not use the FS630 where there is excessive moisture or dust.
- Do not disassemble or attempt to modify the FS630.
- Should the FS630 become soiled, clean it using a soft, dry cloth. If this does not remove the stain, wet the cloth slightly before wiping. Never use alcohol or thinner to clean the FS630.
- Do not allow foreign matter to enter the gaps between the keys or around the buttons.

2. Connecting the power supply

The FS630 can use either your home AC power outlet or dry cell batteries as a power source.

■ To insert batteries:

1. Turn the unit over and remove the battery cover.
2. Insert the six Size C dry cell batteries included with your FS630. Be sure that they are aligned correctly.
3. Replace the battery cover.

Notes:

- As the batteries reach the end of their usable lifespan, the sound of the FS630 will become quieter and the sound quality will begin to change. The unit may also begin to function improperly. At that time you should replace all six of the batteries.
- Do not mix battery types, as this may cause problems such as battery fluid leakage.
- Remove the batteries when not using the FS630 for long periods of time.

■ To use an AC power outlet:

Connect a PS-121 (or PS-123) adaptor (available separately) to the adaptor terminal on the rear panel of the FS630. Then, connect the adaptor to a wall socket.

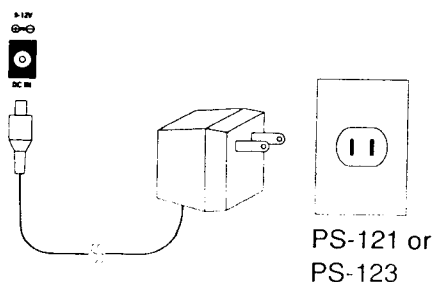
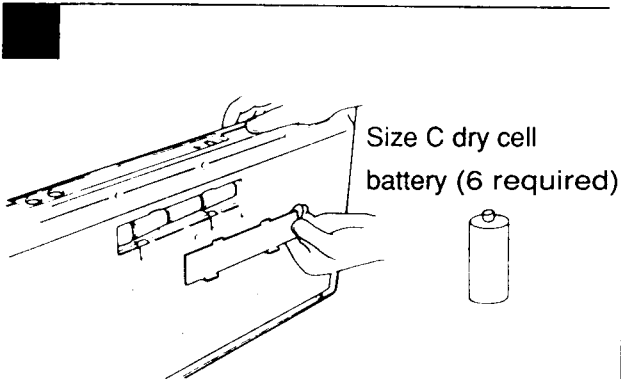

Overall Diagram and Explanation

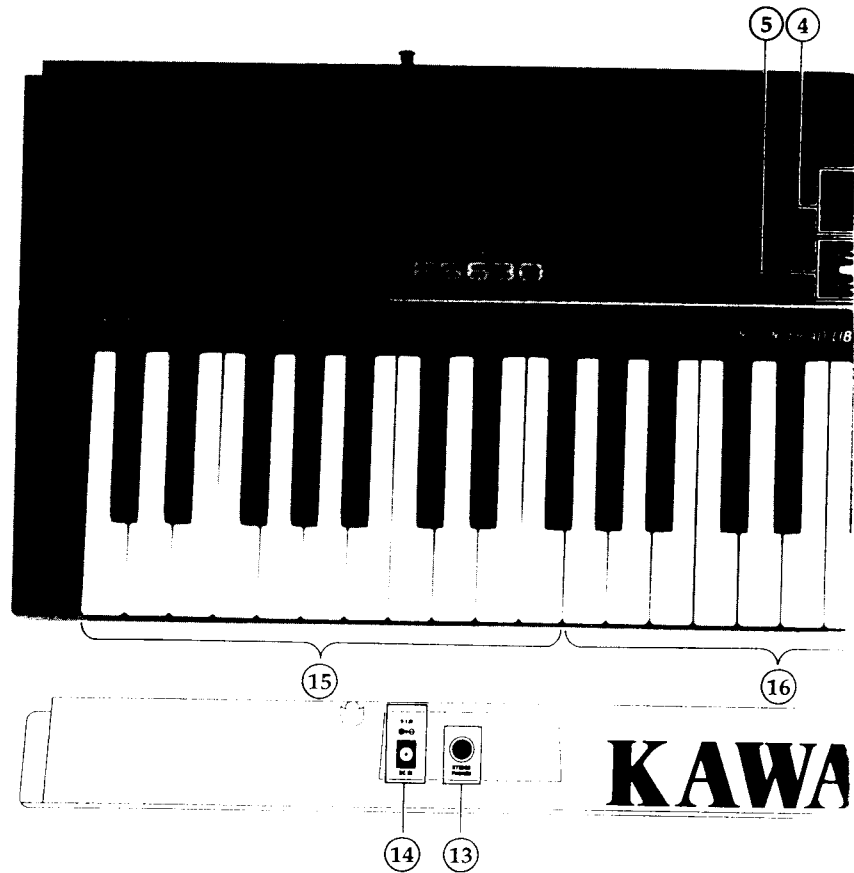

[Operation Panel]

- ① **POWER** switch
This switch turns the power on and off. When the power is turned on, the display window will light, showing the number \square 1.
- ② **Master Volume Control** buttons
The master volume buttons control overall volume of all notes played on the keyboard.
- ③ **DEMO** button
Pressing this button starts the built-in demo song contained in the FS630's memory. Press it again at any time to stop the demo song.
- ④ **Display**
The display window shows which sound or rhythm is currently selected. The window is also used to display a wide variety of other information which will be described later in this manual.
- ⑤ **SELECTOR** buttons
These buttons are used to increase or decrease the numbers in the display window by intervals of 1 or 10.

- ⑥ **SOUND** button
This button is used to select from among the one hundred sounds stored in the FS630.
- ⑦ **EFFECT** buttons
These buttons allow you to add variety to the FS630's one hundred sounds by adding effects such as Sustain and Stereo Chorus to them.
- ⑧ **AUTO** button
This button is used to select the playing mode for the nineteen keys on the left end of the keyboard (the Lower keyboard). There are two playing modes: Normal mode in which the Lower keyboard plays the same sound selected for the Upper keyboard; and AUTO mode which lets the Lower keyboard control FS630's Auto Accompaniment.
- ⑨ **RHYTHM** button
This button is used when selecting from among the twenty-five rhythms and accompaniment patterns stored in the FS630's memory.

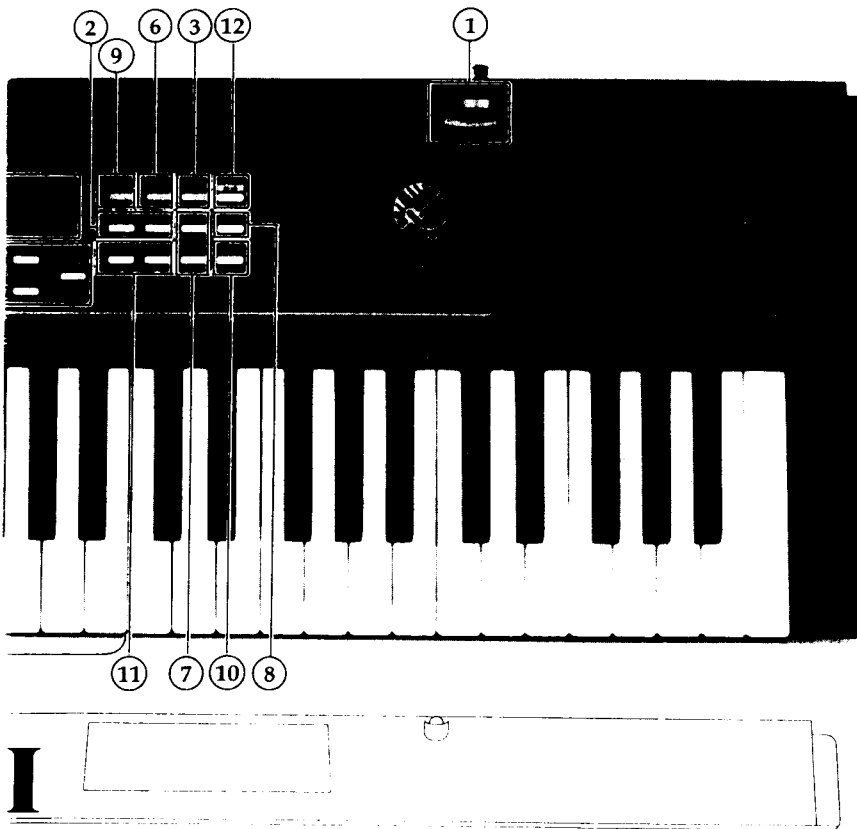

- ⑩ **START/STOP** button
This button starts and stops the rhythm or automatic accompaniment.
- ⑪ **TEMPO** buttons
These buttons control the tempo of the rhythm pattern or automatic accompaniment.
- ⑫ **ONE FINGER AD-LIB** button
This button activates KAWAI's exclusive ONE FINGER AD-LIB feature which allows you to sound like a "pro" with the touch of a finger.

[Rear Panel]

- ⑬ **Stereo Headphone** jack
When stereo headphones are connected to this jack, the sound from the speakers is cut off. This allows you to play the FS630 at night and at other times when you might be concerned about disturbing others.
- ⑭ **Power Adaptor** jack
This jack is used when connecting a power adaptor (model PS-121 or PS-123, available separately).

[Keys]

- ⑮ **Lower keys** (C1 ~ F#2)
Used to play chord forms and trigger Auto-Accompaniments when the FS630 is in AUTO mode.
- ⑯ **ONE FINGER AD-LIB** keys (G2 ~ B3)
Used to play ad-lib phrases when the ONE FINGER AD-LIB function is selected.

Note:

When the AUTO and ONE FINGER AD-LIB functions are turned off, all the keys of the FS630 operate in the NORMAL playing mode.

Getting Started on your FS630 Selecting Sounds

1

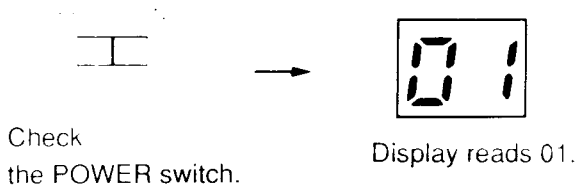

This section will show you how to select and play any of the sounds listed in the "100 SOUND LIBRARY" on the FS630's front panel.

1. First, check to be sure that the **POWER** switch is turned ON. The display should be lit, showing the number 01.

Try pressing one of the keys on the keyboard. You should hear the sound which is numbered 01 (STRINGS).

2

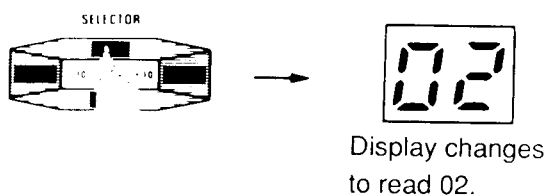

2. Next, look at the **SELECTOR** buttons and find the button marked +1. If you press it, the number shown in the display should change to 02.

When you press one of the keys on the keyboard, you will hear sound number 02 (SLOW STRINGS).

You can use the **SELECTOR** buttons to choose any of the FS630's one hundred sounds quickly and easily. The +1 button adds one to the number in the display, while the +10 button adds ten.

The -1 button subtracts one from the displayed number, and the -10 button subtracts ten. The number shown in the display is the number of the sound currently selected.

3

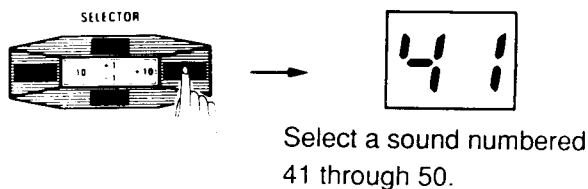

3. If you select one of the **SPLIT** sounds, which are numbered 41 through 50 in the "100 SOUND LIBRARY," you will find that the 19 keys on the left end of the keyboard (which we will refer to as the Lower keyboard) produce a different sound from the rest of the keys to their right. The FS630 is "split" into two sections with a separate sound assigned to each section.

Also, note that the numbers "wrap around," so that pressing the +1 button when the display reads 00 will change the display to read 01.

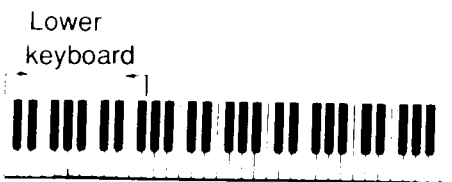

Adding Effects and Using Hand Percussion

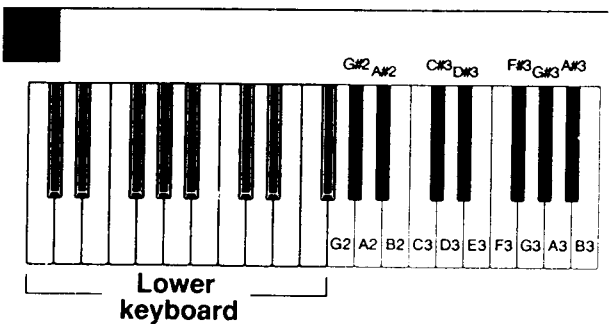
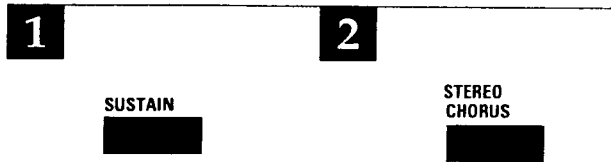

DRUM Assignment

Key	Instrument name
G2	Bass Drum
G#2	Rim Shot
A2	Low Snare
A#2	Hi Clap
B2	Hi Snare
C3	Synthe Percussion 1
C#3	Hi-hat Close
D3	Low Tom
D#3	Low Clap
E3	Low Conga
F3	Hi-hat Open
F#3	Mid Tom
G3	Hi Conga
G#3	Crash Cymbal
A3	Hi Tom
A#3	Ride Cymbal
B3	Low Cymbal
C4	Synthe Percussion 2
C#4	Small Cymbal

The FS630 has two effects which can enhance sounds. Both are described below:

1. Sustain:

Sustain is an effect which lets notes "Sound" for a longer duration. The sustain effect is automatically on when the **POWER** switch of the FS630 is turned on. Pressing the **SUSTAIN** button cancels the effect. Pressing it a second time will turn the effect back on.

2. Stereo chorus:

Pressing the **STEREO CHORUS** button activates an effect which adds a deep stereo richness to the currently selected sound. Pressing the button a second time cancels the effect.

Note:

When you choose the stereo chorus effect the number of notes that can be heard at once will be reduced.

Using Hand Percussion

The keys can also be used to play percussion instruments.

First, select sound number 90 (DRUM SET) in "100 SOUND LIBRARY".

Now, when you press one of the keys on the keyboard, you will hear the sound of an assigned percussion instrument. This feature allows you to enjoy playing simple drum solos in time with the rhythm. The drum sounds are assigned to the keys on the Lower keyboard as shown by the picture above that key.

The keys of the Upper keyboard will also produce drum sounds--even though there are no pictures above them. The chart on the left shows you which drum sounds have been assigned to these keys. Note that "G2" means the second G key from the left side of the keyboard. "C3" is therefore the third C key from the left.

The chart shows 19 drum sounds assigned to keys G2 through C#4. Starting with the next note, D4, the same 19 drum sounds are assigned to the next 19 keys in identical order. Each of the 61 notes on the FS630 has a drum sound assigned to it--making the FS630 a pretty impressive drum set !

Getting Started with Rhythms

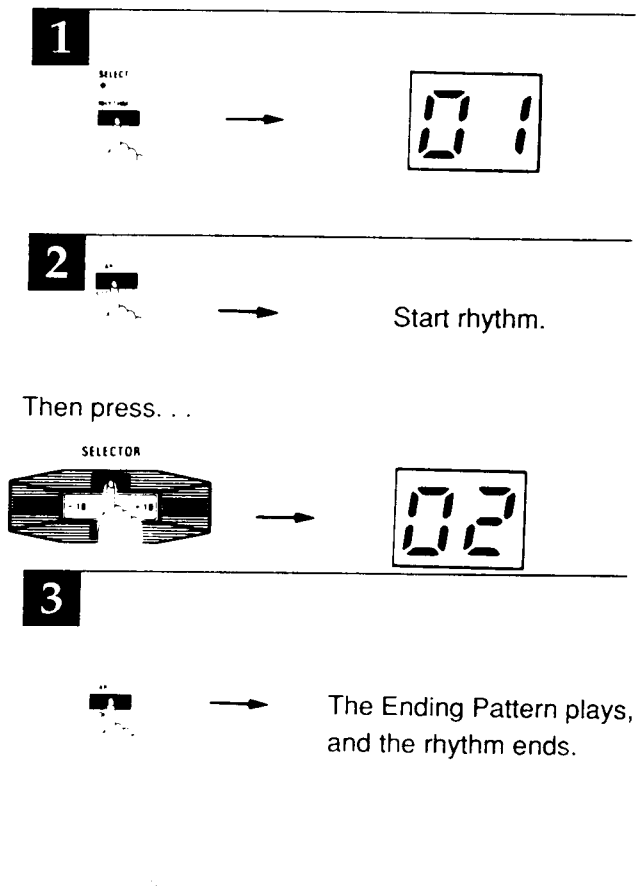

This section will show you how to select and play any of the rhythms listed under the "25 RHYTHMS" on the FS630's front panel.

1. Begin by pressing the **RHYTHM** button. The lamp above the button will light, and the display will change to read 01.
2. If you press the **START/STOP** button at this point, rhythm number 01 (DANCE) will begin to play (drums only). Now find the **SELECTOR** buttons and press the +1 button. The display will change to read 02 and the rhythm will change to number 02 (FUSION).

You may use the **SELECTOR** buttons in this way to select any rhythm you desire. The number in the display will change to indicate the number of the rhythm currently selected.

3. Next, press the **START/STOP** button. An ending pattern which matches the currently selected rhythm will play, and the rhythm performance will end. You can use this Ending Pattern to bring a song to a close. Or, if you want the rhythm to end without the Ending Pattern, you can press the **START/STOP** button quick two times.

Changing Rhythm Tempo



You can use the **TEMPO** buttons to change the tempo of the rhythm pattern. The **TEMPO ▼** button makes the tempo slower. The **TEMPO ▲** button makes the tempo faster. The longer you hold down each of these buttons, the more tempo will change.

Pressing either of the **TEMPO** buttons once--just after selecting a new rhythm--will change the tempo to a rate that suits that new rhythm. At this time, the display will briefly show the current tempo--within a range of 01 to 64. Then if necessary, you can use the **TEMPO** buttons to adjust the tempo further.

When you press and hold down either of the **TEMPO** buttons, the display will change to read *dn* (short for "down") or *UP* depending on which **TEMPO** button you are pressing. When the tempo reaches maximum (64) or minimum (01), the letters in the display (*dn* or *UP*) will disappear.

The small lamp at the bottom of the display will also blink in time with the tempo.

Using Auto-Accompaniment

Lower keyboard



1



2

3

Use

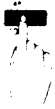

to start rhythm.



Lower keyboard

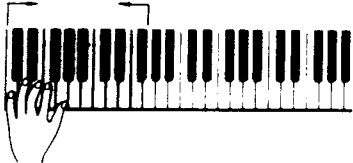

Auto-Accompaniment starts playing.

This Auto-Accompaniment mode allows you to create a realistic ensemble performance simply by pressing and holding left hand chords as you play the melody.

The nineteen keys on the left end of the keyboard (the Lower keyboard) are used to play the chords which control the Auto-Accompaniment. Up until now we have used the Lower keyboard only for normal keyboard operation. Here's how you can use the Lower keyboard notes to control Auto-Accompaniments:

1. First, prepare the Lower keyboard for chord use.

Press the **AUTO** button. The display will change briefly to read **AU**.

2. Start the rhythm.

Select a rhythm using the **RHYTHM** button and the **SELECTOR** buttons. Then, start the rhythm by pressing the **START/STOP** button.

3. Use the Lower keyboard to activate Auto-Accompaniments.

Try pressing one or more of the keys on the Lower keyboard. You should hear the Auto-Accompaniment begin to play.

The tempo of the Auto-Accompaniment can be controlled using the **TEMPO** buttons.

4. Auto-Accompaniment chords will change as you press different keys in the Lower keyboard. The Chord Table on page 12 will show you which notes can be played to generate specific chords.

Using ONE FINGER AD-LIB for an ad-lib performance

By now you've become familiar with the Auto-Accompaniment function of the FS630. But you may be wondering what you can do to spice up the melody a bit. Well, the ONE FINGER AD-LIB function is just for you! This exclusive feature separates KAWAI keyboards from all others.

1. What is ONE FINGER AD-LIB?

ONE FINGER AD-LIB is a patented feature which allows anyone, any level of musical ability, to sound like a "pro". With the touch of a finger, you can play hundreds of impressive ad-lib melodies with full Auto-Accompaniment and chord progressions. It's great fun!

The ONE FINGER AD-LIB phrases are determined by the rhythm you select. For example, there are funky ad-lib phrases for rhythm number 03 (FUNK), and some exciting rock'n roll phrases that go well with number 08 (50'S ROCK). There are seventeen ONE FINGER AD-LIB phrases preset for each of the FS630's 25 rhythms--a total of 425 phrases in all !

2. How does ONE FINGER AD-LIB work?

- Use the **RHYTHM** button and the **SELECTOR** buttons to select a rhythm. Next, press the **ONE FINGER AD-LIB** button. The small dot lamp on the lower right side of the display will light up.
- Now, press and hold down one of the keys in the ONE FINGER AD-LIB section of the keyboard (shown in the drawing at left). By holding down a single key, you can play an entire ad-lib phrase! Try other ONE FINGER AD-LIB keys. Note that each key plays a different phrase.

2-a

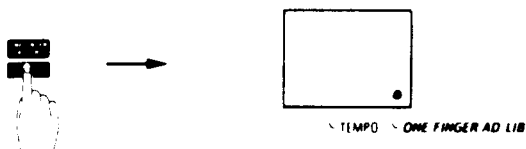

2-b

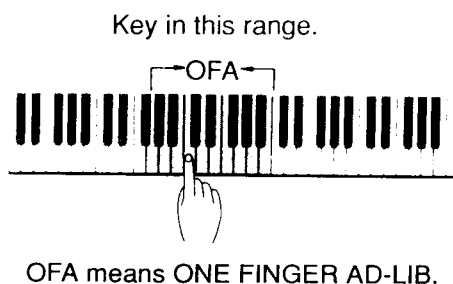

Using ONE FINGER AD-LIB for an ad-lib performance

- c) Next, you can add Rhythm and Auto-Accompaniments. Press the **AUTO** button. The display should change briefly to read **AL**.
Start the Rhythm using the **START/STOP** button. The Rhythm and Auto-Accompaniment should begin to play. Listen closely! Notice that the Auto-Accompaniment chords are changing automatically. The FS630 has been programmed so that each Rhythm is accompanied by an authentic sounding chord progression that plays automatically.
- d) Now hold down one of the keys in the **ONE FINGER AD-LIB** section of keyboard. The ad-lib phrase will play. If you hold the **AD-LIB** key down for a long time, you'll notice that the phrase changes automatically with the chord progression!
- e) If you decide that you'd like to change the preset chord progression, play any chord on the Lower keyboard. This will override the preset progression. The **ONE FINGER AD-LIB** phrase will then change to match the chords you play with your left hand.
- f) To return to the preset chord progression, press the **ONE FINGER AD-LIB** button twice. This turns the **ONE FINGER AD-LIB** function off and then back on again--restoring the preset chord progression.

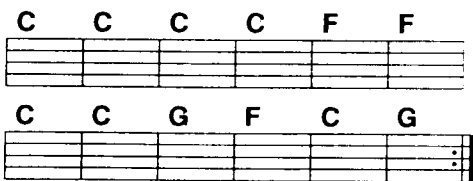

A note about the ONE FINGER AD-LIB chord progressions.

When you start the Auto-Accompaniment with the **ONE FINGER AD-LIB** function turned ON, the chord progression that plays is in the key of C. For example, the progression for rhythm number 08 (50'S ROCK) is as shown left.

The next page will show you how to change the key of the **ONE FINGER AD-LIB** chord progression.

Using ONE FINGER AD-LIB for an ad-lib performance

1-2



1-3

Press  to start Auto-Accompaniment.

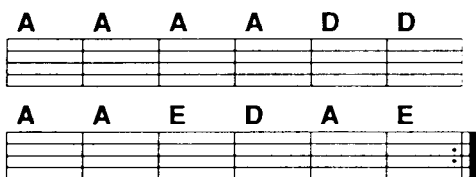

2-2

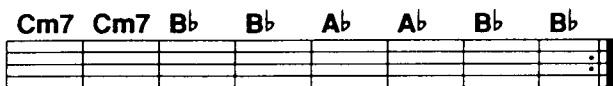

Changing Keys

- Those of you who won't be happy unless the chord progression for 50'S ROCK is in the key of "A" should perform the following operation (after stopping the rhythm for a moment):
 - Check to be sure that the **ONE FINGER AD-LIB** button and the **AUTO** button have both been turned ON.
 - Before starting the rhythm, press the A key shown in the illustration at left.
 - Then press the **START/STOP** button to start the Rhythm and Auto-Accompaniment. The chord progression should now be as shown left.
- Some of you might be happier if the chord progression for 50'S ROCK were in a minor key. To do this, you can perform an operation like the one described below (again, you should stop the rhythm first):
 - Check to be sure that the **ONE FINGER AD-LIB** button and the **AUTO** button have both been turned ON.
 - Play a Cm chord as shown in the illustration at left.
 - Then press the **START/STOP** button to start the Rhythm and Auto-Accompaniment. The chord progression should now be as shown left.

There are two ONE FINGER AD-LIB chord progressions for each Rhythm -- one in a major key and one in a minor key. If you would prefer the chord progression to play in the key of Am, just perform the operation above playing an Am chord instead of the Cm chord we used as an example.

Now select different Rhythms and begin exploring the 425 ONE FINGER AD-LIB phrases built into the FS630!

Using the SYSTEM Functions

1

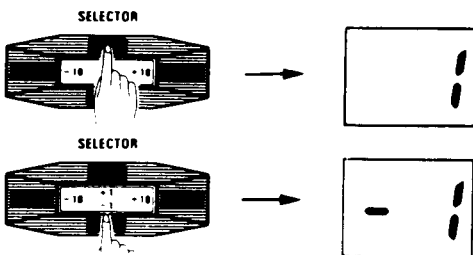
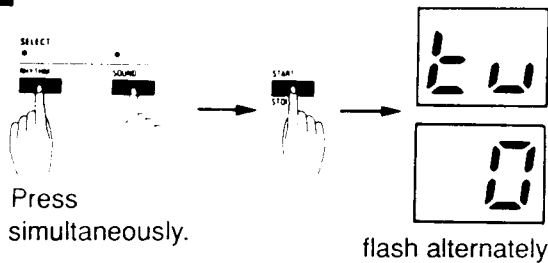

2

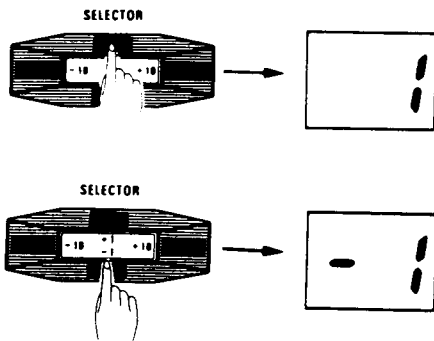
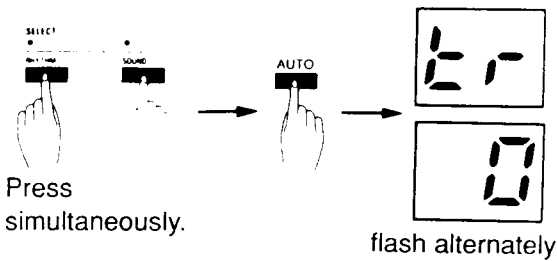

In this section we will outline the FS630's SYSTEM functions (which are concerned with the overall control of the FS630).

SYSTEM functions

The SYSTEM functions include:

1. TUNING CONTROL (pitch adjustment)

Press both the RHYTHM button and the SOUND button simultaneously. Then press the START/STOP button. The display should begin to flash, alternately showing the letters **TU** (short for TUNE) and the number **0**.

If you press the SELECTOR +1 button once, the number in the display will change to read **1** and the pitch will raise slightly. If you press the -1 button instead, the number will change to **-1** and the pitch will drop. You can use the TUNE function to adjust the FS630's pitch within a range of -8 to 7.

2. TRANSPOSE (key change)

Press both the RHYTHM button and the SOUND button simultaneously. Then, press the AUTO button. The display will begin to flash, alternately showing the letters **TR** (short for TRANSPOSE) and the number **0**.

If you press the SELECTOR +1 button, the number in the display will change to read **1** and the pitch will raise by a half step. If you press the -1 button instead, the number will change to **-1** and the pitch will drop by a half step. You can use the TRANSPOSE function to adjust the FS630's pitch by a maximum of nine half steps up or down (range -9 to 9).

The SYSTEM MODE will be canceled if you press any button other than those used in SYSTEM MODE operation (SELECTOR buttons, START/STOP button or AUTO button).

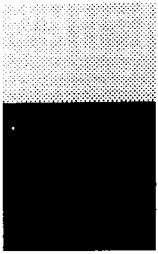

Chord Table

How to play chords that FS630 can recognize (C root)

C Major 	C Major 	C Major 	C (+5) 	C (-5) 	CM7 	CM7 	
C7 	C7 	C7 	C dim 	Csus4 	C6 	C9 	C13
C minor 	C minor 	Cm7 	Cm7 	Cm7 (-5) 	CmM7 	Cm9 	C-13

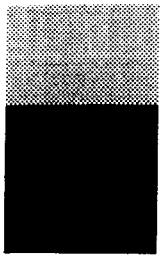

Specifications

FS630

Keyboard:	61 keys, Standard full-size
Sounds:	100
Rhythms:	25
Effects:	Stereo Chorus, Sustain
Rhythm controls:	START/ENDING & STOP TEMPO
Volume controls:	MASTER Volume
Miscellaneous controls:	ONE FINGER AD-LIB DEMO
Speakers:	12 cm x 2 (Stereo)
Rated voltage:	9-12 V DC: six size C dry cell batteries or power adaptor (PS-121 or PS-123)
Accessory jacks:	DC (9-12 V) IN STEREO PHONES
Accessories:	Six size C dry cell batteries Music Rest

KAWAI

Kawai Musical Instruments Manufacturing Co., Ltd.
200 Terajima-cho, Hamamatsu, Japan

OW311E

Printed in Japan