

KAWAI DATACAT

Owner's Manual

■ Thank you for purchasing the Kawai MIDI keyboard DATACAT!

This Owner's Manual contains valuable information that will help you make full use of this instrument's many capabilities. Read it carefully and keep it handy for future reference.

■ FEATURES

Complete MIDI Controls in Slim & Compact Body

37-note mid-size keyboard, 2 WHEELs, 8 function switches, and LED are all provided in DATACAT's small body. These allow you to quickly and easily control any MIDI messages.

Support for MIDI Bank Select

MIDI standards can handle 12,384 (128 x 128) banks, each composed of 128 programs. The DATACAT can send full pairs consisting of MSB for the bank (control change No. 0) of 0 to 127 and LSB for the bank (control change No. 32) of 0 to 127, enabling selection of all bank numbers.

Assignable Controller WHEEL

In addition to the BENDER WHEEL, the DATACAT also contains an independent WHEEL to control another MIDI message. You can select and assign one from over 100 types of messages (MODULATION, VOLUME, PANPOT, DAMPER PEDAL, etc.) to the WHEEL.

■ Care and Maintenance

Your DATACAT is a delicate musical instrument. To prevent breakdowns and ensure years of reliable, trouble-free service, shield it from:

- Direct sunlight and exposure to the elements
- Extremes in temperature or humidity
- Dusty environment
- Vibration...especially during transport
- Make sure that all power switches are off before changing equipment connections.
- Check all equipment connections before applying the power.

Cleaning

- Clean the instrument with a soft cloth, a mild detergent, and lukewarm water.
- Never use harsh or abrasive cleansers or organic solvents.

NOTE: This equipment has been tested and found to comply with the limits for a class B digital device, pursuant to Part 15 of the FCC Rules. These limits are designed to provide reasonable protection against harmful interference in a residential installation.

This equipment generates, uses and can radiate radio frequency energy and, if not installed and used in accordance with the instructions, may cause harmful interference to radio communications. However, there is no guarantee that interference will not occur in a particular installation. If this equipment does cause harmful interference to radio or television reception, which can be determined by turning the equipment off and on, the user is encouraged to try to correct the interference by one or more of the following measures:

- Reorient or relocate the receiving antenna.
- Increase the separation between the equipment and receiver.
- Connect the equipment into an outlet on a circuit different from that to which the receiver is connected.
- Consult the dealer or an experienced radio/TV technician for help.

This digital apparatus does not exceed the Class B limits for radio noise emissions from digital apparatus set out in the Radio interference Regulations of the Canadian Department of Communications.

■ CONTENTS

■ FEATURES	1
■ Care and Maintenance	1
■ CONTENTS	2
■ Preparation before using	2
■ SPECIFICATIONS	3
■ Name of Parts	4
■ Setting the MIDI TRANSMIT channel (MIDI CH)	6
■ Sending a PROGRAM CHANGE number (PROG)	7
■ BANK SELECT	8
■ BENDER (PITCH BEND) WHEEL	9
■ WHEEL ASSIGN (WHEEL)	10
■ RESET ALL CONTROLLERS	11
■ GM RESET	11
■ OCTAVE SHIFT	12
■ TRANSPOSE	13
■ SYSTEM EXCLUSIVE FORMAT	14
■ MIDI IMPLEMENTATION CHART	15

■ Preparation before using

- Connect the DATACAT and other MIDI equipments.

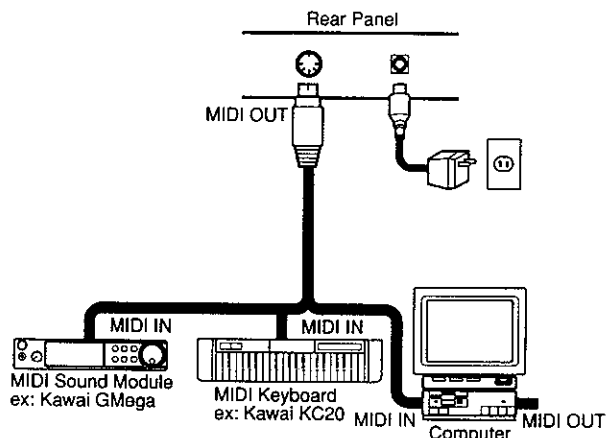

- Turn the DATACAT's power on.

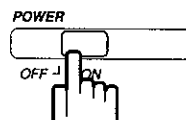

- Turn all other equipments' power on.

Connecting the Power Supply

Your keyboard can use either your home AC power outlet or dry cell batteries as a power source.

■ To insert batteries:

1. Turn the unit over and remove the battery cover.
2. Insert six Size "AA" dry cell batteries. Be sure they are aligned in the proper direction.
3. Replace the battery cover.

⚠ *As the batteries begin to run down, the LED will begin to blink slowly (approximately every four seconds). At that time, you should replace all six of the batteries.*

Do not mix battery types (or new batteries with old ones), as this may cause problems such as battery fluid leakage.

Remove the batteries when not using the keyboard for long periods of time.

■ To Use An AC Power Outlet:

Connect a PS-092 adaptor (available separately) to the adaptor terminal on the rear panel of the keyboard. Then, connect the adaptor to a wall socket.

⚠ *We recommend that you use a KAWAI AC adaptor (9-volt/500 mA) with the DATACAT. If you decide to use a universal adaptor from another manufacturer, please be sure of the following:*

1. The voltage selector should be set at 9-volts.
2. The polarity selector must be set to "negative" (-) polarity, otherwise the keyboard will not operate (or will run on batteries until the batteries are drained).
3. The adaptor must have 0.5 Amp (A).

SPECIFICATIONS

KEYBOARD	37 Keys
CONTROLS	SWITCHES (WHEEL, PROG, MIDI CH, BANK MSB, OCTAVE SHIFT, TRANSPOSE) ASSIGNABLE WHEEL, BENDER (PITCH BEND) WHEEL, LED
FUNCTIONS	SETTING THE MIDI TRANSMIT CHANNEL (1 - 16), WHEEL ASSIGN, OCTAVE SHIFT, TRANSPOSE, SENDING A PROGRAM CHANGE NUMBER (0 - 127), BANK SELECT (0 - 16,384), RESET ALL CONTROLLERS, GM RESET
JACKS	DC IN, MIDI OUT
DIMENSIONS (mm)	496 (W) x 197 (D) x 62 (H)
WEIGHT (kg)	1.6

Name of Parts

Top View

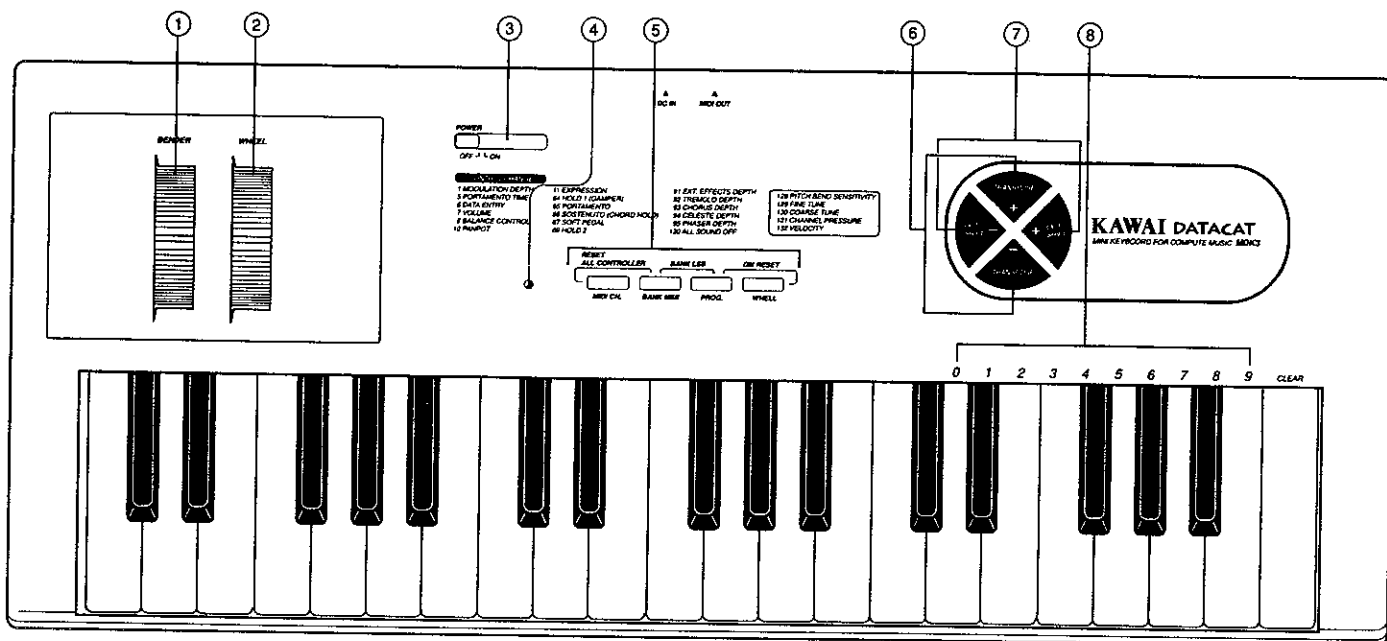

Rear View

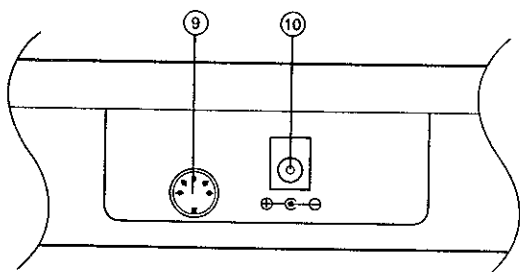

-
- ① **BENDER (PITCH BEND) WHEEL**
Sends MIDI PITCH BEND messages to connected MIDI instruments.
 - ② **WHEEL**
The control information on p.10 is assigned to this WHEEL.
 - ③ **POWER button**
Turns the DATACAT's power on and off. When the power is turned on, the LED lamp on the front panel will light.
 - ④ **LED**
Ensures you if the values are properly entered. If you are using batteries which are reaching the end of their lifespan, the LED will begin to blink slowly (approximately every four seconds). At that time you should replace all six of the batteries.
 - ⑤ **FUNCTION SWITCHES**
These are pressed to set various functions (BANK, or WHEEL assignments; PROGRAM NUMBER transmission; MIDI TRANSMIT channel; RESET ALL CONTROLLERS; or GM reset).
 - ⑥ **TRANSPOSE SWITCHES**
Used to set the TRANSPOSE value, and to shift the DATACAT's pitch by one octave higher and lower.
 - ⑦ **OCTAVE SHIFT SWITCHES**
Used to set the TRANSPOSE value, and to shift the DATACAT's pitch up to four octaves higher and lower.
 - ⑧ **Numeric Keys**
Used to set the value for all functions. If you make a mistake, press the CLEAR key and enter the correct value from scratch.
 - ⑨ **MIDI OUT Jack**
Outputs all of DATACAT's MIDI messages. Use a MIDI cable to connect the DATACAT to other MIDI devices.
 - ⑩ **DC IN Jack**
This jack is used to connect Power Adaptor (Kawai PS-092) available separately.

⚠ *See page 3 for special instructions if you are using a universal AC adaptor or other brand of adaptor.*

Of course, the keys in the Numeric keys section named above also function as a normal keyboard when you are not in the settings mode.

1 Setting the MIDI TRANSMIT channel

Set the DATA CAT's MIDI TRANSMIT channel. The DATA CAT sends all MIDI messages on this channel. Be sure to match the channel with the RECEIVE channel of connected equipment.

1. Hold down MIDI CH switch. The LED begins to flash very quickly for a moment, and then flashes rather slowly (approx. every half second) showing that you can change the channel.
2. Press the Numeric Keys (at the right end of the keyboard) to change the channel (1 to 16). Each time you press the Numeric Key, the LED will flash very quickly for a moment, and then flashes rather slowly (approx. every half second). If you make a mistake, press the CLEAR key, and then enter the correct value from scratch.

(Examples) ● While holding down the MIDI CH switch ... Press the "2" key to select channel 2.

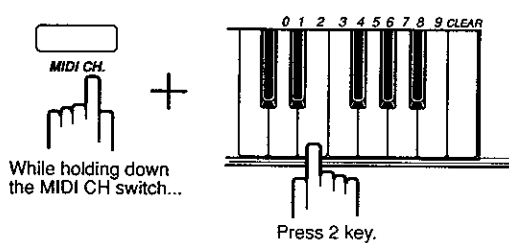

● While holding down the MIDI CH switch ... Press the "1" and then "6" key to select channel 16.

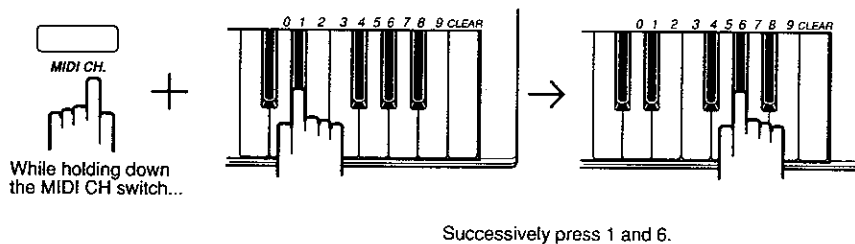

3. Release the MIDI CH switch. Now the new TRANSMIT CHANNEL is set on DATA CAT. (LED returns as before pressing MIDI CH switch.)

Notes:

- ★ When the DATA CAT's power is turned off and then on again, the TRANSMIT CHANNEL 1 is automatically set.
 - ★ When you activate functions (ex. HOLD, MODULATION) and select new MIDI CHANNEL, some unexpected effects like stuck notes or vibrato may remain on the old MIDI channel. In that case, re-select the old MIDI channel and then turn off the effects using the WHEEL ASSIGN function or use RESET ALL CONTROLLERS function (see page 11).
 - ★ If you do not enter any value, or enter a value other than 1 to 16, TRANSMIT CHANNEL does not change.
-

2 Sending a PROGRAM CHANGE number (PROG)

Using the PROG switch and the Numeric Keys, you can send any MIDI PROGRAM CHANGE 0 – 127

1. Hold down the PROG switch. The LED begins to flash very quickly for a moment, and then flash rather slowly (approx. every half second) showing that you can set value.
2. While holding down the PROG switch, press the Numeric Keys to set the PROGRAM CHANGE number to be sent.

<Examples>

● PROGRAM CHANGE number 0

While holding down the PROG switch, press “0” key.

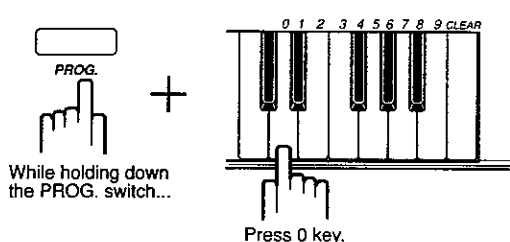

● PROGRAM CHANGE number 64

While holding down the PROG switch, press “6” and “4” keys.

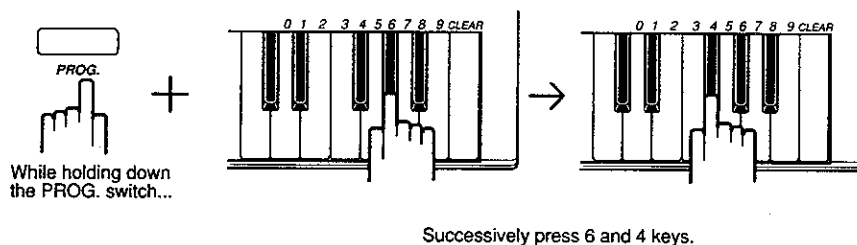

● PROGRAM CHANGE number 123

While holding down the PROG switch, successively press keys “1”, “2”, and “3”.

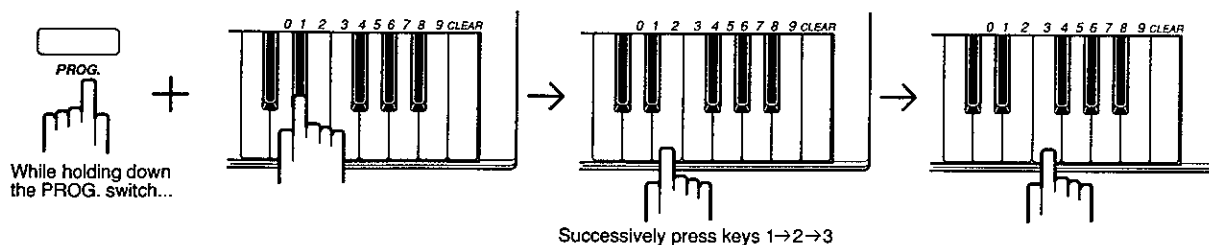

Note:

★ When setting a two or three-digit number, do not release the PROG switch until the entry of the last digit has ended completely.

-
3. Release the PROG switch.
The PROGRAM CHANGE message is sent to connected equipment.

- Notes:
- ★ The PROGRAM CHANGE number you set here does not remain if the DATACAT's power is turned off.
 - ★ This function is effective only when the receiving instrument is equipped with the program change function.
-

3 Bank Select

Bank Select transmits control change No. 0 (MSB) and No. 32 (LSB) as a pair.

-
- ★ The MSB and the LSB each have 128 possible settings (from 0 to 127). This makes for 16,384 (128 x 128) available Bank Select settings.
Bank number usage varies from one manufacturer to another.
Some manufacturers effect switching by varying the LSB with no change in the MSB.
For example, (MSB, LSB): (0,0), (0,1),..., (0,127).
Others set the LSB at 0 (zero) and effect changes by varying the MSB.
For example, (MSB, LSB): (0,0), (1,0),..., (127,0).
Devices from KAWAI such as the KC20 and GMega LX are of the first type, using banks (0,0) and (0,7).
-

- Note:
- ★ These specifications are effective only when the receiving instrument is equipped with the bank function.
-

■ Setting the CONTROLLER 0 (BANK MSB)

1. Hold down the BANK MSB switch. The LED begins to flash very quickly for a moment, and then flash rather slowly (approx. every half second) showing that you can set value.
2. While holding down the BANK MSB switch, press the Numeric Keys to set the BANK MSB number to be sent.

- Note:
- ★ When setting a two or three-digit number, do not release the BANK MSB switch until the entry of the last digit has ended completely.
-

-
3. When the BANK MSB switch is released, the following data are sent in sequence.
 - (1) The BANK MSB value you have set in step 2.
 - (2) The last BANK LSB value you had set (see the following section for details). If you have not set the BANK LSB after turning on the DATACAT'S power, the value for the BANK LSB is "0".
 - (3) The last PROGRAM CHANGE value you had set (see page 7 for details). If you have not set the PROGRAM CHANGE value after turning on the DATACAT'S power, value "0" is automatically sent.

For example, if you set the PROGRAM CHANGE number 5, BANK LSB value 0, and then select BANK MSB value 3, the MSB and LSB pair (3,0), and the PROGRAM CHANGE number 5 are sent in sequence. When you do this, the fifth tone of the third bank of the receiving instrument is called up.

Note: ★ The BANK MSB number you set here does not remain if the DATACAT's power is turned off.

■ Setting the CONTROLLER 32 (BANK LSB)

1. Hold down the switch and switch simultaneously. The LED begins to flash very quickly for a moment, and then flash rather slowly (approx. every half second) showing that you can set value.
2. While holding down the BANK MSB switch and PROG switch simultaneously, press the Numeric Keys to set the BANK LSB number to be sent.

Note: ★ When setting a two or three-digit number, do not release the and switches until the entry of the last digit has ended completely.

3. When the BANK MSB and PROG switches are released, the following data are sent in sequence.
 - (1) The last BANK MSB value you had set. If you have not set the BANK MSB after turning on the DATACAT's power, the value for the BANK MSB is "0".
 - (2) The BANK LSB value you had set.
 - (3) The last PROGRAM CHANGE value you had set (see page 7 for details). If you have not set the PROGRAM CHANGE value after turning on the DATACAT'S power, value "0" is automatically sent.

For example, if you set the PROGRAM CHANGE number 5, BANK MSB value 0, and then select BANK LSB value 7, the MSB and LSB pair (0,7), and the PROGRAM CHANGE number 5 are sent in sequence. When you do this, the fifth tone of the seventh bank of the receiving instrument is called up.

Note: ★ The BANK LSB number you set here does not remain if the DATACAT's power is turned off.

4 BENDER (PITCH BEND) WHEEL

Moving the BENDER WHEEL transmits MIDI BENDER (PITCH BEND) messages to connected equipment. This allows you to bend the pitch of sound up (or down) to personalize your performance.

1. To bend up the pitch:
Move the BENDER WHEEL away from you.
2. To bend down the pitch:
Move the BENDER WHEEL towards you.

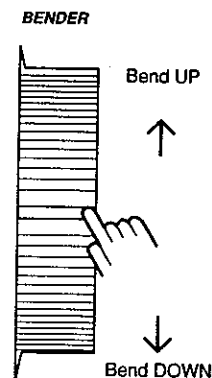

5 WHEEL ASSIGN (WHEEL)

The DATACAT can assign various types of control information to the WHEEL, and then transmit that information when the WHEEL is rotated.

In this mode, rotating the WHEEL determines what kind of information is to be transmitted. The following control number list is a typical example.

CONTROL NUMBER LIST

1	Modulation Depth	91	Ext. Effects Depth
5	Portamento Time	92	Tremolo Depth
6	Data Entry	93	Chorus Depth
7	Volume	94	Celeste Depth
8	Balance Control	95	Phaser Depth
10	Panpot	120	All Sound Off
11	Expression	128	Pitch Bend Sensitivity
64	Hold 1 (Damper)	129	Fine Tune
65	Portamento	130	Coarse Tune
66	Sostenuto (Chord Hold)	131	Channel Pressure
67	Soft Pedal	132	Velocity
69	Hold 2		

Note:

- ★ The DATACAT can assign any one of control number from 0 to 127 (except for the followings) to the WHEEL.

0 or 32 (Bank Select), 96 to 101, 122 to 127

Instead, you can assign PITCH BENDER SENSITIVITY, FINE TUNE, COARSE TUNE, CHANNEL PRESSURE, or VELOCITY function by entering a value from 128 to 132 with the step 2 below.

Now let's try assigning control number 10 "PAN (pan pot)" to the WHEEL for the DATACAT.

PAN (Pan Pot)

If the receiving sound source module or synthesizer is equipped with this pan pot function, the sound can be shifted to the left or right with this control information.

1. While holding down the WHEEL switch, use the Numeric Keys (0-9) to input 10. The LED begins to flash very quickly for a moment, and then flash rather slowly (approx. every half second) showing that you can set value.

Note:

-
- ★ When setting a two or three-digit number, do not release the WHEEL switch until the entry of the last digit has ended completely.
-

2. Releasing the WHEEL switch completes the setting.

Notes:

-
- ★ When the power to the unit has been turned off and then on again, the WHEEL function is set for MODULATION.
 - ★ The settings that have been shown are effective only when the receiving instrument is equipped with these functions.
 - ★ When setting control number 132, you can use the WHEEL to set the velocity value for the note information that is sent now.
 - ★ Parameter numbers 120 (ALL SOUND OFF) and 121 (RESET ALL CONTROLLERS) are sent by rotating the WHEEL farther than its central position to enable the minimum value.
-

6 RESET ALL CONTROLLERS

Simultaneously press the **MIDI CH** and **BANK MSB** switches to transmit the RESET ALL CONTROLLERS message. To help prevent valuable settings from being reset accidentally, the reset is carried out about 2 seconds after the MIDI CH and BANK MSB switches are pressed simultaneously.

Note:

-
- ★ The function described above is effective only when the receiving instrument is equipped with the receive function for RESET ALL CONTROLLERS messages.
-

7 General MIDI RESET

Simultaneously pressing the **PROG** and **WHEEL** switches initializes the General MIDI function of the receiving instrument (GM ON). To help prevent valuable settings from being reset accidentally, the reset is carried out about 2 seconds after the PROG and WHEEL switches are pressed simultaneously.

Note:

-
- ★ The function described above is effective only when the receiving instrument is equipped with the receive function for GM System On messages.
-

8 OCTAVE SHIFT

This shifts the pitch of the keyboard up or down by one, two, or three octaves. Transmission is normally within the range of note numbers 48 to 84, but if you shift the pitch one octave higher, the transmission note numbers will be 60 to 96.

This function allows you to control MIDI note No. 0 to 127.

1. To shift the pitch one octave higher: (MIDI note No. 60 - 96)
Press the **OCT. SHIFT +** switch once.
2. To shift the pitch two octaves higher: (MIDI note No. 72 - 108)
Press the **OCT. SHIFT +** switch once more.
3. To shift the pitch three octaves higher: (MIDI note No. 84 - 120)
Press the **OCT. SHIFT +** switch once more.
4. To shift the pitch four octaves higher: (MIDI note No. 96 - 127)
Press the **OCT. SHIFT +** switch once.
5. To shift the pitch one octave lower: (MIDI note No. 36 - 72)
Press the **OCT. SHIFT -** switch once.
6. To shift the pitch two octaves lower: (MIDI note No. 24 - 60)
Press the **OCT. SHIFT -** switch once more.
7. To shift the pitch three octaves lower: (MIDI note No. 12 - 48)
Press the **OCT. SHIFT -** switch once more.
8. To shift the pitch four octaves lower: (MIDI note No. 0 - 36)
Press the **OCT. SHIFT -** switch once.

Note:

★ Turning the power off always resets the shifted pitch to NORMAL pitch.

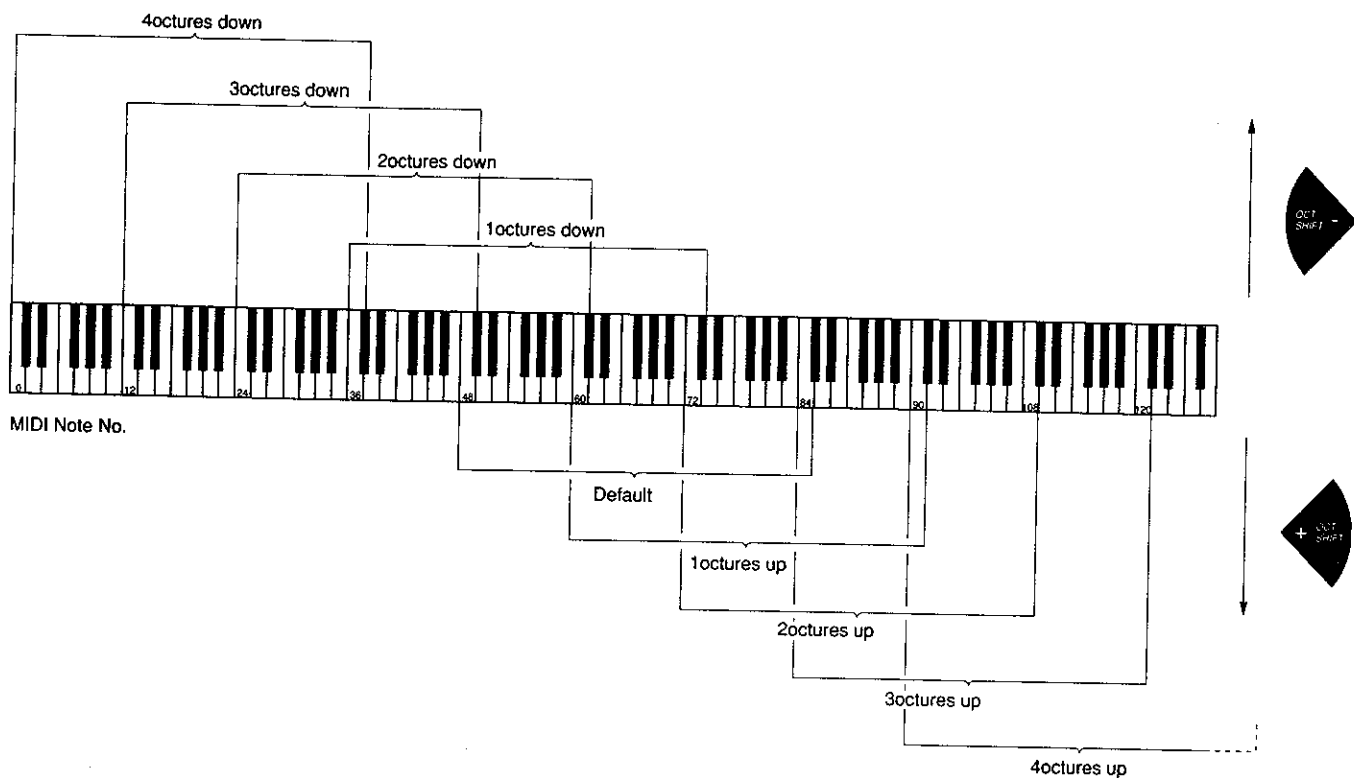

9 TRANSPOSE

This function shifts the entire pitch of the DATACAT in semitone units.
 You can transpose the pitch by 24 half steps (12 higher / 12 lower).

1. Press the **TRANSPOSE +** or **TRANSPOSE -** switch to transpose the pitch up or down a half-step.
 The setting can be made within the range of 12 (+12) to -12 (-12).

Notes:

- ★ A set TRANSPOSE value is reset to "0" (zero) by switching the power off and then on again.

DATA CAT MIDI IMPLEMENTATION

1. TRANSMITTED DATA

1st	2nd	3rd	Description	
1001nnnn	0kkkkkkk	0vvvvvvv	Note on/off	kkkkkkk= 0~127 vvvvvvv= 0 off vvvvvvv= 1~127 on
1011nnnn	00000000	0vvvvvvv	BANK Select MSB	vvvvvvv= 0~127
1011nnnn	00100000	0vvvvvvv	LSB	vvvvvvv= 0~127
1011nnnn	0ccccccc	0vvvvvvv	Control Change	ccccccc= 1~31 = 33~95 = 102~119 vvvvvvv= 0~127
1011nnnn	01100100	000000vv	RPN LSB	vv= 0:Pitch Bend Sensitivity = 1:Fine Tuning = 2:Coarse Tuning
1011nnnn	01100101	00000000	RPN MSB	
1011nnnn	01111000	00000000	All Sound off	
1011nnnn	01111001	00000000	Reset all Controllers	
1100nnnn	0ppppppp	-----	Program Change	ppppppp= 0~127
1101nnnn	0vvvvvvv	-----	Ch. Pressure	vvvvvvv= 0~127
1110nnnn	00000000	0vvvvvvv	Pitch Bender	vvvvvvv= 0~127
11111110	-----	-----	Active Sensing	

nnnn=Channel no.
RPN Registered Parameter Number

2. EXCLUSIVE TRANSMITTED DATA

Turn General MIDI System On

Status	11110000	F0H	System exclusive
ID No.	01111110	7EH	Non-Real time
device ID	01111111	7FH	
Sub-ID #1	00001001	09H	General MIDI message
Sub-ID #2	00000001	01H	General MIDI On
EOX	11110111	F7H	

MIDI Implementation Chart

Function		Transmitted	Remarks
Basic Channel	Default Changed	1 1 - 16	
Mode	Default Messages Altered	— × *****	
Note Number	True Voice	0 - 127 *****	
Velocity	Note ON Note OFF	○ 9n, V=1 - 127 × 9n, V=0	
After Touch	Key's Channel's	× ○	WHEEL ASSIGN ONLY
Pitch Bend		○	
Control Change	0, 32	○	BANK SELECT RPN *1
	1 - 31	○	
	33 - 63	○	
	64 - 95	○	
	100, 101 102 - 121	○ ○	
Program Change	True	0 - 127 *****	
System Exclusive		○	
Common	: Song Position	×	
	: Song Select	×	
	: Tone	×	
System Real Time	: Clock	×	
	: Commands	×	
Aux Messages	: Local ON/OFF	×	
	: All Notes OFF	×	
	: Active Sense	○	
	: Reset	×	
Notes		*1 RPN #0=Pitch Bend, Sensitivity #1=Fine Tune #2=Coarce Tune Data Entry MSB used for value tran.	

KAWAI

Kawai Musical Inst.
Mfg. Co. Ltd.
Printed in Japan

OW617E-G 94 02