

**KAWAI**

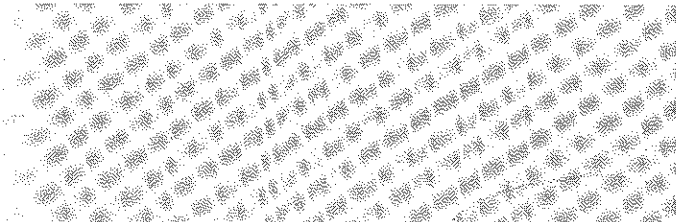

**KML-**

**Instruction Manual**  
**SG SYSTEM**  
**KAWAI MUSIC LESSON**

**WARNING:** This equipment generates, uses, and can radiate radio frequency energy. If not installed and used in accordance with the instruction manual, it can cause interference to radio communications. The rules with which it must comply afford reasonable protection against interference when used in most locations. However, there can be no guarantee that such interference will not occur in a particular installation. If this equipment does cause interference to radio or the related equipment off and on, the user is encouraged to try correct the interference by one or more of the following measures:

- reorient the receiving antenna.
- move the receiver away from the instrument.
- plug the instrument into a different outlet so that it and receiver are on different branch circuits.
- consult the dealer or a qualified service personnel.

## MAIN CHARACTERISTICS

- **Easy to operate**

Even first-time users will find the Kawai KML-SG system easy to operate.

- **Modular design**

Up to 16 students can be instructed using just one KML-SG. By connecting two KML-SG's, up to 32 students can be instructed.

- **Ensemble function**

Students can be divided into groups of two, four or eight for ensemble playing.

- **Monitor function**

The instructor can listen to (monitor) the student without disturbing the performer. Students can be monitored individually or in designated groups.

- **Instruction function**

Piano performances and voice instruction can be sent back-and-forth between instructor and student(s) via the headphone/microphone set.

## CONTENTS

1. SYSTEM CONFIGURATION .....	1
2. MAJOR PARTS AND THEIR FUNCTIONS .....	2
3. CONNECTION METHOD .....	5
4. HOW TO USE PANEL SWITCHES .....	6
5. EXPANSION UNIT .....	15



# 1. SYSTEM CONFIGURATION

- Master unit (KML-SG)

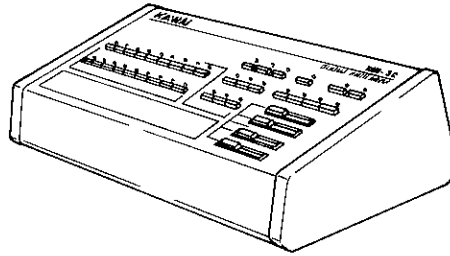

- Attachment (KML-SGS)

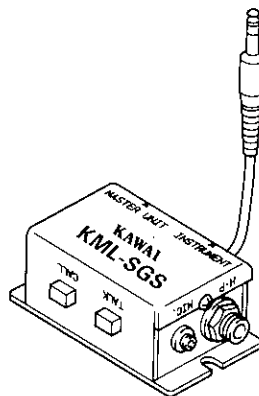

- Connector cable 5m (KML-CA4)  
10m (KML-CA5)

- Headphone-microphone set (ST-1MF)

- AC adaptor

- Connector cable (between KML-SG and instructor's instrument)

- Expansion cable

# 2. MAJOR PARTS AND THEIR FUNCTIONS

## ■ Master Unit (KML-SG)

(Front Panel)

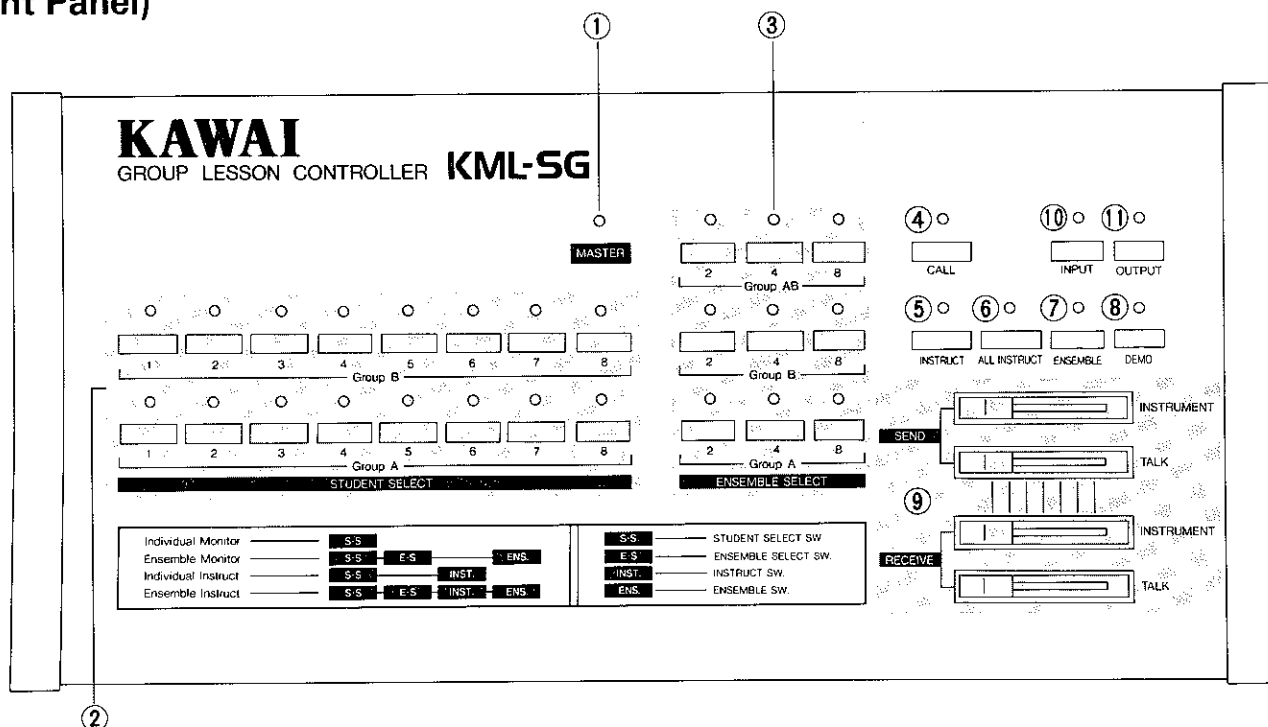

### ① MASTER Indicator

Lights when the power is on. When two KML-SG's are connected, only the MASTER LED on the main unit will light.

## ■ Student Select Section

### ② STUDENT SELECT Switches

Selects the individual or group to be monitored or instructed.

## ■ Ensemble Select Section

### ③ ENSEMBLE SELECT Switches

Allows instructor to select the students' ensemble formation. (For details on ensemble formation, see "Ensemble Monitor" on page 6.)

## ■ Instruction Formation Section

### ④ CALL Switch

Activates a CALL tone when the instructor wishes to summon the attention of a student.

### ⑤ INSTRUCT Switch

Used when instructing individuals or groups.

### ⑥ ALL INSTRUCT Switch

Used when instructing all students.

### ⑦ ENSEMBLE Switch

Used when monitoring and instructing the students' group performance.

### ⑧ DEMO Switch

Used to allow the performance(s) or voice(s) of a specified student or group to be monitored by the rest of the students.

### ⑨ VOLUME Slide Control

Used to adjust the volume of instructor/student performances and voice instruction.

### ⑩ INPUT Switch

Used when sending sounds from external equipment to the students headsets. (e.g. drum machines or record players).

### ⑪ OUTPUT Switch

Used when sending performance or microphone sounds from the students to external audio or amplifying equipment.

## (Rear Panel)

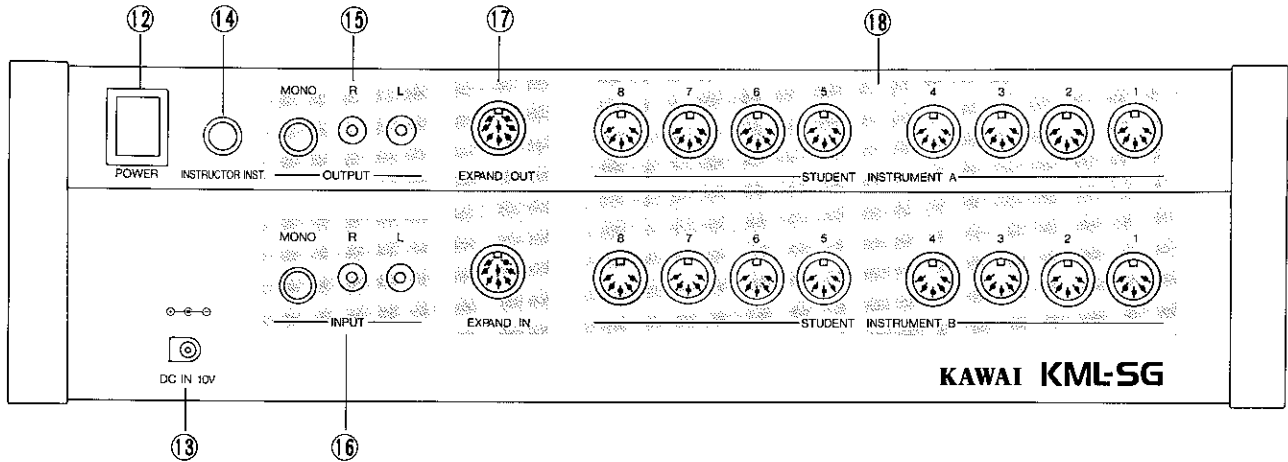

### ⑫ POWER Switch

Switches the power of KML-SG on and off.

### ⑬ DC IN Jack Terminal

Connects the accessory AC adaptor.

### ⑭ INSTRUCTOR INST.

Connects the headphone terminal of the instructor's instrument with the connector cable.

### ⑮ OUTPUT

Connects the INPUT jack of an external device to the Master Unit for output to external audio or amplifying equipment.

### ⑯ INPUT

Connects the OUTPUT jack of an external device (such as a Drum Machine or Record player) to the Master Unit for transmission to student and instructor headsets.

### ⑰ EXPAND IN/EXPAND OUT

EXPAND OUT of the master (main unit) and EXPAND IN of the slave (sub-unit) are connected with the expansion cable when using two KML-SG's in combination.

### ⑱ STUDENT INSTRUMENT

Connected to the Master Unit via the student attachment (KML-SGS) and the dedicated cable (KML-CA4 or KML-CA5). The numbers for each input terminal correspond to the numbers on the STUDENT SELECT Switches on the Front Panel.

## ■ Left-side (MIC/HEADPHONE jack)

Connects the teacher's headphone-microphone set.

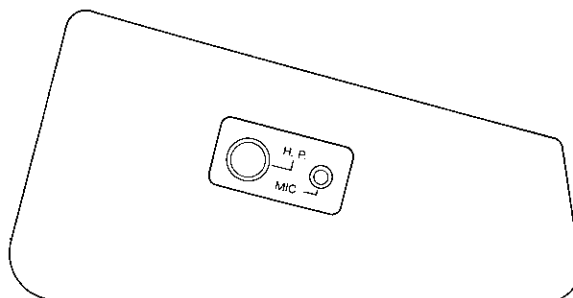

## ■ Attachment for student (KML-SGS)

---

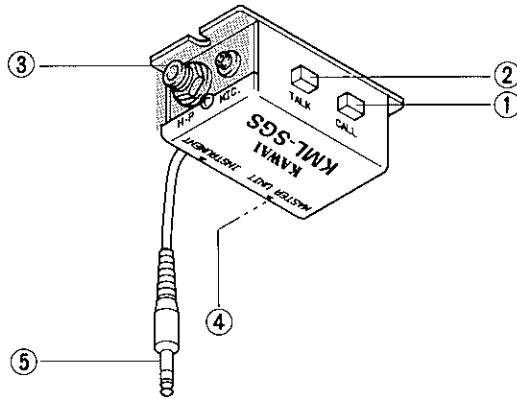

**① CALL Switch**

Press when you want to talk to the instructor.

**② TALK ON/TALK OFF**

Press to converse through the microphone.

**③ MIC/HEADPHONE Jack**

Connects the student's headphone-microphone set.

**④ Jack (Connecting Master Unit (KML-SG))**

A dedicated cable (KML-CA4 or KML-CA5) connects this jack with the Master Unit (KML-SG).

**⑤ Cable (Connecting Student's Instrument)**

Connects the headphone jack of the student's instrument to the KML-SGS attachment.



# 3. CONNECTION METHOD

Referring to the illustration below, connect the Master Unit (KML-SG) and the AC adaptor, the students' attachments (KML-SGS), the instructor's instrument, and the headphone set.

## ■ Master Unit (KML-SG)

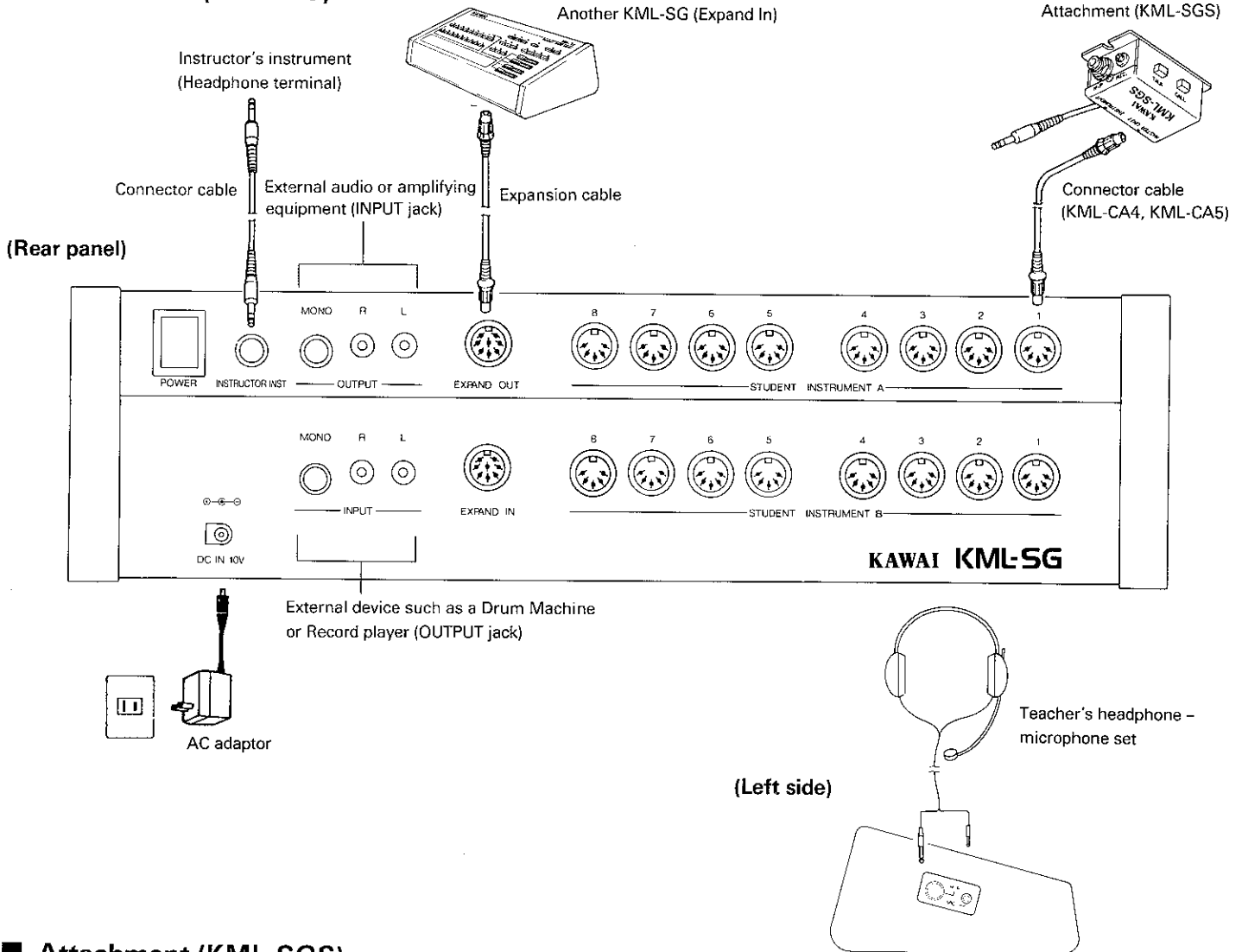

## ■ Attachment (KML-SGS)

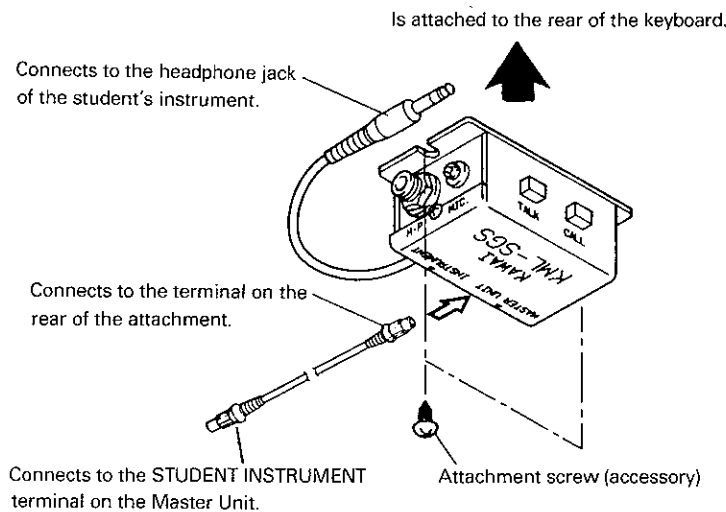

# 4. HOW TO USE PANEL SWITCHES

## 1 Individual Monitor

### ■ STUDENT SELECT Switch

- (1) Press the switch on the STUDENT SELECT section corresponding to the student you wish to monitor. (You may monitor several students at the same time.)

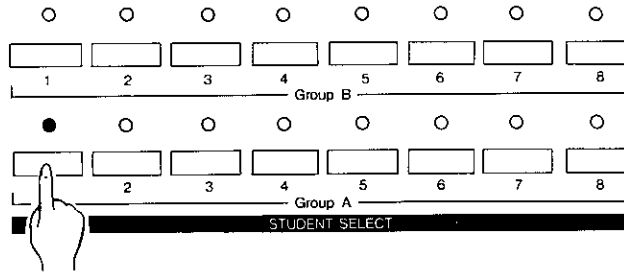

The LED above the STUDENT SELECT switch you have pressed will light, and you will be able to monitor that student's performance or voice response.

\* The student cannot hear the performance or microphone sounds of the instructor.

- (2) When you press the switch again, the LED goes out and the monitor status is canceled.

## 2 Ensemble Monitor

### ■ ENSEMBLE SELECT Switch, ENSEMBLE Switch

- (1) Selects the student group configuration from the ENSEMBLE SELECT section.  
(For the group configuration, see next page.)

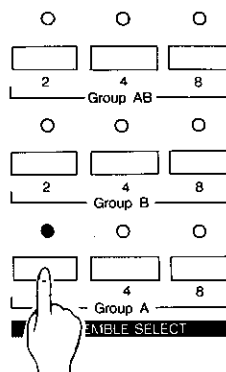

When the LED above the ENSEMBLE SELECT switches are lit, performance and microphone sounds can be sent and received within each group of students.

● **Note:** Performance and microphone sounds may not be sent or received between groups.

\* Examples of student group configurations are illustrated below.

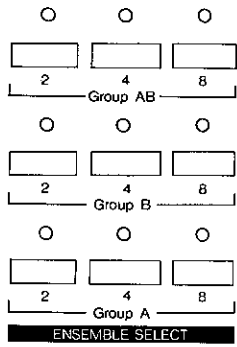

← The common group configuration of Group AB can be selected with priority by pressing afterward. To cancel, press again or select the Group A or Group B group configuration.

← Selects the Group B group configuration. To cancel, press again or select the Group AB group configuration.

← Selects the Group A group configuration. To cancel, press again or select the Group AB group configuration.

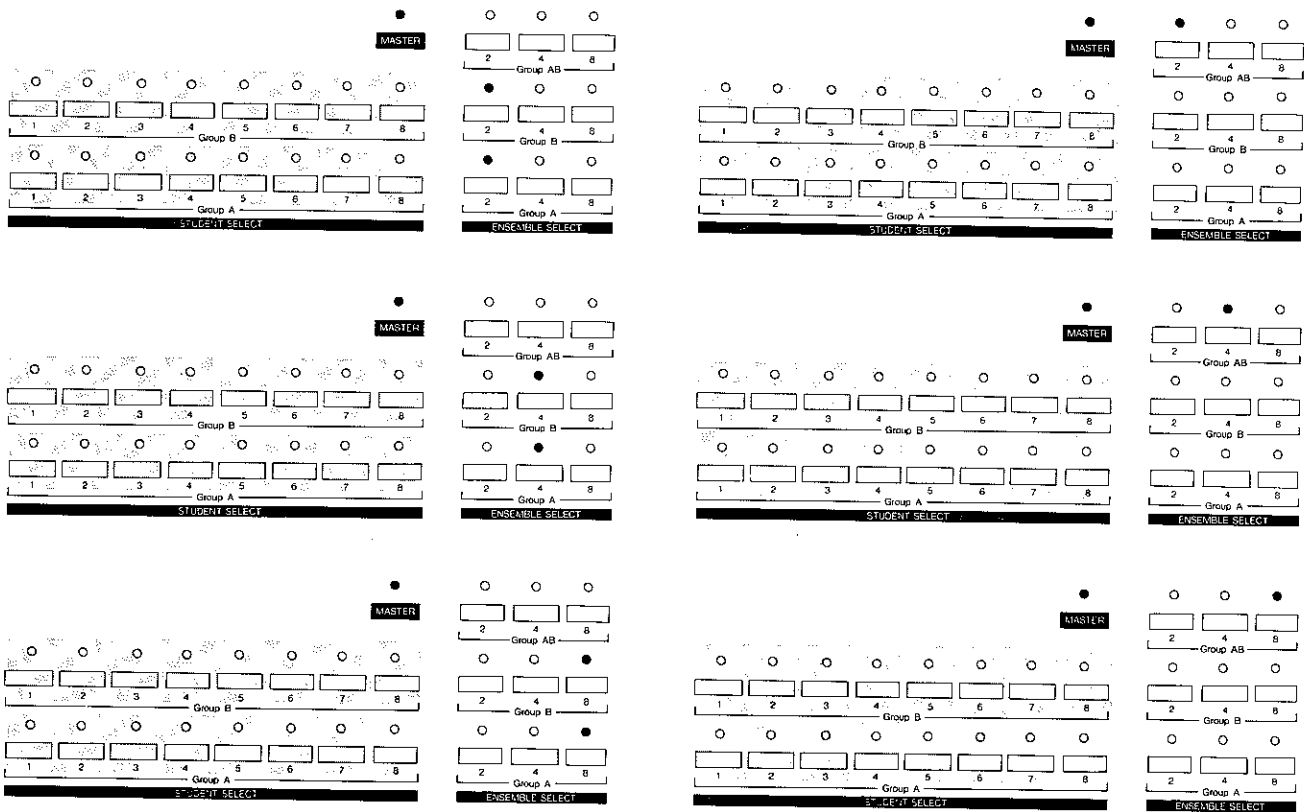

(2) Press the ENSEMBLE switch on the Instruction Formation Section.

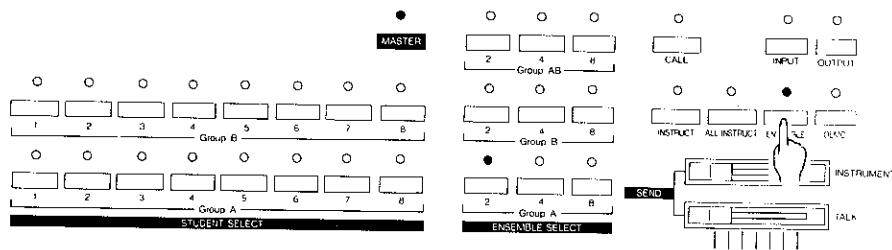

(3) Press the switch on the STUDENT SELECT section for any student in the group configuration.

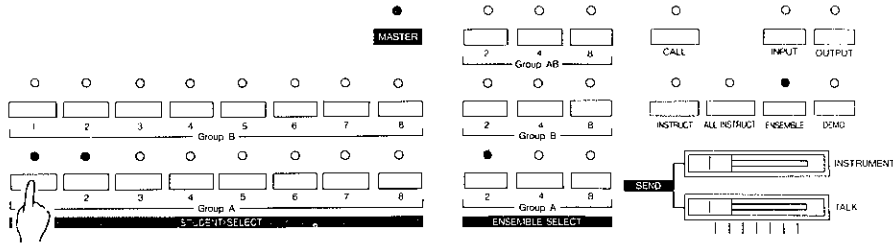

The LED's will light, and the performance and voice responses of all group members can be monitored. (LED's will light above the STUDENT SELECT switches for each student in the corresponding group.)

- Notes:**
- Operations (1), (2) and (3) can be performed in any order.
  - When you press one of the STUDENT SELECT switches, without pressing the ENSEMBLE switch, you can monitor one student playing in ensemble.

### 3 Individual Instruct

#### ■ INSTRUCT Switch

- (1) On the STUDENT SELECT section, press the switch corresponding to the student you wish to instruct.
- (2) Press the INSTRUCT switch.

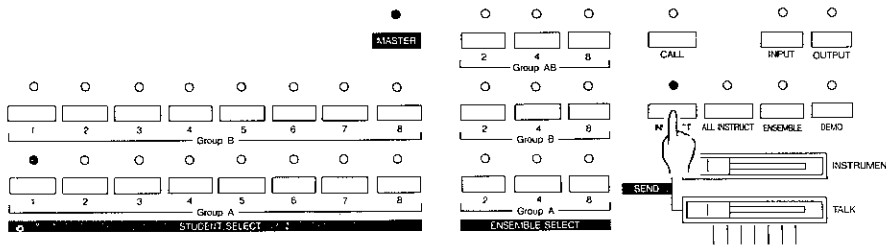

Performance and voice response can be sent and received between the instructor and selected student.

- (3) Press the INSTRUCT switch again. The LED will go out. The system returns to monitoring status.

## 4 Group Instruct

- (1) Configuration of a student group is selected on the ENSEMBLE SELECT section.
- (2) Press the ENSEMBLE switch.
- (3) On the STUDENT SELECT Section, press the switches of any students to be included in the group. The LED's of all the students in the corresponding group will light.
- (4) Press the INSTRUMENT switch.

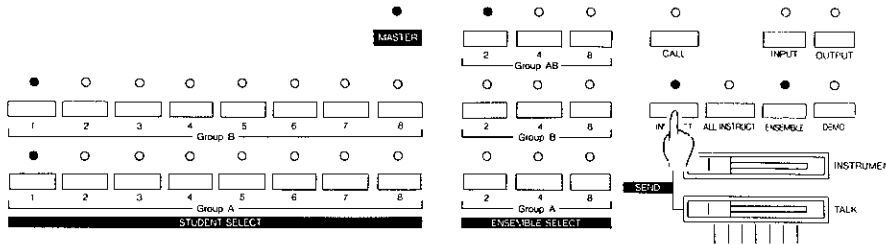

Performance and microphone sounds can now be sent and received between the instructor and the group.

- Notes:**
- Operations (1), (2), (3) and (4) can be performed in any order.
  - To instruct just one member of the group, leave the ENSEMBLE switch in the "off" position.

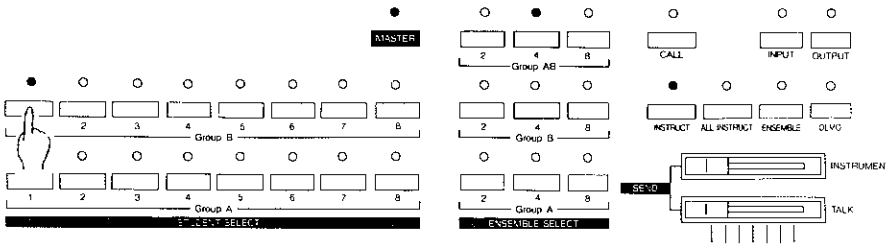

Now, performance and voice response can still be sent and received between the students in the group — but the student being instructed will lean only the instructor's voice and performances.

- (5) Press the INSTRUMENT switch again. The LED will go out. The system returns to monitoring status.

## ■ ALL INSTRUCT Switch

Enables performances and voice response to be sent and received between the instructor and all students.

(1) Press the ALL INSTRUCT switch.

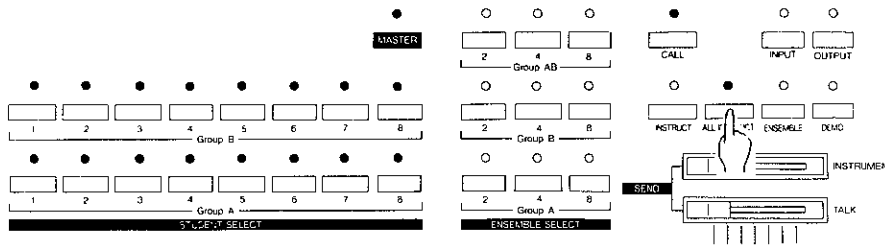

The ALL INSTRUCT LED, all LED's in the STUDENT SELECT section, as well as the CALL LED will light.

While CALL LED is lit, all the students will hear a “peep-peep” call sound. As soon as this LED goes out, all students will be able to receive and send performance and microphone sounds to and from the instructor.

● **Note:** Students cannot send and receive performance and microphone sounds among themselves.

(2) Press this switch once again to cancel the ALL INSTRUCT function.

When the LED goes off, the system returns to the status it was in before the ALL INSTRUCT switch was pressed.

## 5 OTHER OPERATIONS

### ■ CALL Switch (on Master Unit)

Used to call the student's attention.

(1) On the STUDENT SELECT section, press the switch corresponding to the student to be called.

- **Note:** With ENSEMBLE SELECT, a group configuration can be selected. Press the ENSEMBLE switch and the corresponding group will be called.

(2) Press the CALL switch.

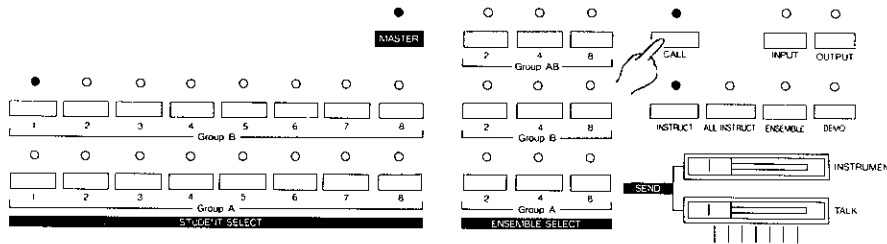

The LED lights, and the students will hear a “peep-peep” sound. At the same time, the LED above the INSTRUCT switch will light, and performance and voice responses can be sent and received between instructor and students.

Some moments later the CALL LED goes off.

### ■ DEMO Switch

The performance and voice response of a specified student or group can be monitored by all the other students.

(1) On the STUDENT SELECT section, press the switch corresponding to the specified student.

- **Note:** With ENSEMBLE SELECT, a group configuration can be selected. Press the ENSEMBLE switch and the corresponding group can be monitored.

(2) Press the DEMO switch.

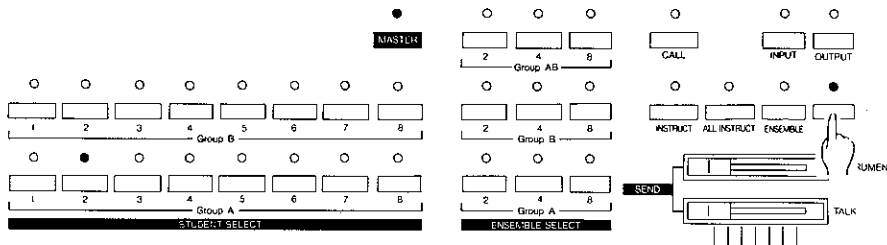

The LED will light, and all students will be able to monitor the performance and microphone sounds of the specified student or group.

- **Note:** When monitoring the performance and voice responses of several students with the ENSEMBLE SELECT switch on, the performing students will not be able to send and receive performance and microphone sounds among themselves unless they belong to the same group.

If the DEMO switch is pressed without pressing the STUDENT SELECT switch, the instructor’s performance and microphone sounds will be sent to all students. (The instructor will not be able to hear the students’ performance and voice responses, however.)

- (3) Press the switch again to cancel this function.

## ■ INPUT Switch

(See section 3. “CONNECTION METHOD” on page 5 for connecting external equipment.)

Sends sounds from external equipment (such as drum machines and record players) to specified students and groups, or all students.

The INPUT switch is used when students monitor the instructor’s model performance combined with external instruments, or when students perform in combination with external instruments.

- (1) Press the INPUT switch.

- **Note:** In this state, only the instructor can hear the sound of external equipment.

- (2) Press the appropriate switch(es) on the STUDENT SELECT section.

- **Note:** With ENSEMBLE SELECT, a group configuration can be selected. Press the ENSEMBLE switch for the corresponding group.

- (3) Press the INSTRUCT switch.

(To send the sound to all students, press the ALL INSTRUCT switch.)

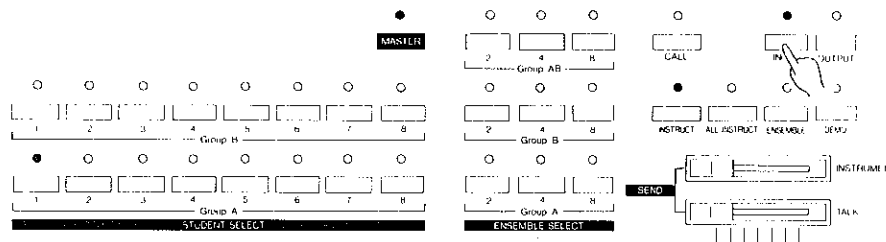

The sound of the external equipment is sent to the specified students, group, or all students.

- **Note:** Adjust the volume of SEND INSTRUMENT to an appropriate listening level.
- **Note:** Operations (1), (2) and (3) can be performed in any order.

- (4) Press the INPUT switch again to cancel this function.





(3) When the response to the student is completed, press the switch that is lit.

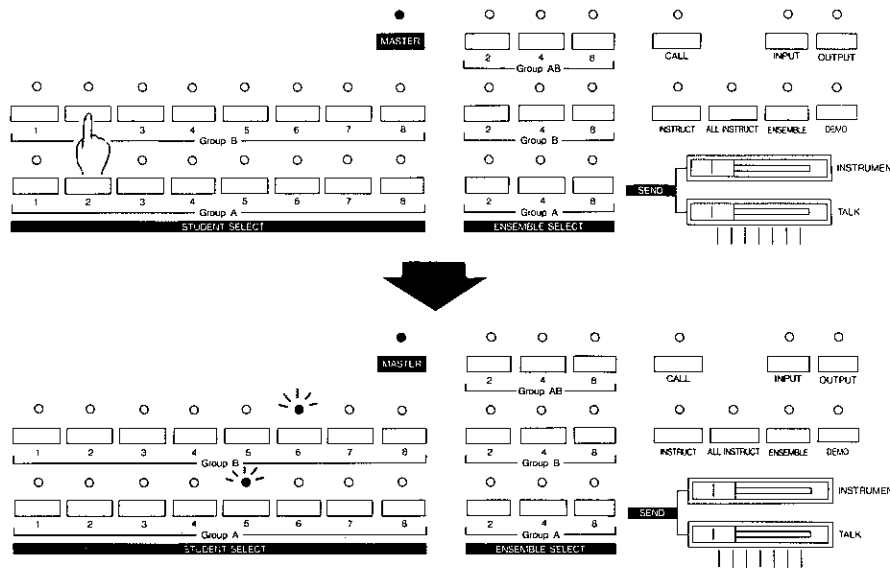

The student's LED goes off, and the CALL response is completed. All functions will return to their status before the CALL response.

● **Note:** When several CALL signals are sent from students, those students' LED on the Master Unit will blink. The instructor can respond to one CALL at a time. During CALL response, the LED's of the other students will go off. At the end of CALL response, the other students' LED's will begin to blink again.

## ■ VOLUME

### (1) SEND

Adjusts the volume of the instructor's performance and microphone sounds.

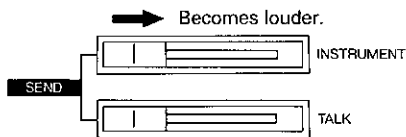

Adjusts the volume of the performance sound sent to the students.

Adjusts the volume of the microphone sound sent to the students.

### (2) RECEIVE

Adjusts the volume of the students' performance and voice response.

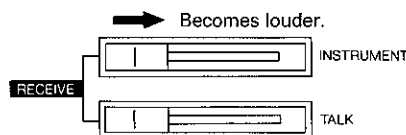

Adjusts the performance sound sent from the students.

Adjusts the microphone sound sent from the students.

● **Note:** When the volume of the instruments within one student group is not fixed, adjust VOLUME for each student's instrument.

# 5. EXPANSION UNIT

Up to 32 students can be accommodated by connecting two KML-SG's.

(1) Using the expansion cable, connect EXPAND OUT of the master (main unit) with EXPAND IN of the slave (sub-unit). (See Section 3. "CONNECTION METHOD" on page 5.)

- **Note:** Connect the instructor's headphone/microphone set to the master (main unit).

(2) Turn on the POWER switches for both units.

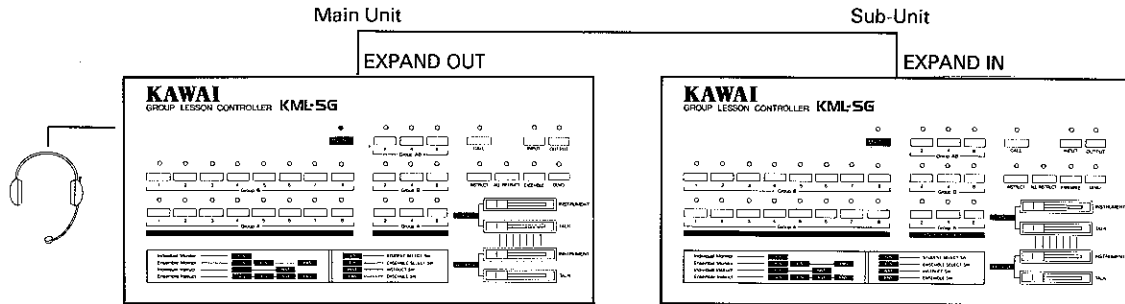

- **Note:** Only the MASTER LED for the master unit will light, not the slave (sub-unit).

(3) All operations except STUDENT SELECT are controlled from the master.

## 1 To monitor students on the slave side

On the slave unit, press the STUDENT SELECT switch for the corresponding student.

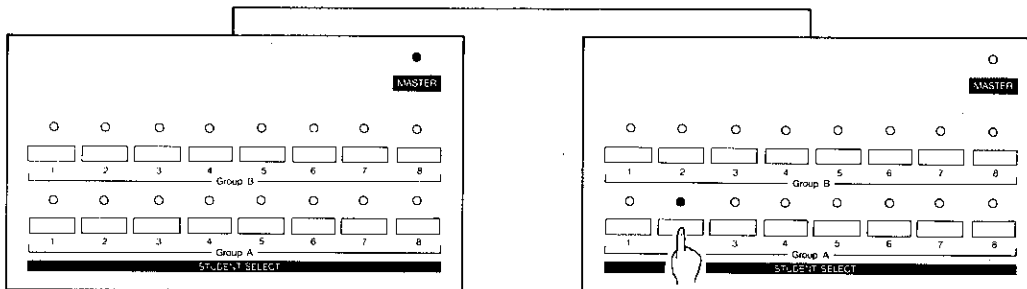

## 2 To monitor group ensemble status for the slave unit

(1) Select the group configuration with ENSEMBLE SELECT on the master unit.

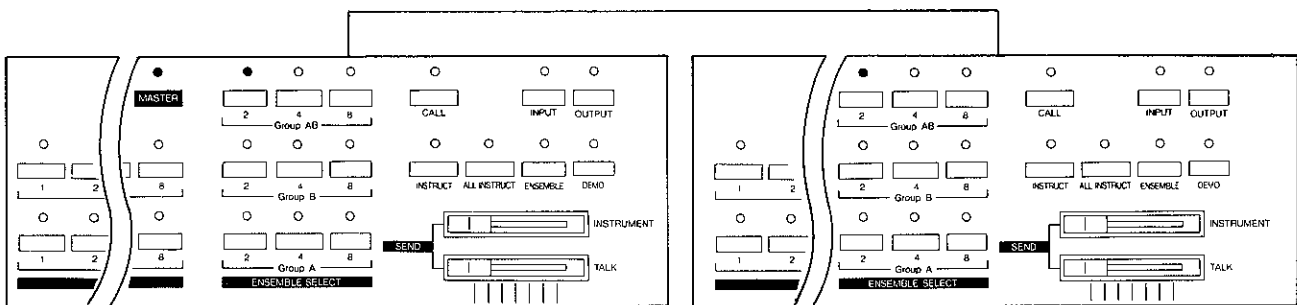

- **Note:** The group configuration on the slave unit is identical to that on the master. (See section 4. "HOW TO USE PANEL SWITCHES" on page 6 for details about the ENSEMBLE SELECT switch.)

To create separate group configurations for the master and slave, select the group configuration for the slave with ENSEMBLE SELECT on the slave.

(2) Press the ENSEMBLE switch on the master unit.

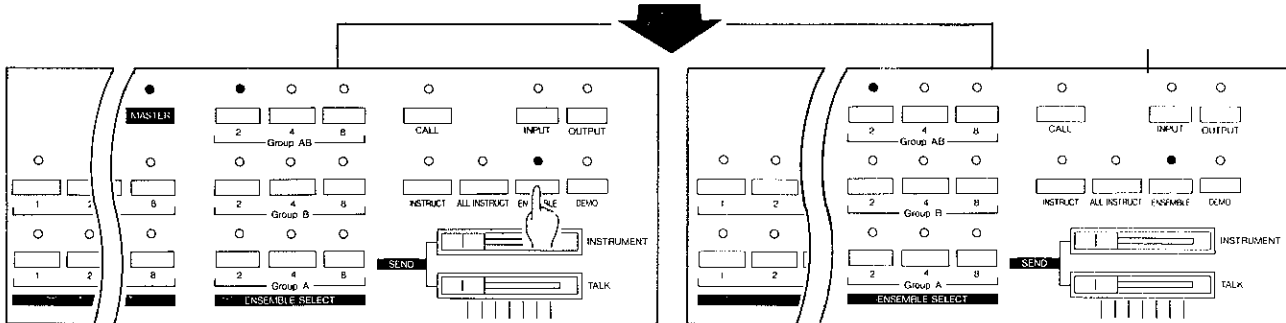

(3) Press the switch for one of the students on the slave unit STUDENT SELECT group to be configured.

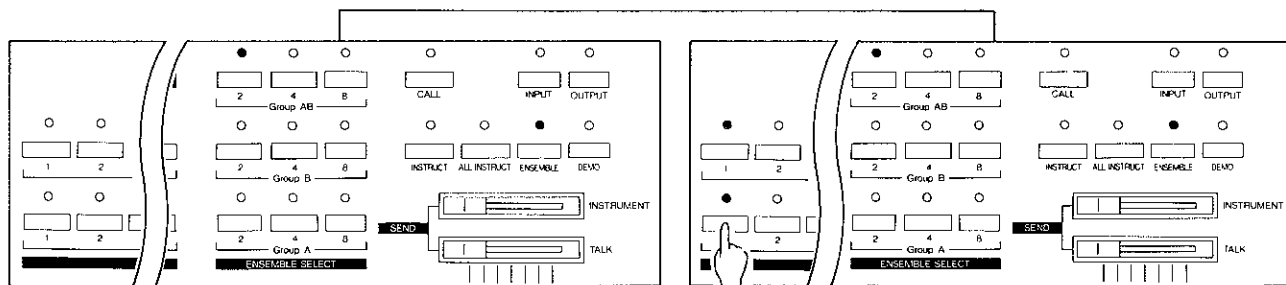

LED's will light above the STUDENT SELECT switches of all students in the corresponding group(s).

### 3 To instruct specific students or groups on the slave unit

After selecting the STUDENT SELECT switches on the slave, press the INSTRUCT switch on the master.

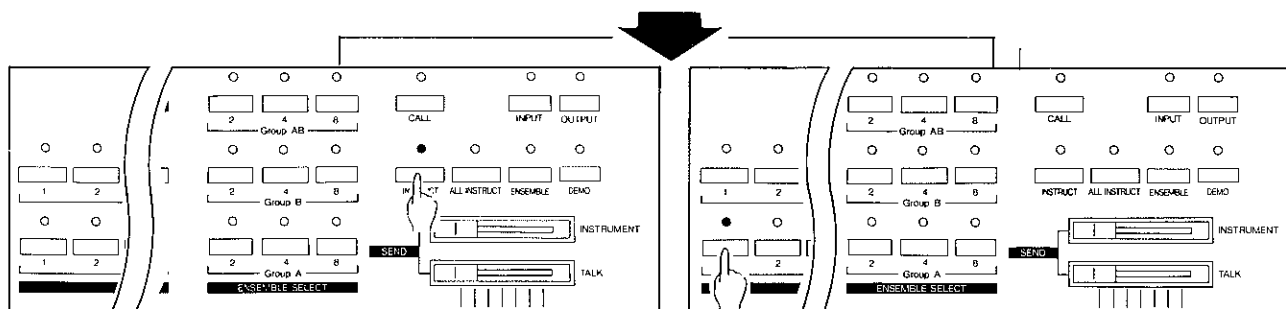

The instructor can then send and receive performance and voice responses to and from specified students or groups.

- Notes:**
- Press the ENSEMBLE SELECT and ENSEMBLE switch on the master, and the corresponding group will be instructed.
  - Pressing the ALL INSTRUCT switch on the master unit enables instruction to all students.

#### Notes (For EXPANSION UNIT):

- The master unit also controls DEMO, INPUT, OUTPUT, and CALL.
- To create a separate status for the master and slave, control the slave side with switches on the slave side.

# KML-SG SPECIFICATIONS

<b>Number of Students</b>	16 (Expandable to 32)
<b>Performance Style</b>	Individual, Ensemble (2, 4, 8)
<b>Instruct Style</b>	Monitor, Instruct, All Instruct, Demo
<b>Other Controls</b>	Power Switch, Send Volume (Instrument, Talk), Receive Volume (Instrument, Talk), Input, Output, Call
<b>Jacks</b>	Student Instrument. (A1 ~ 8, B1 ~ 8), Expand In/Out, Instructor Instrument, Input (MONO, R, L), Output (MONO, R, L), DC In
<b>Dimensions (W x D x H)</b>	372 × 197 × 107 mm 14¾" × 7⅞" × 4¼"
<b>Weight</b>	3.2 kg 7 lbs
<b>Accessories</b>	Adaptor, Connector Cable (between KML-SG and instructor's instrument)

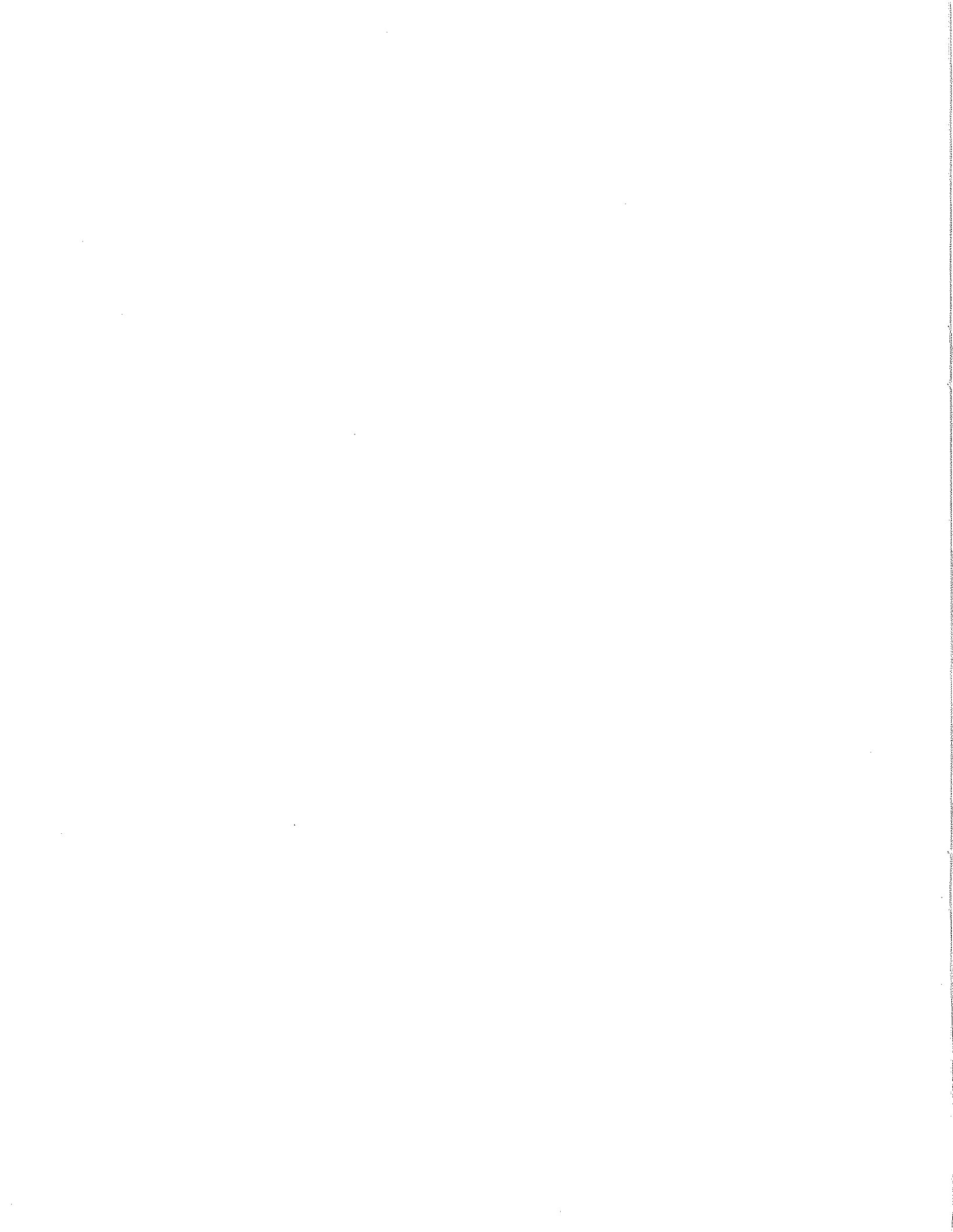



**KAWAI**