

**KAWAI**

**Digital Piano**

**CP67**

**Owner's Manual**

Thank you for choosing this Kawai CP67 Digital Piano.  
 Your new CP67 is a high-quality instrument offering the very latest in leading-edge music technology.  
 This manual contains valuable information that will help you make full use of your CP piano's  
 many capabilities. Please read it carefully and keep it handy for further reference.

## TABLE OF CONTENTS

	Page
Important Safety Instructions . . . . .	3
Assembling The Stand . . . . .	6
Part Names . . . . .	8
Getting Started	
1. Basic Operations . . . . .	12
2. Style . . . . .	14
3. Transpose . . . . .	15
4. Touch Response . . . . .	15
5. Demonstration Song . . . . .	16
6. Metronome . . . . .	16
Digital Recording Functions	
1. Easy Recording . . . . .	18
2. Playing Back A Song . . . . .	18
3. Advanced Recording/Playback Functions . . . . .	18
4. Deleting A Song/Track . . . . .	20
Concert Magic	
1. Selecting A Song . . . . .	21
2. Listening To The Song . . . . .	21
3. Performing A Song . . . . .	22
4. Concert Magic Song Arrangement Types . . . . .	22
5. Concert Magic Song Demo . . . . .	24
Function Mode	
1. Tuning . . . . .	25
2. Temperament . . . . .	25
3. MIDI Channel . . . . .	27
4. Transmit Program Change On/Off . . . . .	28
5. Local Control On/Off . . . . .	28
6. Channel Mute . . . . .	28
7. Sending Program Change Numbers . . . . .	29
MIDI . . . . .	30
List Of Preset Sound . . . . .	32
Style List . . . . .	33
Concert Magic Song List . . . . .	34
Specifications . . . . .	34
Demo Song List . . . . .	34
MIDI Implementation Chart . . . . .	35

# Important Safety Instructions

## SAVE THESE INSTRUCTIONS

INSTRUCTIONS PERTAINING TO A RISK OF FIRE, ELECTRIC SHOCK, OR INJURY TO PERSONS



**WARNING**  
TO REDUCE THE RISK OF FIRE OR ELECTRIC SHOCK, DO NOT EXPOSE THIS PRODUCT TO RAIN OR MOISTURE.

**AVIS : RISQUE DE CHOC ELECTRIQUE - NE PAS OUVRIR.**

TO REDUCE THE RISK OF ELECTRIC SHOCK, DO NOT REMOVE COVER (OR BACK). NO USER-SERVICEABLE PARTS INSIDE. REFER SERVICING TO QUALIFIED SERVICE PERSONNEL.



The lightning flash with arrowhead symbol, within an equilateral triangle, is intended to alert the user to the presence of uninsulated "dangerous voltage" within the product's enclosure that may be of sufficient magnitude to constitute a risk of electric shock to persons.



The exclamation point within an equilateral triangle is intended to alert the user to the presence of important operating and maintenance (servicing) instructions in the literature accompanying the product.

### Examples of Picture Symbols

	denotes that care should be taken. The example instructs the user to take care not to allow fingers to be trapped.
	denotes a prohibited operation. The example instructs that disassembly of the product is prohibited.
	denotes an operation that should be carried out. The example instructs the user to remove the power cord plug from the AC outlet.

Read all the instructions before using the product.

**WARNING - When using electric products, basic precautions should always be followed, including the following.**

**WARNING** Indicates a potential hazard that could result in death or serious injury if the product is handled incorrectly.

**The product should be connected to an AC outlet of the specified voltage.**

			<ul style="list-style-type: none"> <li>● If you are going to use an AC power cord, make sure that its has the correct plug shape and conforms to the specified power voltage.</li> <li>● Failure to do so may result in fire.</li> </ul>
--	--	--	--

**Do not insert or disconnect the power cord plug with wet hands.**

Doing so may cause electric shock.

**The chair must be used properly (it must be used only when playing the product).**

- Do not play with it or stand on it.
- Only one person is allowed to sit on it.
- Do not sit on it when opening the lid.

Doing so may cause the chair to fall over or your fingers to be trapped, resulting in injury.

**When using the headphones, do not listen for long periods of time at high volume levels.**

Doing so may result in hearing problems.

Do not lean against the keyboard.



Doing so may cause the product to fall over, resulting in injury.

Do not disassemble, repair or modify the product.



Doing so may result in product breakdown, electric shock or short-circuit.

When disconnecting the AC power cord's plug, always hold the plug and pull it to remove it.



● Pulling the AC power cord itself may damage the cord, causing a fire, electric shock or short-circuit.

The product is not completely disconnected from the power supply even when the power switch is turned off. If the product will not be used for a long time, unplug the AC power cord from the AC outlet.



● Failure to do so may cause fire in case of lightning.  
● Failure to do so may over-heat the product, resulting in fire.

This product may be equipped with a polarized line plug (one blade wider than the other). This is a safety feature. If you are unable to insert the plug into the outlet, contact an electrician to replace your obsolete outlet. Do not defeat the safety purpose of the plug.

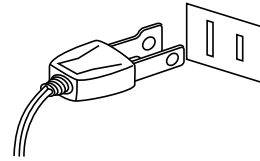

## CAUTION

Indicates a potential hazard that could result in injury or damage to the product or other

Do not use the product in the following areas.

- Areas, such as those near windows, where the product is exposed to direct sunlight
- Extremely hot areas, such as near a heater
- Extremely cold areas, such as outside
- Extremely humid areas
- Areas where a large amount of sand or dust is present
- Areas where the product is exposed to excessive vibrations

Using the product in such areas may result in product breakdown.

When you close the keyboard cover, close it gently.



Closing it roughly may trap your fingers, resulting in injury.

Before connecting cords, make sure that the power to this product and other devices is turned OFF.



Failure to do so may cause breakdown of this product and other devices.

Take care not to allow any foreign matter to enter the product.

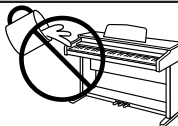

Entry of water, needles or hair pins may result in breakdown or short-circuit. The product shall not be exposed to dripping or splashing. No objects filled with liquids, such as vases, shall be placed on the product.

Do not drag the product on the floor. Take care not to drop the product.

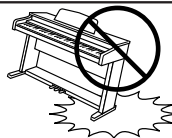

Please lift up the product when moving it. Please note that the product is heavy and must be carried by more than two persons. Dropping the product may result in breakdown.

Do not place the product near electrical appliances such as TVs and radios.

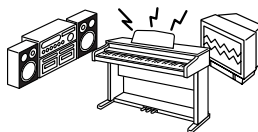

● Doing so may cause the product to generate noise.  
● If the product generates noise, move the product sufficiently away from the electrical appliance or connect it to another AC outlet.

When connecting the AC power cord and other cords, take care not to get them tangled.



Failure to do so may damage them, resulting in fire, electric shock or short-circuit.

**Do not wipe the product with benzene or thinner.**



- Doing so may result in discoloration or deformation of the product.
- When cleaning the product, put a soft cloth in lukewarm water, squeeze it well, then wipe the product.

**Do not stand on the product or exert excessive force.**



- Doing so may cause the product to become deformed or fall over, resulting in breakdown or injury.

**The product should be located so that its location or position does not interfere with its proper ventilation.**

**This product should be used only with the stand that is provided by the manufacturer.**

**The product should be serviced by qualified service personnel when:**

- The power supply cord or the plug has been damaged.
- Objects have fallen, or liquid has been spilled into the product.
- The product has been exposed to rain.
- The product does not appear to operate normally or exhibits a marked change in performance.
- The product has been dropped, or the enclosure damaged.

### **Notes on Repair**

Should an abnormality occur in the product, immediately turn the power OFF, disconnect the power cord plug, and then contact the shop from which the product was purchased.

### **CAUTION:**

To prevent electric shock, match wide blade of plug to wide slot, fully insert.

### **ATTENTION:**

Pour éviter les chocs électriques, introduire la lame la plus large de la fiche dans la borne correspondante de la prise et pousser jusqu'au fond.

### **Instruction for AC power cord (U.K.)**

Do not plug either terminal of the power cord to the ground of the AC outlet on the wall.

### **FCC Information**

This equipment has been tested and found to comply with the limits for a Class B digital device, pursuant to Part 15 of the FCC Rules. These limits are designed to provide reasonable protection against harmful interference in a residential installation. This equipment generates, uses and can radiate radio frequency energy and, if not installed and used in accordance with the instructions, may cause harmful interference to radio communications.

If this equipment does cause harmful interference to radio or television reception, which can be determined by turning the equipment off and on, the user is encouraged to try to correct the interference by one or more of the following measures:

- ¥ Reorient or relocate the receiving antenna.
- ¥ Increase the separation between the equipment and receiver.
- ¥ Connect the equipment into an outlet on a different electrical circuit from the receiver.
- ¥ Consult the dealer or an experienced radio/TV technician for help.

### **Canadian Radio Interference Regulations**

This instrument complies with the limits for a class B digital apparatus, pursuant to the Radio Interference Regulations, C.R.C., c. 1374.

# ASSEMBLING THE STAND

Be sure that all parts are included before starting to assemble your unit.

## PARTS PROVIDED

Side Panel (A)	2 pcs.	M6 x 25	ø4 x 16	ø4 x 25	Adjuster	Cord Clamp
Back Board (B)	1 pc.					
Pedal Board (C)	1 pc.					
Screw (D) (M6 x 25)	4 pcs.					
Screw (E) (ø4 x 16)	6 pcs.					
Screw (F) (ø4 x 25)	2 pcs.					
Adjuster (G)	1 pc.					
Cord Clamp (H)	1 pc.					
Headphone Hook Set	1 set.					

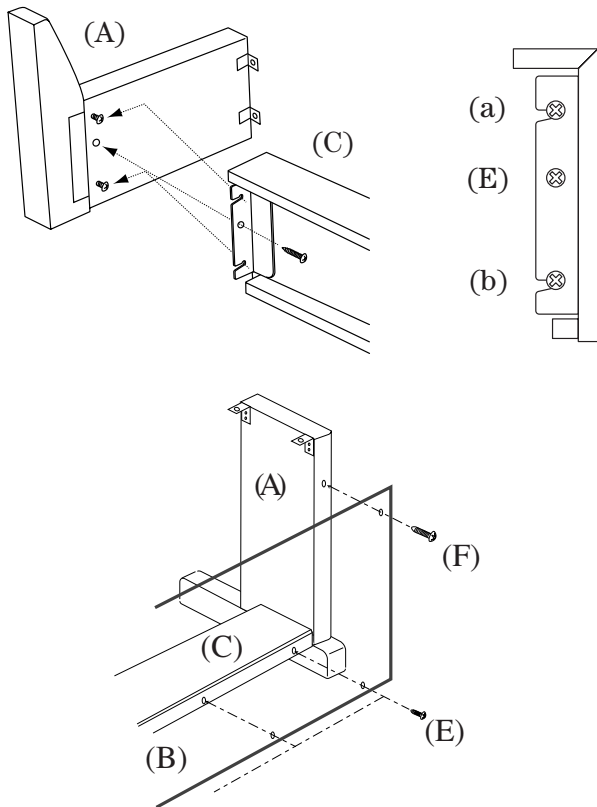

1. Insert the Adjuster (G) on the Pedal Unit.

2. Untie the pedal cable on the bottom of the Pedal Board (C).

3. Slide the metal bracket located at the end of Pedal Board (C) on to screws (a) and (b) of Side Panel (A). Install tighten screw (E) then tighten screws (a) and (b). Repeat this procedure on the other end of the Pedal Board, then raise the completed stand assembly.

4. Fasten Side Panel (A) and Back Panel (B) with two screws (F). Then fix Back Panel (B) to Pedal Board (C) with four screws (D).

### CAUTION:

To prevent personal injury, do not handle the main unit from the ends.

5. The next step requires one person on each end of the main unit. Grasp the unit with both hands, one under the front, the other under the rear (remember, not the end) and carefully center the main unit on top of the stand so that the hook brackets located on the bottom rear of the main unit are inside the stand side panels (A) and approximately one-third of the rear, top edge of the side panels are exposed. (See the illustration to the right)

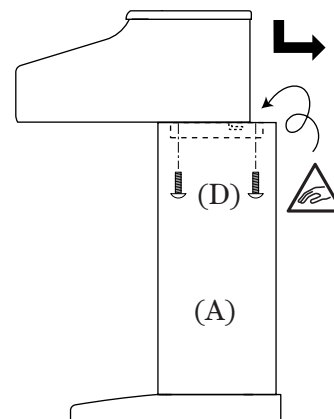

6. Maintaining a firm grasp under the front of the main, unit slide it toward the rear of the stand until the hook brackets engage the brackets at the rear top of the side panels (A). This hook arrangement is design to prevent the main unit from tilting forward while the screws are installed. Keep one hand under the front of the main unit, push down on the front to be certain that hooks are properly engaged.

7. Fasten the main unit and the stand with four screws (D).

**CAUTION:**

**Be sure to secure the main unit to the stand with the screws. If you fail to do so, the unit could fall from the stand causing damage or personal injury.**

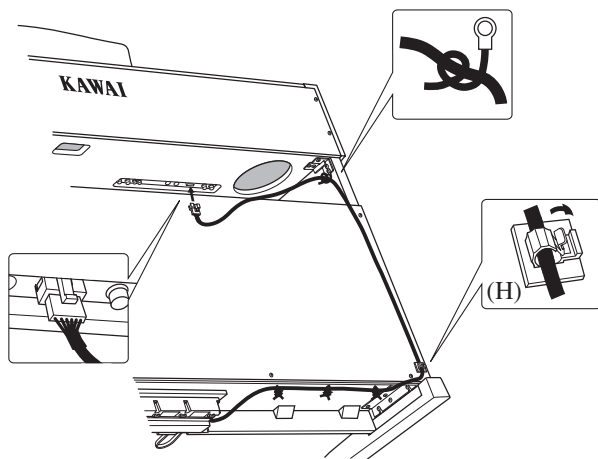

Bottom View

8. Insert the pedal connection cord that comes from Pedal Board (C) into the piano's pedal jack and fasten with cord clamps.

9. Turn the adjuster (installed on the bottom of the Pedal Unit) down until it makes firm contact with the floor. If the floor is carpeted, place a spiked furniture cup under the adjuster so that it makes firm contact with the carpet backing. Press any pedal with your foot. If the pedal rail flexes, lower the adjuster until flexing is minimized.

**CAUTION:**

**Before moving your piano, turn the adjuster up so that it clears the floor.**

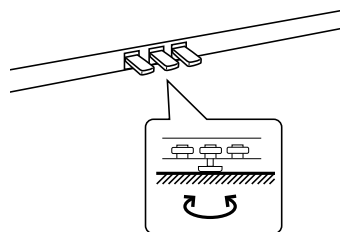

**Attaching The Headphone Hook (Option)**

Fix the headphone hook to the bottom of the piano with two screws packed in the same plastic bag.

# PART NAMES

---

## MASTER VOLUME SLIDER (A)

Move the volume slider to the right to increase the instrument's volume. Move the slider to the left to decrease the volume.

## CONCERT MAGIC BUTTON (B)

This button is used to listen to a Concert Magic song.

## DEMO BUTTON (C)

To listen to the demos, simply press this button and the demos will start.

## STYLE BUTTONS (D)

These buttons are used to select different styles to accompany your playing.

## 1-2 PLAY BUTTON (E)

This button is used to automatically choose an appropriate sound and setup for the selected style.

## METRONOME BUTTONS (F)

This button is used to start/stop the metronome.

## ACC BUTTON (G)

This button is used to turn the auto accompaniment style function on/off.

## SYNC BUTTON (H)

When active, the accompaniment style will start as soon as you play a note or chord on the keyboard.

## START/STOP BUTTON (I)

This button is used to start and stop the accompaniment style.

## INTRO/ENDING BUTTON (J)

This button is used to play an intro section that leads into the style. If you press this button while the style is playing an ending section will be played before stopping.

## FILL IN BUTTON (K)

This button is used to play a short fill in section that embellishes the style and leads to the next section.

## FRONT PANEL

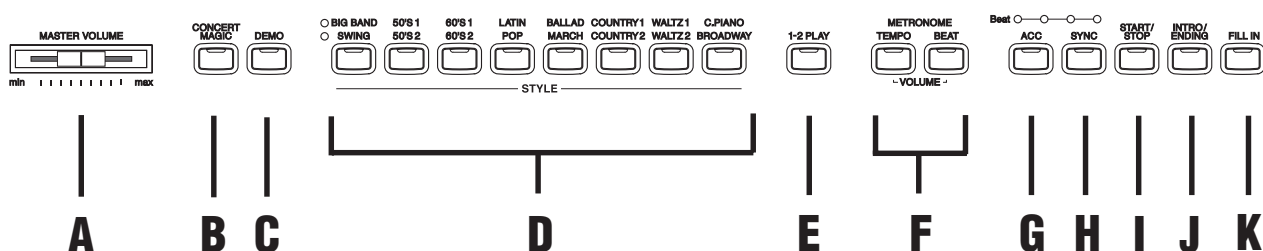



## VALUE BUTTONS (L)

This buttons are used to adjust tempo, scroll through different selections, and adjust data values on the LED display.

## EFFECTS BUTTON (M)

This button turns the Effect on/off.

## REVERB BUTTON (N)

This button turns the Reverb on/off.

## BALANCE SLIDER (O)

This slider adjusts the volume balance of the two sounds used in Dual mode. Also adjusts the volume of the accompaniment style.

## SOUND BUTTONS (P)

These buttons are used to select the desired sound.

## RECORDER BUTTONS (Q)

The PLAY/STOP button is used to play back and stop a recorded song.

The REC button is used to start recording a song.

You can record and play back up to three songs.

## FUNCTION BUTTONS (R)

These buttons are used to select a touch type, transpose the keyboard, and control other features (including MIDI functions).

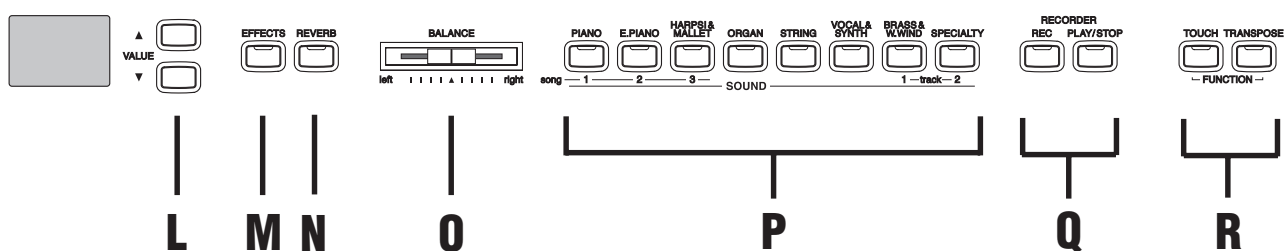

### **POWER BUTTON (a)**

This button turns the instrument on and off. Be sure to turn off the instrument when you are finished playing.



|  
**a**

### **SOFT PEDAL (b)**

Depressing this pedal softens the sound and also reduces its volume.

### **SOSTENUTO PEDAL (c)**

Depressing this pedal after playing the keyboard and before releasing the keys sustains the sound of only the keys just played.

### **SUSTAIN PEDAL (d)**

Depressing this pedal sustains the sound even after you remove your hands from the keyboard.

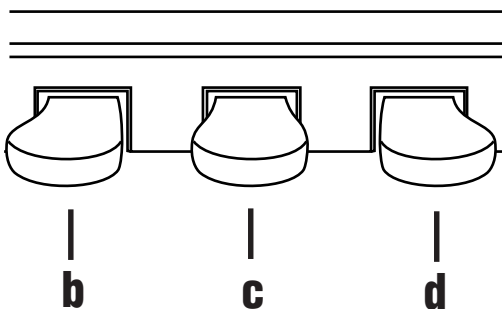

### **LINE OUT JACKS (e)**

These jacks are used to connect an external amplifier and speakers, or a cassette recorder to the CP piano.

### **LINE IN JACKS (f)**

These jacks are used to connect stereo outputs from other audio equipment or electronic instruments to the CP piano's speakers.

### **MIDI JACKS (g)**

These jacks are used to connect the CP piano with external MIDI devices.

### **PEDAL JACK (h)**

Connect the pedal cord from the pedal board to this jack.

### **HEADPHONES JACKS (i)**

These jacks are used to connect up to two headphones to the CP67.

### **BOTTOM**

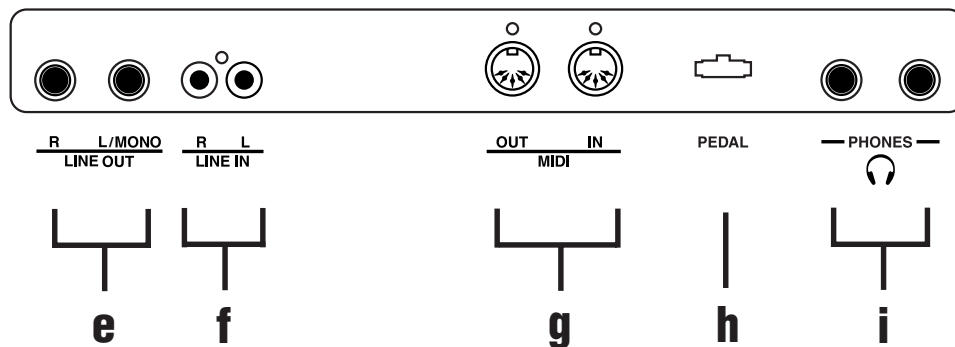

# GETTING STARTED

---

## 1. BASIC OPERATIONS



### (1) Turn on the power.

You will find the POWER SWITCH at the right end of the front panel. Press this button to turn on the power. Pressing it again will turn off the power.

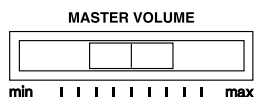

### (2) Adjust the volume.

Play a note on the keyboard and adjust the volume (Moving the slider to the right raises the volume while moving to the left lowers it.)

### (3) Select a sound.

Press the SOUND SELECT button under the name of the instrument you would like to listen to. When the button is pressed, the LED indicator will be turned on to indicate that this sound is selected. The SOUND SELECT buttons are assigned with three preset sounds to select. **To select the other sounds, press the button repeatedly.** When a SOUND SELECT button is pressed, the variation number is briefly shown in the display. Pressing the same SOUND SELECT button again will select the next variation sound assigned to the SOUND SELECT button.

You can also select any preset sounds by using the VALUE buttons while the variation number is shown on the LED display.

### (4) Play.

Experiment by playing the different sounds.

### (5) Dual

Another feature of the CP piano is the ability to layer two preset sounds together to create a more complex sound. For example, piano layered with strings, e. piano with brass sound, and so on.



To layer two sounds, **select the first sound and then, while holding down that SOUND SELECT button, select the second sound by pressing another SOUND SELECT button.** The LED indicators for each will be turned on to indicate the two sounds you have chosen. The display briefly shows the combination of the selected sound variation numbers.

You can adjust the volume balance between the two sounds. **Use the Balance slider to adjust the balance.** Move the slider to the right to increase the volume of the rightmost preset sound and decrease the volume of the leftmost preset sound. The balance changes in the opposite way when the slider is moved to the left.

## ABOUT POLYPHONY

The CP piano is capable of playing up to 96 notes simultaneously (96-note polyphony). When playing in dual mode or when playing the stereo piano sound, the polyphony will be reduced by half since the piano has to produce two sounds for each note.

## (6) Reverb



-REVERB adds reverberation to the sound simulating the acoustic environment of a recital room or concert hall.

There are six types of reverb in the CP67. They are Small Room, Medium Room, Large Room, Medium Hall, Large Hall and Plate.

**To add reverb to the sound, press the REVERB button. The LED indicator will be turned on. If you hold down the REVERB button for few seconds, the current setting will be shown in the display.**

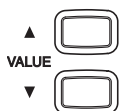

**To change the reverb type, use the VALUE buttons while holding down the REVERB button.**

The reverb is “ON” when the LED of the REVERB button is lit.

**Pressing the REVERB button once again turns the reverb “OFF”.**

When the power is turned on, the reverb function is automatically activated.



Small Room Medium Room Large Room Medium Hall Large Hall Plate

## (7) Effects



-Adding an effect to the sound enhances tonal quality and improves acoustical realism.

There are twelve types of effect in the CP67. They are Chorus 1, Chorus 2, Chorus 3, Chorus 4, FB Chorus, Tremolo, Rotary 1, Rotary 2, Flanger, Delay 1, Delay 2 and Delay 3.

**To add an effect to the sound, press the EFFECTS button. The LED indicator will be turned on and the LED display will show you which effect is currently selected.**

**To change the effect type, use the VALUE buttons while holding down the EFFECTS button.**

**Pressing the EFFECTS button once again turns the effect “OFF”.**



Chorus 4 FB Chorus Tremolo Rotary 2 Flanger Delay 3

## 2. STYLE

### (1) Select a style.

Press one of the **STYLE** buttons. The LED of the selected **STYLE** button will light to indicate which style is currently in being used. Pressing the active **STYLE** button again will switch to the alternative style of the **STYLE** button.



### (2) Start the style.

Pressing the **START/STOP** button will start the style. Pressing it again will stop the style.



Pressing the **INTRO/ENDING** button will start the style with an intro section. Pressing it again will stop the style with an ending section.



Pressing the **FILL IN** button while the style is running will play a short fill in section which embellishes the style and leads to the next variation section.



When the **SYNC** button is pressed, the style will not start until you play a note or chord on the keyboard.



### (3) Adjust the Tempo.

You can adjust the tempo by using the **VALUE** buttons. The tempo is shown in the LED display when the style is running. If the tempo is not shown in the LED display, touching the **VALUE** buttons will activate the LED display to show the tempo.

### (4) Turn on the accompaniment.

When the **ACC** button is pressed, the CP piano will play a complete accompaniment style. In addition, the keyboard will be split into two sections-upper and lower keyboard. When the **ACC** button is turned OFF only the rhythm accompaniment will be played. With the **ACC** button ON, when you play a chord in the lower keyboard the accompaniment style will automatically follow the chords you play. The accompaniment system is capable of following single finger as well as more complex chord voicings. If you want to change the volume for the style, **use the Balance slider while holding down the ACC button**. The LED display shows you the volume level for the style from 0 (soft) to 127 (loud). If you want to change the split point for the lower keyboard, **press a key on the keyboard while holding down the ACC button**. The pressed key will be the lowest note for the upper keyboard.





### (5) 1-2 Play mode

When the 1-2 PLAY button is activated, the CP piano will automatically choose an appropriate sound setup and tempo for the selected style.

You can adjust the volume of the accompaniment style by using **Balance** slider.

## 3. TRANSPOSE



The transpose function lets you raise or lower the piano's key in half steps. This is especially useful when you have learned a song in one key and have to play it in another key. The transpose feature allows you to play the song in the original key, but hear it in another key.

Value: 0



**To transpose the keyboard, press and hold the TRANSPOSE button.** The LED display shows you the current value. The value is always set to "0" when the power is turned on.

Value: -5

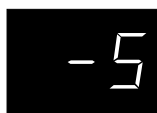

**While still holding the TRANSPOSE button, use the VALUE buttons or the keyboard from C2 to C4 to specify the transposition amount.** The LED display shows you a number telling you how many half steps up or down you have transposed the piano. -5, for example, represents a transposition that is 5 half steps lower. "0" indicates no transposition.

The piano can be transposed up to 12 half steps higher or 12 half steps lower.

**Pressing TRANSPOSE button again turns the transpose function off.**

The TRANSPOSE function remembers the current setting as long as the power is on.

## 4. TOUCH RESPONSE



When playing a piano, the volume of the sound produced increases in direct relation to how hard a key is struck. The CP piano offers the realistic feel of an acoustic piano for practicing music. The touch response function simulates the standard touch of an acoustic piano when the LED of the TOUCH button is off. When the LED of the TOUCH button is lit, you can select other touch types as follows.



LIGHT 1

**Light 1 / 2 (Lt):**

For those still developing finger strength, such as a child, a louder sound is produced even when the piano is played with a soft touch. Light 2 is lighter than Light 1.



HEAVY 2



OFF

**Heavy 1 / 2 (HE):** Perfect for those with strong fingers or for practicing with a hard touch. Heavy 2 is heavier than Heavy 1.

**Off (OFF):** For tone colors like organ or harpsichord, and for playing some contemporary music with the piano sound, a constant loud sound is produced regardless of your force on the keys.

**To change the touch type, press and hold the TOUCH button.** The LED display shows you the current touch type. **While holding the TOUCH button, use the VALUE buttons to change the touch type.**

**Press the TOUCH button again to get back to the standard touch setting.**

Once the power is turned off, the touch type will be reset to the standard setting.

## 5. DEMONSTRATION SONG



The CP piano has 3 built in demonstration songs for your listening enjoyment.

**Press the DEMO button and the first demo song will start.** The LED display shows the demo song number. When the first demo song is finished, the CP piano will play all the other demo songs one at a time in order.

If you would like to listen to a particular demo song, **use the VALUE buttons to select your desired song.**

**To stop the demo, press the DEMO button again at any time.**

## 6. METRONOME



Rhythm is one of the most important elements when learning music. It is important to practice playing the piano in the right tempo and with a steady rhythm. The CP piano's metronome is a tool that helps you to achieve this by providing a steady beat for you play along with.

### **Starting the Metronome**

**Press the TEMPO button.** You will see the LED display turns on and hear the metronome begin counting with a steady beat. The display shows the tempo in beats per minute

**To change the tempo, use the VALUE buttons** to increase or decrease the tempo within the range of 30-250 beats per minute. (60-500 BPM with 6/8).

**To stop the metronome, press the TEMPO button again.**



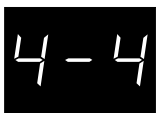

### Changing the time signature

You probably noticed that there are two types of clicks and the louder one comes every fourth beat. The metronome is capable of giving you a down beat to indicate the beginning of the measure. You are now hearing a 4-beat or 4/4 time signature.

You can select different a time signature if you want to out of the seven available with the CP piano—1/4, 2/4, 3/4, 4/4, 5/4, and 6/8.



To change the time signature, use the BEAT button.

**Press the BEAT button.** You will see the LED indicator turn on and hear the metronome begin counting. The display shows the time signature.

**Use the VALUE buttons to select your desired time signature.**

You will see the time signature currently selected in the display.

**To stop the metronome, press the BEAT button again.**

You can use either the TEMPO or BEAT button to turn the metronome on and off. Choose the appropriate button depending on whether you're adjusting the tempo or changing the time signature.

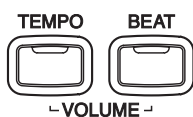

### Adjusting the Metronome Volume

The volume level of metronome can be adjusted to any level you like independent of the main volume.

**Press the TEMPO and BEAT buttons simultaneously.** The display shows the volume level of the metronome in numbers from 1 (soft) to 10 (loud). The factory preset is 5.

**Use the VALUE buttons to change value.**

# DIGITAL RECORDING FUNCTIONS

---

## 1. EASY RECORDING



Press the **REC** button. The CP piano is now ready to record. **To cancel the recording, press the REC button again.**



**Begin playing some music on the piano.** The CP piano will automatically start recording with the first note you play. You can also start recording by pressing the **PLAY/STOP** button.

**Press the PLAY/STOP button when you have finished recording.**

### NOTE:

Starting another recording will delete the song you previously recorded.

## 2. PLAYING BACK A SONG

Press the **PLAY/STOP** button. The song will be played back using the same tone (sound) with which it was recorded.

**Press the PLAY/STOP button once again to stop the playback.** If you do not press the **PLAY/STOP** button, playback will automatically stop when the song is finished.

**You can adjust the tempo of playback by using the VALUE buttons.**

## 3. ADVANCED RECORDING/PLAYBACK FUNCTIONS

### RECORDING MORE SONGS

The CP piano can record and store a maximum of 3 songs. Please follow the steps below to save your songs:

**While holding down the REC button, press the Song 2 button.**

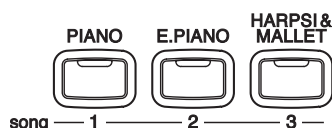

The LED will blink to show the current song number (while the REC button is held down). The piano is now ready to record (Song 2). **To cancel without recording, press the REC button again.**

**Play the piano.** Playing the piano will automatically start the recording. You can also start recording by pressing the **PLAY/STOP** button.

**Press the PLAY/STOP button after you have finished recording.**

**Holding down the PLAY/STOP button, press the SONG 2 button.**

**Releasing both buttons will play Song No.2.** Playback will automatically stop when the song is finished. **You can adjust the tempo of playback by using the VALUE buttons.**

### **RECORDING/PLAYING BACK THE LEFT AND RIGHT HAND PARTS SEPARATELY**

The CP piano can record the parts played by the left or right hand and play back these parts separately or simultaneously. This function can be enjoyed in different ways. For example, you can practice the right-hand part of the song while playing back the recorded left-hand part, or record the melody part of the song while playing back the previously recorded accompaniment.

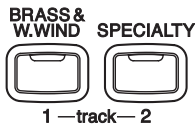

**While holding down the REC button, press the SONG 3 button to select Song No.3.** Track 1 of Song No.3 will be selected and the CP piano is now ready to record. **To cancel without recording, press the REC button again.**

**Play the piano with your left hand.** Playing the piano will automatically start the recording. You can also start recording by pressing the PLAY/STOP button.

**Press the PLAY/STOP button after you have finished recording.**

**Now, to play back the left-hand part, press the PLAY/STOP button.** The left-hand part you have recorded (Track 1 of Song No.3) will be played back. You can practice the right-hand part along with the recorded part. **You can adjust the tempo of playback by using the VALUE buttons.**

Let's record the right-hand part while listening to the left-hand part.

**While holding down the REC button, press the TRACK 2 button.** The Track 1 LED will light and the Track 2 LED will flash to indicate that the piano is now ready to record Track 2. **To cancel without recording, press the REC switch again.**

Now play the right-hand part. **Pressing any key will start play back of the recorded left-hand part (Track 1) while you play (and record) the right-hand part.** You can also start recording by pressing the PLAY/STOP button. **After pressing the PLAY/STOP button the left-hand part will begin playing back, you can then begin playing (recording) the right hand part from any point in the song you like.**

**Press the PLAY/STOP button after you have finished recording.**

**NOTE:**

If you play with the style (rhythm and accompaniment), it is also recorded but only on track 1.

**PLAYING BACK THE LEFT- AND RIGHT-HAND PARTS SEPARATELY**

After you have recorded the left- and right-hand parts (Track 1 and Track 2) separately, it is possible to play back the two parts by themselves or together. The following example shows how to play back only Track 2.

**Select and press one of the SONG buttons (Song 1, Song 2 or Song 3) while pressing the PLAY/STOP button.**

**While holding down the PLAY/STOP button, press the TRACK 1 button.**

The TRACK 1 button LED will be turned “off”. If you need to turn Track 1 back “on”, press the TRACK 1 button once again.

**Releasing both buttons will play back only Track 2. You can adjust the tempo of playback by using the VALUE buttons.**

## **4. DELETING A SONG/TRACK**

This function allows you to delete songs that were not recorded correctly or songs that you do not want to listen to any more.

**Simultaneously hold down the PLAY/STOP and REC buttons.**

The LEDs will light to show you where songs have been recorded.

**While holding down both the PLAY/STOP and REC buttons, press the SONG button that corresponds to the song you want to delete.**

**While still holding down both the PLAY/STOP and REC buttons, press the TRACK button that you want to delete and turn the LED of that TRACK button off.**

**To delete more than one song, repeat the above procedure.**

**NOTE:**

– The total memory capacity of the recorder is approximately 7,000 notes. When the recorder reaches its maximum capacity, the CP piano will stop recording at this point. Any data recorded before the interruption will be retained.

– **To delete all recorded songs (reset), first turn the power off and then turn it back on again while holding down both the PLAY/STOP and REC buttons.**

# CONCERT MAGIC

---

The great German composer Johann Sebastian Bach once said, “Playing the keyboard is simple. Just strike right keys at the right time.” Many people wish it were that simple. The reality is very different of course. However, there is a way to make playing the keyboard very simple. You don’t even have to strike right keys thanks to Concert Magic.

With Concert Magic, absolutely anyone can sit at the CP piano and make real music... even if you’ve never taken a piano lesson in your life.

To enjoy performing by yourself, you have only to select your favorite piece from 40 preprogrammed songs and tap any of the 88 keys with a steady rhythm and tempo. Concert Magic will provide the correct melody and accompaniment notes, regardless of which keys you press. Anybody, young or old, can enjoy Concert Magic from the moment they sit down at the CP piano.

Now let’s see how Concert Magic works.

## 1. SELECTING A SONG

The 40 Concert Magic songs are assigned to each of the 40 white keys, classified in six groups by song category such as Children’s Songs, American Classics, Christmas Songs.

All of the song titles are listed on page 33.



**To select a song, press the key to which your desired song is assigned while holding down the CONCERT MAGIC button.**

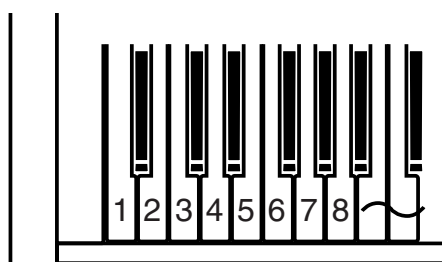

## 2. LISTENING TO THE SONG

If you have selected a song you are familiar with, you may want to play by yourself right away. However you may want to listen to the song first before playing it.

**To listen, press the PLAY/STOP button.** The CP piano will start playing back the selected song. When the demo song is finished, press the START/STOP button again to stop. Otherwise the CP piano will play all the other Concert Magic songs one at a time in order.

If you want to listen to a different song, repeat the same procedure to select a song.

### **3.PERFORMING A SONG**

Now you're ready to play yourself.

**Tap out the rhythm of the selected song on any one of the 88 black or white keys on your piano keyboard.** As you tap harder, the notes will get louder; as you tap softer, the notes will get quieter. As you tap faster, the notes speed up; as you tap slower, they will slow down correspondingly, just like regular piano playing.

Isn't it fun? You can sound like you've been playing for years just by pressing one key with one finger.

Concert Magic is a perfect method for small children to learn music, especially to develop a sense of rhythm. For older people who may think it is too late to learn the keyboard, Concert Magic is a good first step for them to begin with. With Concert Magic, your CP piano can be enjoyed by anyone in the family, even those who have never touched a musical instrument in their life.

### **4.CONCERT MAGIC SONG ARRANGEMENT TYPES**

After playing for a while with Concert Magic you may think that it's too easy and there is very little to learn.

While it is true that some of the songs are very easy to play, even for beginners, there are also some which will challenge you and require some practice to play beautifully. Each of the 40 Concert Magic songs falls into one of three different categories depending on the skill level required to perform them.

#### **Easy Beat**

These are the easiest songs to play. To perform them, simply tap out a constant steady beat on any key on your piano keyboard.

Look at the following example, "Für Elise". Press the key with a steady sixteenth note rhythm.

Key on                    x x x x x x x x    x x x x x x x x    x x x x x x

The image shows musical notation for the beginning of 'Für Elise' in 3/8 time. Above the staff, there are two groups of rhythmic notation: 'x x x x x x x x' and 'x x x x x x x x', each followed by a space and then 'x x x x x x'. The notation itself consists of two staves. The top staff is in treble clef and shows a sequence of notes: a quarter rest, followed by a quarter note (D4), an eighth note (E4), a sixteenth note (F4), a quarter note (G4), an eighth note (A4), a sixteenth note (B4), a quarter note (C5), an eighth note (B4), a sixteenth note (A4), a quarter note (G4), an eighth note (F4), a sixteenth note (E4), a quarter note (D4), an eighth note (C4), and a sixteenth note (B3). The bottom staff is in bass clef and shows a sequence of notes: a quarter rest, followed by a quarter note (D3), an eighth note (C3), a sixteenth note (B2), a quarter note (A2), an eighth note (G2), a sixteenth note (F2), a quarter note (E2), an eighth note (D2), a sixteenth note (C2), a quarter note (B1), an eighth note (A1), and a sixteenth note (G1).

### Melody Play

These songs are also quite easy to play, especially if they are familiar to you. To perform them, tap out the rhythm of the melody on any one of the keys on your piano keyboard. Singing along as you tap the rhythm can be helpful.

Key on      x x x x    x x x      x x x x    x x x



Play “Twinkle, Twinkle, Little Star” for example. Follow the melody’s rhythm as shown.

When performing fast songs with Concert Magic, it is sometimes easier to tap two different keys with two fingers alternating. This allows you to play twice as fast as you can using only one finger on one key.

### Skillful

These songs range in difficulty from moderately difficult to difficult. To perform them, tap out the rhythm of both the melody and the accompaniment notes on any of the keys on your piano keyboard, like “Waltz of The Flowers” shown below.

Key on      x x x    x x    x x x    x x    x x x

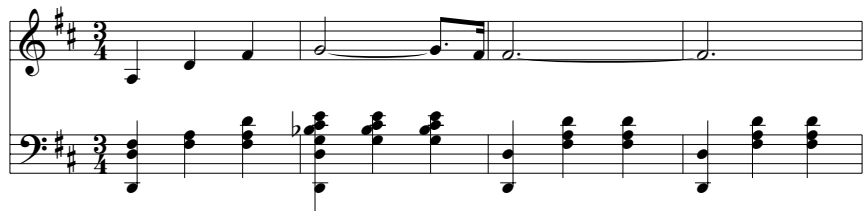

It may take some practice to get them just right. A good way to learn these songs is to listen to them first, and then try to tap out the rhythms that you hear.

In the song list on page 33, the arrangement type is marked next to each song title as “EB” for Easy Beat, “MP” for Melody Play and “SK” for Skillful.

## **5. Concert Magic Song Demo**

There are three ways to listen to the Concert Magic songs in the DEMO mode.

### **All Play**

**Press the CONCERT MAGIC button and then press the PLAY/STOP button without selecting a song.** The CP piano will play back all of the Concert Magic songs in order.

### **Random Play**

**Press the CONCERT MAGIC button and then press the DEMO button.** The CP piano will play back all of the Concert Magic songs in random order.

### **Category Play**

**Press the piano key to which the desired song is assigned while holding down the DEMO buttons.** The CP piano will play back the selected song and, then play the rest of the songs in the same song category one after another.

To stop the demo, **press the PLAY/STOP button.**



# FUNCTION MODE

---

The Function Mode gives you access to many other useful features on your CP piano. **To enter the Function Mode, press the TOUCH and TRANSPOSE buttons at the same time.** The LEDs for both buttons will flash. Press one of the following sound buttons to choose a function to edit. **To exit the Function Mode, press either the TOUCH button or TRANSPOSE button.**

The following functions can be selected in the Function Mode:

- Tuning (PIANO button)
- Temperament (E. PIANO button)
- MIDI Channel (HARPSI & MALLETT button)
- Transmit Program Change On/Off (ORGAN button)
- Local Control On/Off (STRING button)
- Channel Mute (VOCAL & SYNTH button)
- Program Change Number (BRASS & W.WIND button)

## 1. TUNING

This function allows you to adjust the piano's pitch. You may need to adjust the tuning when you play with other instruments or recordings.

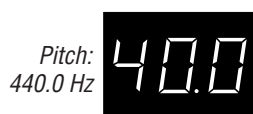

**Press the PIANO button while in the function mode. The LED display shows you a number that represents the pitch for “A” in Hz (Hertz). The range of adjustment is from 427.0 to 453.0 Hz (displayed as 27.0–53.0). The factory preset value is set to the modern standard A = 440.0 Hz (displayed as 40.0).**

Use the VALUE buttons to raise or lower the pitch.

## 2. TEMPERAMENT

The CP piano offers not only equal temperament (the modern standard) but also immediate access to temperaments popular during the Renaissance and Baroque periods. It should be interesting and educational to try some of the different temperaments, although the equal temperament is dominant today.



**Press the E. PIANO button while in the function mode. The LED display shows you an abbreviation for the type of temperament currently selected. Use the VALUE buttons to select your desired temperament.**

After you have selected the desired temperament, you must select a key signature for the temperament. Limitless modulation of the key became available only after the invention of Equal temperament. When we use a temperament other than Equal temperament, we must carefully choose the key signature to play in.

Key in D 

Key in A# 

Equal(P.only) 

To select the key signature of the temperament, simply press one of the 88 piano keys. The LED display shows you the note name for the key you pressed and it will be chosen as the key of the temperament. For example, if the song you are going to play is written in D major, press any “D” key to set the temperament key.

### **BRIEF EXPLANATION OF TEMPERAMENTS**

#### **EQUAL TEMPERAMENT (PIANO ONLY)**

This is the default temperament. If a piano sound is selected the tuning is stretched like an acoustic piano (EQUAL TEMPERAMENT). If any other type of sound is selected the tuning will be EQUAL (FLAT). An explanation of EQUAL TEMPERAMENT and EQUAL TEMPERAMENT (FLAT) is provided later in this section.

#### **NOTE:**

If a piano sound is used in a layer with any other sound then both sounds will use the EQUAL TEMPERAMENT (Stretched) tuning.

Pure(Major) 

Pure(minor) 

#### **MERSENNE PURE TEMPERAMENT(Major)**

#### **MERSENNE PURE TEMPERAMENT(Minor)**

This temperament, which eliminates dissonances for thirds and fifths is still popular for choral music because of its perfect harmony.

You need to be aware what key you are playing in with this temperament. Any key modulation will result in dissonances. When you play music in a particular key, you need to match the key of the temperament as well. When playing in a major key select Pure (Major) and when playing in a minor key select Pure (minor).

Pythagorean 

#### **PYTHAGOREAN TEMPERAMENT**

This temperament, which uses mathematical ratios to eliminate dissonance for fifths, is very limited for use with chords, but it produces very characteristic melodic lines.

Meantone 

#### **MEANTONE TEMPERAMENT**

This temperament, which uses a mean between a major and minor whole tone to eliminate dissonance for thirds, was devised to eliminate the lack of consonances experienced with certain fifths for the Mersenne pure temperament. It produces chords that are more beautiful than those with the equal temperament.

Werckmeister 

Kirnberger 

### **WERCKMEISTER III TEMPERAMENT, KIRNBERGER III TEMPERAMENT**

These two temperaments are placed in between Meantone and Pythagorean. For music with few accidentals, this temperament produces the beautiful chords of the mean tone, but as accidentals increase, the temperament produces the characteristic melodies of the Pythagorean temperament. It is used primarily for classical music written in the Baroque era to revive the original characteristics.

Equal(Flat) 

### **EQUAL TEMPERAMENT(FLAT)**

This is “unstretched” equal temperament that divides the scale into twelve equal semitones. This produces the same chordal intervals in all twelve keys, and has the advantage of limitless modulation of the key. However the tonality of each key becomes less characteristic and no chord is in pure consonance.

Equal 

### **EQUAL TEMPERAMENT**

This is the most popular piano temperament. The hearing ability of a human is uneven and is not as accurate with high frequency and low frequency as it is with the middle range. This temperament’s tuning is stretched to compensate for this so the sound will be heard naturally to the ears. This “Stretched” equal temperament is a practical variation of the “unstretched” equal temperament which was invented on a mathematical basis.

## **3. MIDI CHANNEL**

This function determines on which channel the CP piano will exchange MIDI data with an external MIDI device or personal computer.

**Press the HARPSI & MALLETT button while in the function mode.** The LED display shows you the currently selected channel number. The default channel is 1.

Channel 15 

**Use the VALUE buttons to select your desired MIDI channel, 1-16.** When the power is first turned on, the CP piano always selects channel 1.

## 4. TRANSMIT PROGRAM CHANGE ON/OFF

This function determines whether or not the CP piano will transmit program change information when pressing the SOUND SELECT buttons. When this is turned on, pressing the SOUND SELECT buttons will send the program change numbers.



**Press the ORGAN button while in the function mode.**

The display alternatively shows “PGM” (= Program) and on/off status. The default is on.



**Use the VALUE buttons to toggle on and off.**

## 5. LOCAL CONTROL ON/OFF

This function determines whether the CP piano’s sound will be played from the piano’s keyboard (“On”) or only from an external MIDI instrument (“Off”).

Even with local control “Off” the piano’s keyboard will still transmit to an external MIDI instrument or personal computer.

**Press the STRING button while in the function mode.** The LED display shows you “On” or “Off”. The initial value is “On”.

Local Control  
ON



**Use the VALUE buttons to turn local control “On” and “Off”**

Local Control  
OFF



## 6. CHANNEL MUTE

This function determines which MIDI channels are activated to receive MIDI information. You can activate or deactivate each of the 16 channels individually.



**Press the VOCAL & SYNTH button while in the function mode.** The display alternatively shows “P 1” (=Play 1) and “On”. This means channel 1 is activated.



**Use the VALUE buttons to toggle on and off.**

To turn on and off the other channels, **use the 16 leftmost white keys to select a desired channel.** The display will show “P 1” through “P 16”. **Then use the VALUE buttons to turn them on and off.**

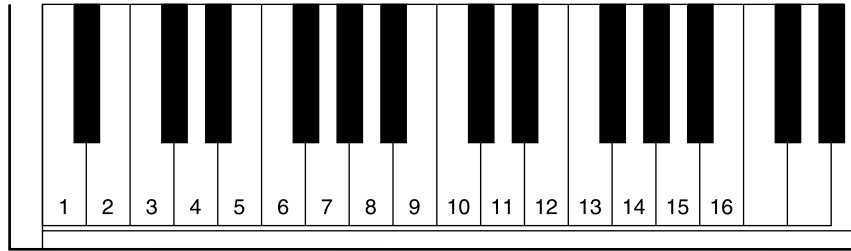

## **7. SENDING PROGRAM CHANGE NUMBERS**

This function allows the CP piano to transmit program change numbers beyond the 24 pre-defined numbers transmitted by the sound select buttons. Using this function, you can send any number from 1 to 128.



**Press the BRASS & W. WIND button while in the function mode.**



The display alternatively shows "PG#" (=Program#) and a program change number. **Use the VALUE buttons to change the number.**

**To send the program change number, press both VALUE buttons simultaneously.**

# MIDI

The term MIDI is an acronym for Musical Instrument Digital Interface, an international standard for connecting synthesizers, sequencers (digital recorders) and other electronic instruments so that they can exchange performance data.

The CP67 is equipped with two MIDI jacks for exchanging data: MIDI IN and MIDI OUT. Each uses a special cable with a DIN connector.

MIDI IN : For receiving note, program change and other data.

MIDI OUT : For sending note, program change and other data.

## MIDI EXAMPLES

### (1) Connection to another MIDI compatible keyboard or sound generator module

When connected as shown in the illustration, data on how the digital piano is played (which keys are struck) can be sent to another MIDI instrument. Plus, the sound from the CP67 can be layered over the sound of the other instrument.

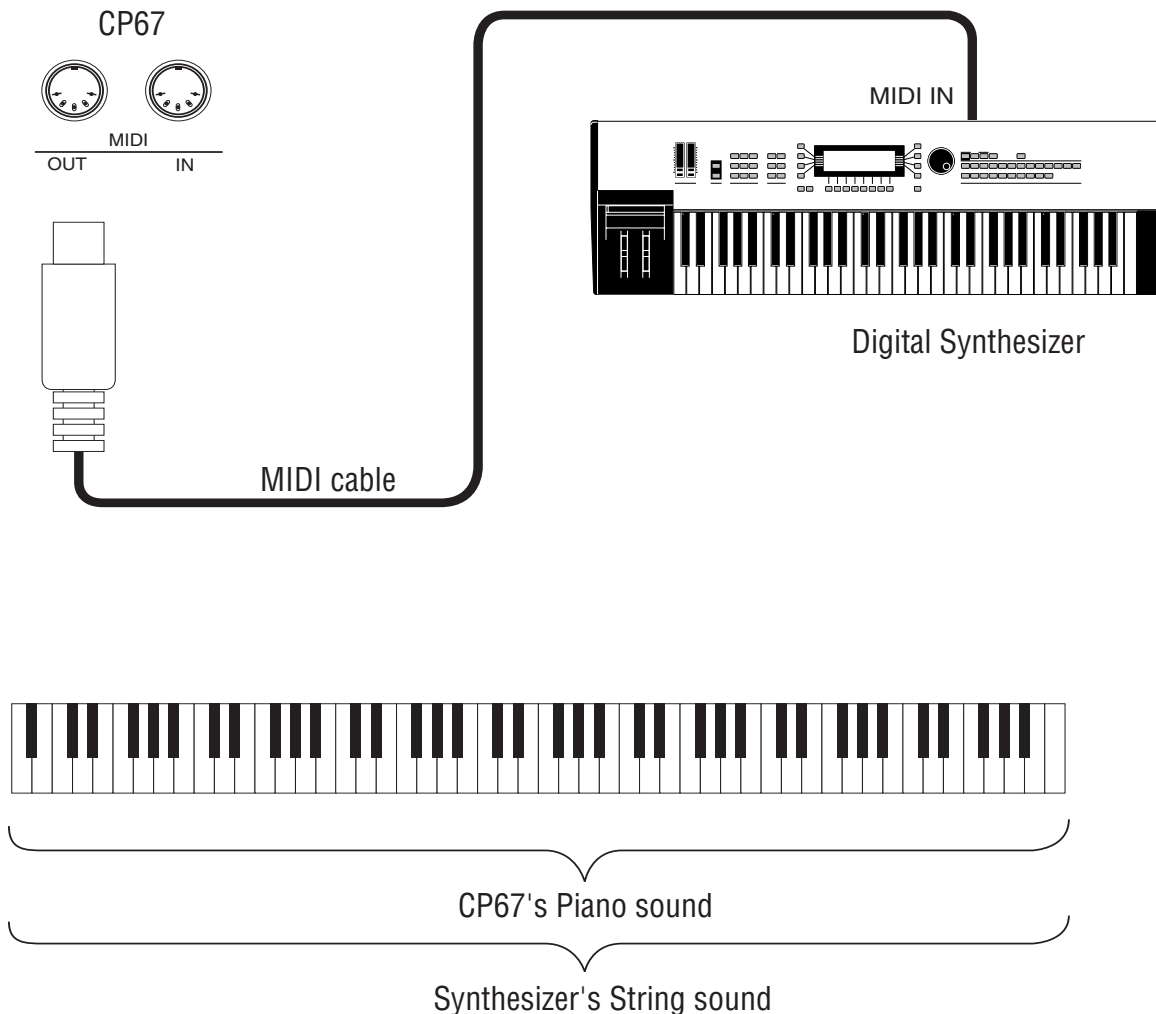

## (2) Connection to an external sequencer

When connected as shown in the illustration, you can record songs played on the CP67 with a sequencer, and use the CP67's tones controlled by the CP67's MULTI-TIMBRAL MODE function (which is ON at all times) to create a multi-layer MIDI recording.

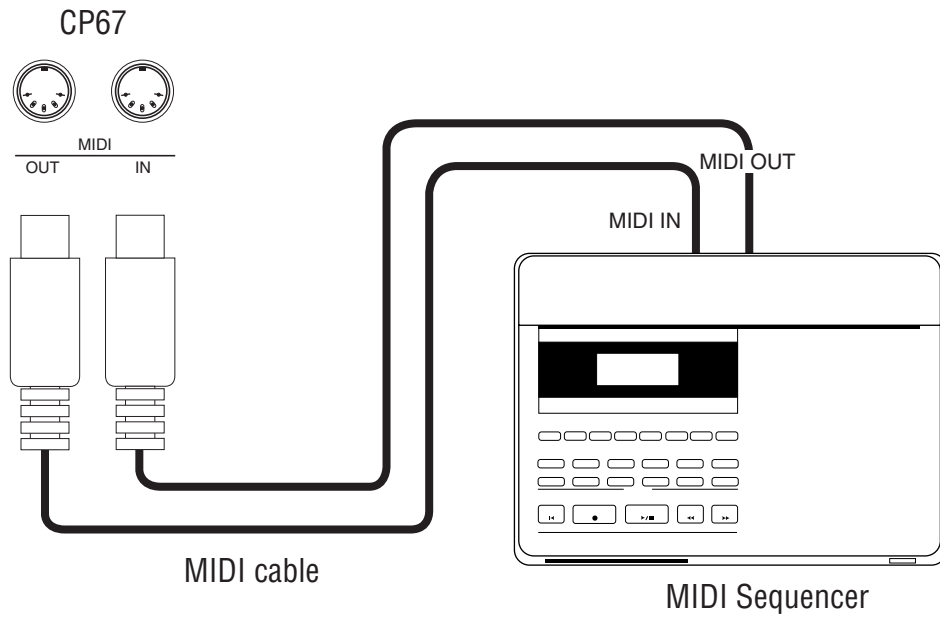

# LIST OF PRESET SOUND

---

<b>PIANO</b>	<b>E. PIANO</b>
1. Concert Grand	1. Classic E. Piano
2. Studio Grand	2. Modern E. Piano
3. Honky Tonk Piano	3. 60's E. Piano
<b>HARPSI &amp; MALLETT</b>	<b>ORGAN</b>
1. Vibes	1. Jazz Organ
2. Harpsichord	2. Drawbar Organ
3. Music Box	3. Church Organ
<b>STRING</b>	<b>VOCAL &amp; SYNTH</b>
1. String Ensemble	1. Choir Ahs
2. Slow Strings	2. New Age Pad
3. Violin	3. Atmosphere
<b>BRASS &amp; W.WIND</b>	<b>SPECIALTY</b>
1. Solo Trumpet	1. Nylon Acoustic Guitar
2. Flute	2. Accordion
3. Clarinet	3. Banjo

# STYLE LIST

---

BIG BAND

SWING

50'S 1

50'S 2

60'S 1

60'S 2

LATIN

POP

BALLAD

MARCH

COUNTRY 1

COUNTRY 2

WALTZ 1

WALTZ 2

C. PIANO (CLASSIC PIANO)

BROADWAY



# CONCERT MAGIC SONG LIST

---

Category	#	Song Title	Arrangement Type
Children's Songs	1	Twinkle, Twinkle, Little Star	MP
	2	I'm A Little Teapot	MP
	3	Mary Had A Little Lamb	MP
	4	London Bridge	MP
	5	Row, Row, Row Your Boat	MP
	6	Frère Jaques	MP
	7	Old MacDonald Had A Farm	MP
Christmas Songs	8	Hark The Herald Angels Sing	MP
	9	Jingle Bells	MP
	10	Deck The Halls	MP
	11	O Come All Ye Faithful	MP
	12	Joy To The World	MP
	13	Silent Night	MP
	14	We Wish You A Merry Christmas	MP
American Classics	15	Battle Hymn Of The Republic	MP
	16	Yankee Doodle	MP
	17	Danny Boy	EB
	18	Clementine	MP
	19	Auld Lang Syne	MP
	20	Oh Susanna	MP
	21	Camptown Races	MP
	22	When The Saints Go Marching In	EB
	23	The Entertainer	SK
Classical Selections	24	William Tell Overture	SK
	25	Andante (Haydn)	MP
	26	Für Elise	EB
	27	Clair De Lune	SK
	28	Skater's Waltz	SK
	29	Blue Danube Waltz	SK
	30	Gavotte (Gossec)	SK
	31	Waltz Of The Flowers	SK
Special Occations	32	Bridal Chorus	MP
	33	Wedding March	SK
	34	Pomp And Circumstance	SK
International Songs	35	When Irish Eyes Are Smiling	EB
	36	Chiapenacas	SK
	37	Santa Lucia	SK
	38	Funicli Funicla	SK
	39	La Marseillaise	MP
	40	My Wild Irish Rose	EB

---

# SPECIFICATIONS

---

Keyboard	88 Weighted Keys with Advanced Hammer Action IV
Touch Type	6 Types (Normal, Light 1/2, Heavy 1/2, Off)
Max Polyphony	96 Notes
Sounds	24 (from the panel), total 256 Sounds (GM2)
Effects	Chorus (1-4), FB Chorus, Flanger, Delay (1-3), Tremolo, Rotary (1-2) Reverb (Small Room, Medium Room, Large Room, Medium Hall, Large Hall, Plate)
Rhythm	16 rhythms with variations, Start/Stop, Intro/Ending, Sync, Fill In, ACC, 1-2 Play mode
Digital Recorder	3 Songs, 2 Tracks, 7,000 Notes
Other Functions	Metronome, Transpose, Tuning, MIDI Functions, 3 Demo Songs, 40 Concert Magic Songs
Pedals	3 (Soft, Sostenuto, Sustain)
Jacks	Headphones x 2, Pedal, MIDI (IN, OUT), LINE IN (L, R), LINE OUT (L/MONO, R)
Output Power	16 W x 2
Speakers	16 cm x 2
Power Consumption	50 W
Dimensions	139 x 47 x 84 (cm)
Weight	42.5 kg

Specifications are subject to change without notice.

# DEMO SONG LIST

---

1. Rhapsodie No.2 / Brahms
2. Original
3. Original

# MIDI IMPLEMENTATION CHART

KAWAI DIGITAL PIANO  
MODEL: CP67

Date: December 2005  
Version: 1.0

FUNCTION	TRANSMITTED	RECEIVED	REMARKS
Basic Channel (Default) (Changed)	1 1-16	1-16 x	
Mode (Default) (Message) (Altered)	3 x *****	3 3, 4	
Note Number (True Voice)	21-108 *****	0-127 0-127	
Velocity (Note ON) (Note OFF)	O: 9nH v=1-127 x: 8nH v=0	O x	
After Touch Key's Channel's	x x	x O	
Pitch Bend	x	O	
Control Change	O	O	Bank Select
0, 32	x	O	Modulation
1	x	O	Portament Time
5	x	O	Data Entry
6, 38	x	O	Volume
7	O	O	Panpot
10	O	O	Expression
11	x	O	Damper pedal
64	O (Right pedal)	O	Portament
65	x	O	Sostenuto pedal
66	O (Center pedal)	O	Soft pedal
67	O (Left pedal)	O	Hold 2
69	x	O	Resonance
71	x	O	Release
72	x	O	Attack
73	x	O	Cutoff
74	x	O	Decay
75	x	O	Vibrato Speed
76	x	O	Vibrato Depth
77	x	O	Vibrato Delay
78	x	O	Portament Control
84	x	O	Reverb Send Level
91	O	O	Chorus Send Level
93	O	O	NRPN LSB/MSB
98, 99	x	O	RPN LSB/MSB
100, 101	x	O	
Program Change	O	O	
True	*****	0-127	Program No. 1-128
System Exclusive	O	O	
Common (Song Position) (Song Select) (Tune)	x x x	x x x	
System: Real Time (Clock) (Commands)	O O	O O	
Others (All Sounds OFF) (Reset All Controllers) (All Notes OFF) (Active Sense) (Reset)	x x O O x	O O O O x	
Mode 1: OMNI ON, POLY Mode 3: OMNI OFF, POLY		Mode 2: OMNI ON, MONO Mode 4: OMNI OFF, MONO	

**KAWAI**