

**KAWAI  
DIGITAL PIANO**

**PN90**

**OWNER'S MANUAL**

Thank you for choosing this Kawai PN90 Digital Piano.  
 Your new PN90 is a high-quality instrument offering the very latest in leading-edge music technology.  
 This manual contains valuable information that will help you make full use of your PN90's many  
 capabilities. Please read it carefully and keep it handy for further reference.

## TABLE OF CONTENTS

	Page
Important Safety Instructions .....	3
Assembling The Stand .....	4
Part Names .....	6
Getting Started	
1. Basic Operations .....	8
2. Transpose .....	9
3. Touch Response .....	9
4. Demonstration Songs .....	10
Digital Recording Functions	
1. Easy Recording .....	11
2. Playing Back A Song .....	11
3. Advanced Recording/Playback Functions .....	12
4. Deleting A Song/Track .....	14
Programming Mode	
1. Selecting A Touch Type .....	15
2. Tuning .....	16
3. MIDI Channel Select .....	16
4. Turning Sending Program Number On And Off .....	17
5. Turning Multitimbre On And Off .....	17
6. Local Control On And Off .....	18
7. Reset .....	18
MIDI .....	19
SPECIFICATIONS .....	21
MIDI IMPLEMENTATION CHART .....	22

# IMPORTANT SAFETY INSTRUCTIONS

---

**WARNING – When using electric products, basic precautions should always be followed, including the following:**

1. Read all the instructions before using the product.
2. Do not use this product near water – for example, near a bathtub, in a wet basement, near a swimming pool, or the like.
3. This product, either alone or in combination with an amplifier and headphones or speakers, may be capable of producing sound levels that could cause permanent hearing loss. Do not operate for a long period of time at a high volume level. If you experience any hearing loss or ringing in the ears, you should consult a hearing specialist.
4. Place the AC power adaptor so that its location or position does not interfere with its proper ventilation.
5. The product should be located away from heat sources such as radiators, heat registers, or other products that produce heat.
6. This product should be located away from electrical motors, neon signs, fluorescent light fixtures, and other sources of electrical noise.
7. The product should be connected only to the type of power supply described on the product.
8. The AC power adaptor may be equipped with a polarized line plug. This is a safety feature. If you are unable to insert the plug into the outlet, we suggest that you contact an electrician to replace your outlet with a safer one.
9. The power supply cord should be unplugged from the outlet when the product is left unused for a long period of time.
10. Care should be taken so that objects do not fall and liquids are not spilled into the enclosure through openings.
11. The product should be serviced by qualified service personnel when:
  - The power supply cord or the plug has been damaged.
  - Objects have fallen, or liquid has been spilled into the product.
  - The product has been exposed to rain.
  - The product does not appear to operate normally.
  - The product has been damaged.
12. Do not disassemble or attempt to modify the product.

# ASSEMBLING THE STAND

Be sure that all parts are included before starting to assemble your unit.

## PARTS PROVIDED

Side Panel (A) . . . . . 2 pcs.  
 Back Panel (B) . . . . . 1 pc.  
 Pedal Board (C) . . . . . 1 pc.  
 Toe Block (D) . . . . . 2 pcs.  
 Screw (E, extra long) . . . . . 4 pcs.  
 Screw (F, long) . . . . . 8 pcs.  
 Screw (G, middle) . . . . . 3 pcs.  
 Screw (H, short) . . . . . 4 pcs.  
 Washer (I) . . . . . 4 pcs.

Spring Washer (J) . . . . . 4 pcs.  
 Round Nut (K) . . . . . 4 pcs.  
 Adjuster (L) . . . . . 1 pc.

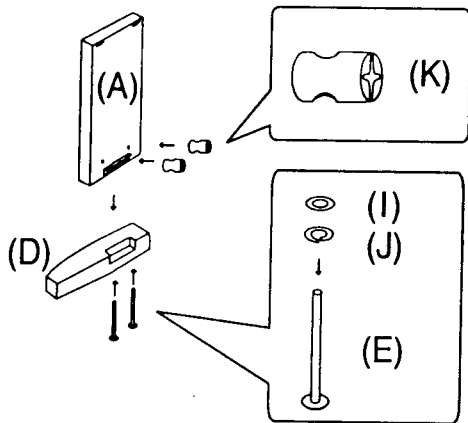
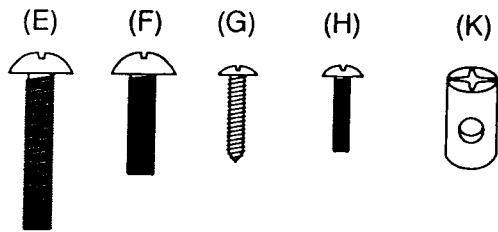

1. Insert the round nuts (K) into the holes of Side Panel (A) with keeping the nut's hole vertical. Insert the screws (E) into the spring washer and washer. Put (A) to Toe Block (D) and fasten with four screws (E) from the bottom.

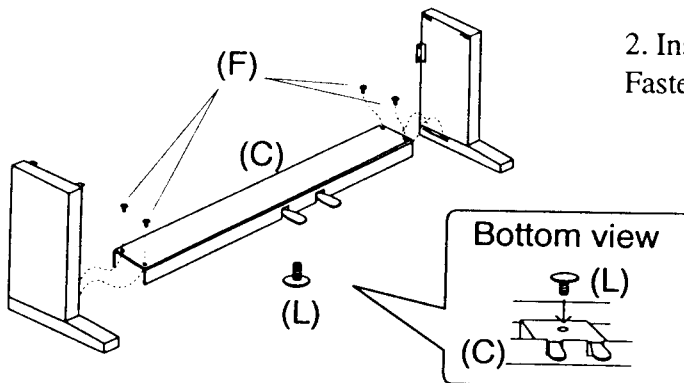

2. Insert the adjuster (L) on Pedal Board (C). Fasten (A) and (C) with four screws (F).

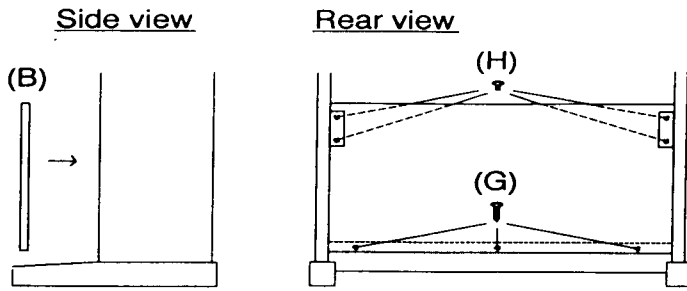

3. Hold (B) behind (A) and (C). Fasten (A) and (B) with four screws (H) and with three screws (G).

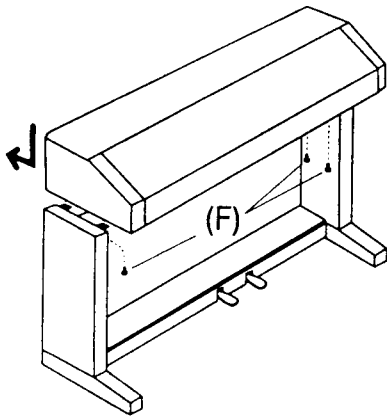

4. Place the piano on the stand. Then, slide the piano backward to place it at the appropriate point for screws. Hold the piano on the stand so that it doesn't fall from the stand. Then fasten the piano and the stand with four long screws.

**CAUTION:** Be sure to secure the piano to the stand with the screws. If you fail to do so, the unit could fall from the stand causing damage or personal injury.

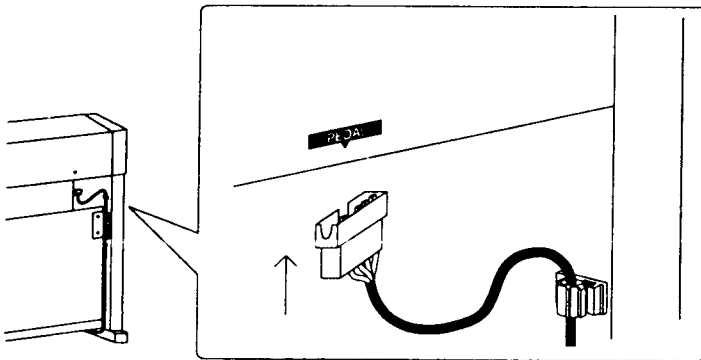

5. Insert the pedal connection cord that comes from Pedal Board (C) into the piano's pedal jack and fasten with clamps

6. Turn the adjuster (installed on the bottom of C) until it touches the floor to support the pedal board.

**NOTE:**

In order to put such another instrument as a sequencer or sound module on the top of the PN90, you should take the fallboard off the PN90. (See the note on page 20.)

# PART NAMES

---

## VOLUME SLIDER (A)

Move the volume slider to the right to increase the instrument's volume. Move the slider to the left to decrease the volume.

## FUNCTION SECTION (B)

Use these buttons to select a touch type, transpose the keyboard, or control other features (including MIDI functions).

## TONE BUTTON (C)

Select the desired instrument by pressing the appropriate button.

## EFFECTS SECTION (D)

These buttons add effects (CHORUS, REVERB and WIDE) to any sound for greater tonal richness.

## RECORDER SECTION (E)

You can record and play back up to three songs.

-PLAY/STOP button: Used to play back and stop a recorded song.

-RECORD button: Used to start recording a song.

## DEMO BUTTON (F)

To select and start a demo song, press this button and any key on the keyboard. This digital piano provides 12 demo songs. The song selected depends on the key you press. (Refer to page 10 of this manual for a list of the demo songs.) To stop the demonstration song, press this switch once more.

## POWER BUTTON (G)

This button turns the instrument on and off. Be sure to turn off the instrument when you are finished playing.

## FRONT PANEL

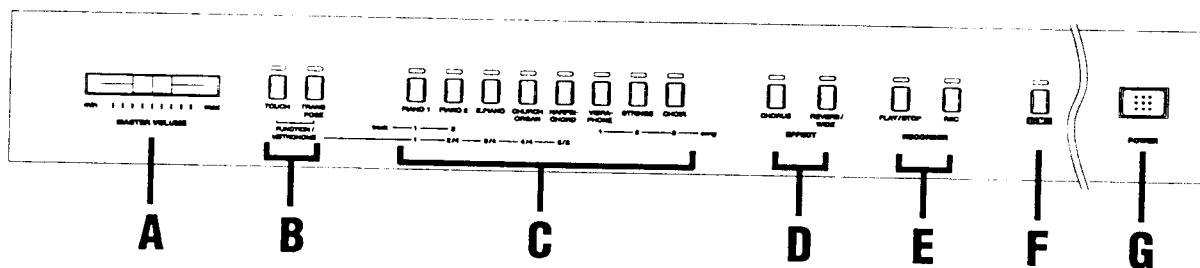

### HEADPHONES JACKS (H)

Used to connect up to two headphones to this digital piano.

### SOFT PEDAL (I)

Pressing this pedal softens the sound and also reduces its volume.

### SUSTAIN PEDAL (J)

Pressing this pedal sustains the sound even after you remove your hands from the keyboard.

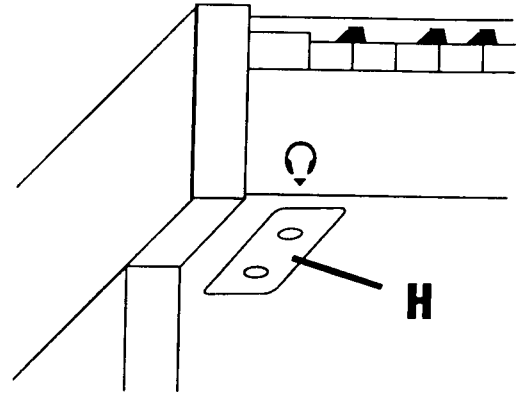

### LINE IN/OUT JACKS (K)

Connect an external amplifier and speakers, or a cassette recorder to these jacks.

### MIDI JACKS (L)

Use these jacks to connect with MIDI equipments.

### PEDAL JACKS (M)

There are two kinds of jacks. One is for the enclosed pedals. Connect the pedal cord to this jack. The other is for the optional pedals, such as KAWAI F1. Use this jack when you use the PN90 without the stand.

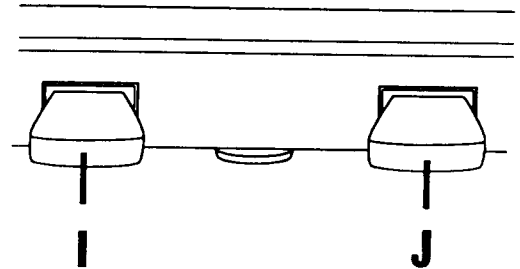

### REAR PANEL

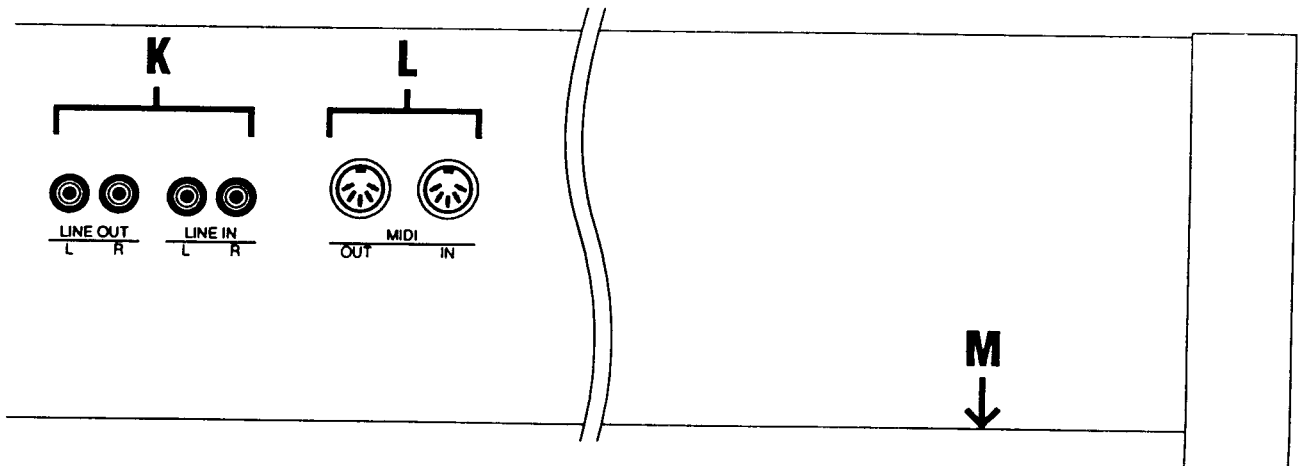

# GETTING STARTED

---

## 1. BASIC OPERATIONS

### (1) Turn on the power.

### (2) Adjust the volume.

Play a note on the keyboard and adjust the volume (Moving the slider to the right raises the volume while moving to the left lowers it.)

### (3) Choose a tone.

Pressing a TONE button automatically changes the sound made by the PN90. The LED above the selected tone button will light to indicate which tone is currently in effect.

### (4) Play.

Experiment with the various tone colors.

### (5) Dual

You can combine two sounds with DUAL mode. Simultaneously press two TONE buttons to hear two tone colors at once.

### (6) Effect

Add an effect.

-REVERB function simulates the reverberation of a music hall. This effect is "ON" when the light above the REVERB/WIDE button is lit.

When the power is turned on, the REVERB function is automatically activated. Press the button if the light isn't lit.

-WIDE is Kawai's exclusive sound enhancement system which simulates the deep reverberation of a large concert hall or cathedral.

Press the REVERB/WIDE button while the LED is lit. The LED will flash and the WIDE function will be activated. Pressing the button once again turns the REVERB and WIDE functions "OFF".

-CHORUS adds a deep richness to any sound. To activate this effect, press the CHORUS button while the REVERB/WIDE switch is "off".

### NOTE:

1. The PN90 can play up to 24 keys simultaneously (24-note polyphonic).
2. When playing in DUAL mode or when CHORUS is on, the PN90 can play up to 12 notes simultaneously (12-note polyphonic). When playing in DUAL mode while CHORUS is on, the PN90 is 6-note polyphonic.



## 2. TRANSPOSE

(1) Press the TRANSPOSE button so that the LED above it lights and the current key LED lights. (When power is turned “on”, the key is set to C.)

(2) While holding down the TRANSPOSE button, press the key button (TONE button) you wish to select. To select the key with “sharp” or “flat”, simultaneously press the buttons on either side of that key. For example, simultaneously pressing the “D” and “E” buttons selects “E-flat”.

### NOTE:

The TRANSPOSE LED will light when any key other than C is selected.

(3) To exit the TRANSPOSE function, press the TRANSPOSE button. The TRANSPOSE LED will go off and the key signature will return to C.

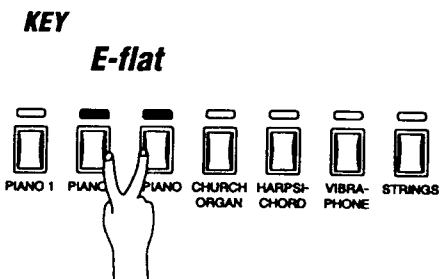
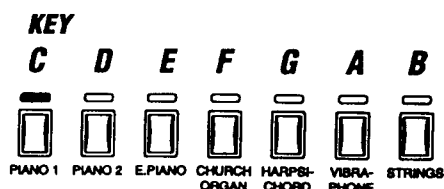

## 3. TOUCH RESPONSE

When playing a piano, the volume of the sound produced increases in direct relation to how hard a key is struck. The PN90 offers the realistic feel of an acoustic piano for practicing music. The Touch Response function simulates the standard touch of the acoustic piano when the TOUCH LED is off. When the TOUCH LED is lit, you can select other Touch Types. (Refer to the PROGRAMMING MODE section of this manual.)

## 4. DEMONSTRATION SONG

This digital piano incorporates 12 demonstration songs for your listening enjoyment.

(1) Press the DEMO button. The PN90 will begin to play the twelve demonstration songs in the following order.

	KEY	SONG
1	C . . . . .	Fantasia-Impromptu (F. Chopin)
2	C-sharp . . . .	“Love Dreams” (F. Liszt)
3	D . . . . .	“Copacabana” (Barry Manilow)
4	E-flat . . . . .	Nocturne op.9, No.2 (F. Chopin)
5	E . . . . .	“When The Saints Go Marchin’ In” (Spiritual)
6	F . . . . .	Waltz op.64, No.1 “Little Dog” (F. Chopin)
7	F-sharp . . . .	“A Whiter Shade of Pale” (Keith Reid & Gary Brooker)
8	G . . . . .	“Turkisch March” (W. A. Mozart)
9	A-flat. . . . .	“Your Song” (Elton John)
10	A . . . . .	Etude op.10, No.3 “Song of Adieu” (F. Chopin)
11	B-flat. . . . .	Brilliant Waltz op.34, No.1 (F. Chopin)
12	B . . . . .	“For Elise” (L. v. Beethoven)

(2) You can select a particular demonstration song (from the twelve shown above) by pressing the appropriate location key while pressing the DEMO button.

For example, the Fantasia-Impromptu (by Chopin) can be selected by holding down the DEMO button while pressing any C on the keyboard.

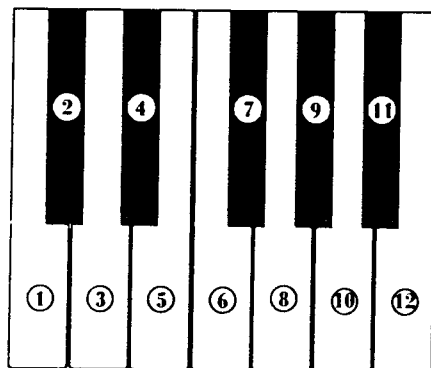

(3) To stop any demonstration song, press the DEMO button again.

# DIGITAL RECORDING FUNCTIONS

---

## 1. EASY RECORDING

(1) Press the REC button. The PN90 will be ready for recording. To cancel the recording, press the REC button again.

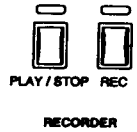

(2) Playing the piano will automatically start the recording. You can also start recording by pressing the PLAY/STOP button.

(3) Press the PLAY/STOP button when you have finished playing.

### NOTE:

Starting another recording will delete the song you previously recorded. To keep the recorded song, record using the “ADVANCED RECORDING/PLAYBACK FUNCTIONS” section.

## METRONOME/SELECT TIME AND TEMPO

The PN90's metronome function helps you record a song by beating time. The metronome beats are not recorded.

(1) To start the metronome, while holding down the TOUCH and TRANSPOSE buttons, select the time of the metronome from 1 to 6/8 and press the equivalent tone button. Then the metronome's sound will start to beat the time.

(2) To adjust the tempo, press the E.PIANO button while holding down the REC or PLAY/STOP button to make the tempo slower or press the CHURCH ORGAN button while pressing the REC or PLAY/STOP button to make the tempo faster. To make the metronome mute, press the HARPSICHORD button while holding down the REC or PLAY/STOP button. Press the HARPSICHORD button again if you would like to restart the metronome.

(3) To exit the metronome function, press the TOUCH and TRANSPOSE button at the same time and the beating sound will stop.

## 2. PLAYING BACK A SONG

(1) Press the PLAY/STOP button. The song will be played back using the same tone (voice) with which it was recorded.

(2) Press the PLAY/STOP button once again to stop the playback. If you do not press the PLAY/STOP button, playback will automatically stop when the song is finished.

You can adjust the tempo of playback. Before pressing the PLAY/STOP button, hold down the E.PIANO button while pressing the REC button to make the tempo slower or press the CHURCH ORGAN button while pressing the REC button to make the tempo faster.

## **3. ADVANCED RECORDING/PLAYBACK FUNCTIONS**

### **RECORDING MORE SONGS**

The PN90 can record and store a maximum of 3 songs. Please follow the steps below to save your songs:

(1) While holding down the REC button, press the STRINGS (Song 2) button. The LED will light to show the current song number (while the REC button is held down). The piano will be ready to record and the metronome will start when you lift your fingers off the buttons.

To turn off the metronome's sound, press the HARPSICHORD button before releasing the REC button. To cancel without recording, press the REC switch again.

(2) Play the piano. Playing the piano will automatically start the recording. You can also start recording by pressing the PLAY/STOP button.

(3) Press the PLAY/STOP button after you have finished playing.

(4) Holding down the PLAY/STOP button, press the STRINGS (Song 2) button.

(5) Releasing both buttons will play Song No.2. Playback will automatically stop when the song is finished. You can adjust the tempo of playback. Before pressing the PLAY/STOP button, hold down the E.PIANO button while pressing the REC button to make the tempo slower or press the CHURCH ORGAN button while pressing the REC button to make the tempo faster.

### **RECORDING/PLAYING BACK THE LEFT AND RIGHT HAND PARTS SEPARATELY**

The PN90 can record the parts played by the left or right hand and play back these parts separately or simultaneously. This function can be enjoyed in different ways. For example, you can practice the right-hand part of the song while playing back the recorded left-hand part, or record the melody part of the song while playing back the previously recorded accompaniment.

(1) While holding down the REC button, press the CHOIR (Song 3) button to select Song No.3. Track 1 of Song No.3 will be selected and the PN90 will be ready to record. (To turn off the metronome's sound, press the HARPSICHORD button before releasing the REC button. To cancel without recording, press the REC button again.

(2) Play the piano with your left hand. Playing the piano will automatically start the recording. You can also start recording by pressing the PLAY/STOP button.

(3) Press the PLAY/STOP button after you have finished playing.

(4) Now, to play back the left-hand part, press the PLAY/STOP button. The left-hand part you have recorded (Track 1 of Song No.3) will be played back. You can practice the right-hand part along with the recorded part.

You can adjust the tempo. Before pressing the PLAY/STOP button, hold down the E.PIANO button while pressing the REC button to make the tempo slower or press the CHURCH ORGAN button while pressing the REC button to make the tempo faster.

(5) Let's record the right-hand part while listening to the left-hand part. Holding down the REC button, press the PIANO 2 (Track 2) button. The Track 1 LED will light and the Track 2 LED will flash to indicate that the piano is ready to record. (To turn off the metronome's sound press the HARPSICHORD button before releasing the REC button. To cancel without recording, press the REC switch again.

(6) Play the right-hand part of the same. Pressing any key will start playing back the recorded left-hand part (Track 1) while you play (and record) the right-hand part. You can also start recording by pressing the PLAY/STOP button if the right-hand part does not start on the first beat of the song.

(7) Press the PLAY/STOP button after you have finished playing.

### **PLAYING BACK THE LEFT- AND RIGHT-HAND PARTS SEPARATELY**

After your succeeded in recording the left- and right-hand parts (Track 1 and Track 2) separately, it is possible to play back the two parts (Tracks) by themselves or together. The following example shows how to play back only Track 2.

(1) Select and press one of the Song buttons (VIBRAPHONE/Song 1, STRINGS/Song 2 or CHOIR/Song 3) while pressing the PLAY/STOP button.

(2) Holding down the PLAY/STOP button, press the PIANO 1/Track 1 button.

The PIANO 1/Track 1 switch LED will be turned "off". If you need to turn the Track 1 back "on", press the PIANO 1/Track 1 switch once again.

(3) Releasing both switches will play back only Track 2.

You can adjust the tempo. Before pressing the PLAY/STOP button, hold down the E.PIANO button while pressing the REC button to make the tempo slower or press the CHURCH ORGAN button while pressing the REC button to make the tempo faster.

## 4. DELETING A SONG/TRACK

This function allows you to delete songs that were not recorded correctly or songs that you do not want to listen to any more.

(1) Simultaneously hold down the PLAY/STOP button and the REC button.

(2) The LEDs will light to show you where songs have been recorded.

While holding down both the PLAY/STOP and REC buttons, press the song or track button that corresponds to the song or track you want to delete.

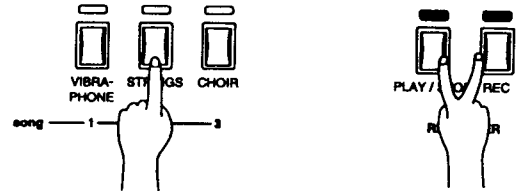

(3) Releasing all the buttons will delete the specified song or track.

To delete more than one song or track, repeat (1) to (3).

### NOTE:

- The total memory capacity of the recorder is approximately 1,200 notes. Recording will stop if the memory becomes full during recording. However, the notes recorded before the interruption will be retained.
- The recorder memory will be saved after turning off the power. However, memory may be lost if the power remains off for more than 10 days.
- To delete all recorded songs (reset), hold down the PLAY/STOP and REC buttons while you turn the power "off" and turn "on" once again.

# PROGRAMMING MODE

---

The Programming Mode gives you access to many other useful features on your PN90. To use the Programming Mode functions, press a key on the keyboard while holding down the TOUCH and TRANSPOSE buttons. To exit the Programming Mode, release the TOUCH and TRANSPOSE buttons.

The followings are functions that can be selected through Programming Mode:

- SELECTING A TOUCH TYPE (C or D or E key)
- TUNING (C-sharp or E-flat key)
- MIDI CHANNEL SELECT (F or G or A key)
- TURNING SENDING MIDI PROGRAM NUMBER ON AND OFF (B-flat key)
- TURNING MIDI MULTITIMBRE ON AND OFF (A-flat key)
- MIDI LOCAL CONTROL ON AND OFF (F-sharp key)
- RESET (B key)

## 1. SELECTING A TOUCH TYPE

Your digital piano lets you select from four different “Touch” types as follows:

- NORMAL:** The standard setting which produces volume in direct proportion to your force on the keys. This setting is the most similar to an acoustic piano. This digital piano automatically selects this Touch Type when the power is turned on.
- LIGHT:** For those still developing finger strength, such as a child, a louder sound is produced even when played with a soft touch.
- HEAVY:** Perfect for those with strong fingers or for practicing with a hard touch.
- CONSTANT:** For tone colors like organ or harpsichord, and for playing some contemporary music with the piano sound, loud sound is produced regardless of your force on the keys.

(1) To select the “LIGHT”, “CONSTANT” or “HEAVY” Touch Type, press one of the following keys on the keyboard while holding down the TOUCH and TRANSPOSE switches.

- Any C key: Selects the “LIGHT” Touch Type
- Any D key: Selects the “HEAVY” Touch Type
- Any E key: Selects the “CONSTANT” Touch Type

(2) Release both hands after selecting the Touch Type to exit the programming mode.

When the TOUCH LED is off, the “NORMAL” Touch Type is automatically selected. When an alternative touch type is selected using the above procedure, the TOUCH LED will light. The TOUCH button is a toggle switch. Pressing the button turns on the LED. Pressing it a second time turns off the LED.

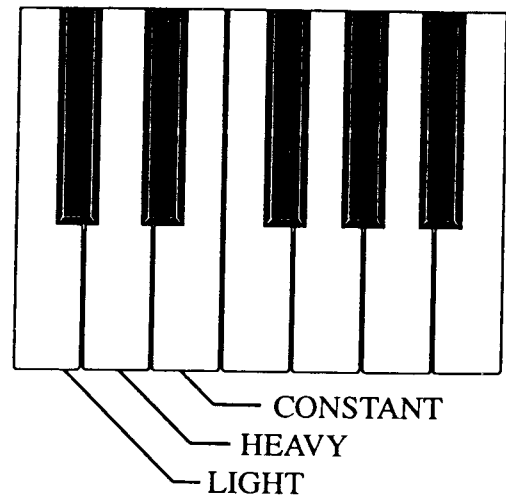

## 2. TUNING

This function allows you to adjust the piano's pitch to match recordings or other instruments in an ensemble.

(1) To lower the pitch press any C-sharp key while holding down the TOUCH and TRANSPOSE buttons. To raise the pitch press any E-flat key while holding down the TOUCH and TRANSPOSE buttons.

(2) Release the both hands after finding the desired pitch.

The range of tuning is +/-50 cents (100 cents = a half tone). Each press of the key will change the tuning 1.56 cents. Press the key repeatedly until you arrive at the desired pitch.

## 3. MIDI CHANNEL SELECT

In order to exchange MIDI information with a another MIDI instrument, you must first set the two connected instruments to the same channel.

(1) If you press any A key while holding down the TOUCH and TRANSPOSE buttons, the MIDI channel will increase by one each time you press the key. MIDI channel will progress from 1 to 16 and automatically cycle back to channel 1. If you press any G key, the channel will be set to 1 regardless of what channel is currently selected. And, if you press any F key while holding down the TOUCH and TRANSPOSE buttons, the MIDI channel will decrease by 1 each time you press the key.

(2) Release the both hands after selecting the channel.

When the power is first turned on, the PN90 always selects channel 1.

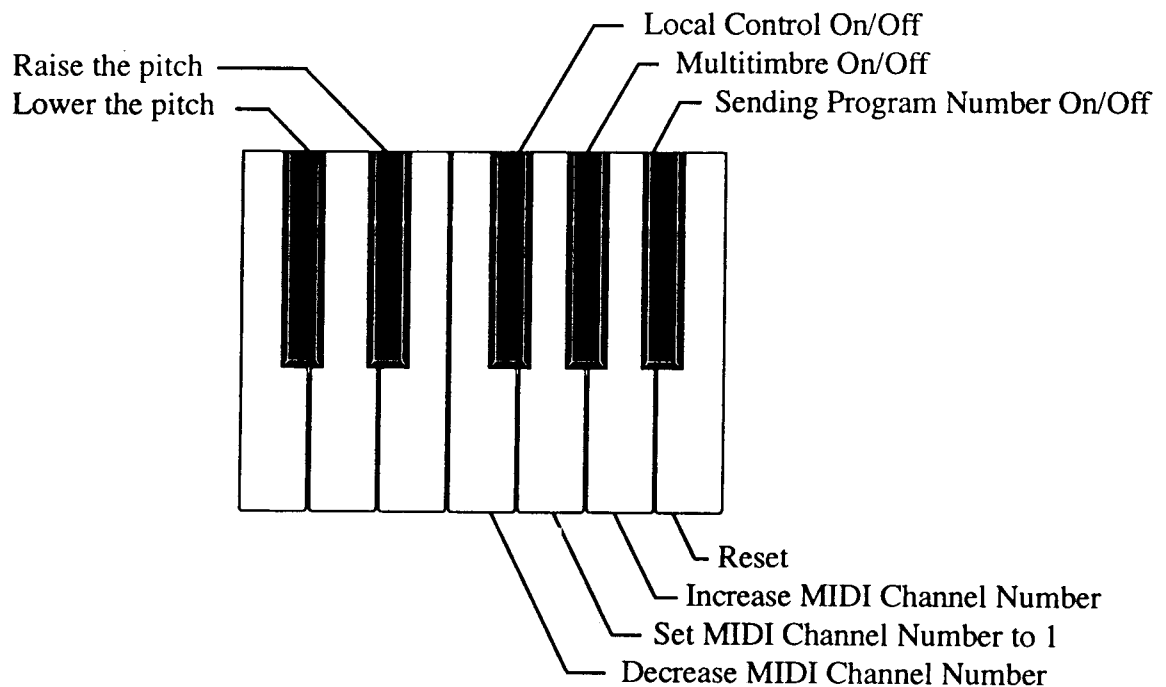



## 4. TURNING SENDING PROGRAM NUMBER ON AND OFF

You can use 8 program numbers to transmit data of tone color. Program Number 1 transmits the data of PIANO 1, Program Number 2 transmits PIANO 2, Program Number 3 transmits E.PIANO, Program Number 6 transmits HARPSICHORD, Program Number 7 transmits VIBRAPHONE, Program Number 8 transmits STRINGS, Program Number 12 transmits CHURCH ORGAN and Program Number 13 transmits CHOIR.

(1) If you press any B-flat key while holding down the TOUCH and TRANSPOSE buttons, this function is set to "off" and the PN90 does not transmit the data corresponding to the tone selected on the panel. If you press the B-flat key again while holding down the TOUCH and TRANSPOSE buttons, this function returns to "on" and you can select the tone to transmit as data.

(2) Release both hands after selecting either "on" or "off" of sending program number. When the power is first turned on, the SENDING MIDI PROGRAM NUMBER is always "on".

## 5. TURNING MULTITIMBRE ON AND OFF

Normally, the procedure described in the MIDI CHANNEL SELECT section is used to transmit or receive data on only one MIDI channel (any one of 1 through 16). But by turning the MULTI TIMBRE function "on", you can receive more than one MIDI channel and simultaneously play a different timbre on each channel (See the chart below). With this feature, you can use a sequencer such as the Kawai Q-80EX or DRP-10 to create performances with contain a variety of timbres on the digital piano. The term "Multi Timbre" is derived from this ability to play multiple timbre simultaneously.

CHANNEL	TONE COLOR	CHANNEL	TONE COLOR
1	PIANO 1	9	
2	PIANO 2	10	
3	E.PIANO	11	
4		12	CHURCH ORGAN
5		13	CHOIR
6	HARPSICHORD	14	
7	VIBRAPHONE	15	
8	STRINGS	16	

### NOTE:

The tone colors are assigned to and fixed in each channel, so you can't change the program numbers. The blank channels don't receive MIDI data in this MULTITIMBRE function.

(1) If you press any A-flat key while holding down the TOUCH and TRANSPOSE buttons, the MIDI MULTITIMBRE will be set to “on”. If you press any A-flat key again while holding down the TOUCH and TRANSPOSE buttons, the MIDI MULTITIMBRE function returns to “off”.

(2) Release both hands after selecting the desired setting.

When power is first turned on, the MIDI MULTITIMBRE setting is always off.

## **6. LOCAL CONTROL ON AND OFF**

This mode is used to control whether or not the sound from the piano’s keyboard will be heard.

(1) If you press any F-sharp key while holding down the TOUCH and TRANSPOSE buttons, the MIDI LOCAL CONTROL will be set to “off”. If you press again any F-sharp key while holding down the TOUCH and TRANSPOSE buttons, the MIDI LOCAL CONTROL returns to “on”.

(2) Release both hands after selecting the desired setting.

## **7. RESET**

When the RESET procedure is used, most of the PN90’s original factory settings (same as the one when you turn on the instrument) will be restored.

The original factory settings restored with this function are:

- MIDI Transmit Channel Channel 1
- MIDI Program Change On
- MIDI Multitimbre Off
- MIDI Local Control On
- Tuning +/-0
- Touch Type (When the TOUCH LED is flashing) LIGHT
- Tempo (Metronome of the Recorder) 120/min.

(1) Press any B-key while holding down the TOUCH and TRANSPOSE buttons.

(2) Release both hands after following this procedure.

# MIDI

---

The term MIDI is an acronym for Musical Instrument Digital Interface, an international standard for connecting synthesizers, sequencers (digital recorders) and other electronic instruments so that they can exchange performance data.

The PN90 is equipped with two MIDI jacks for exchanging data: MIDI IN and MIDI OUT. Each uses a special cable with a DIN connector.

MIDI IN : For receiving note, program change and other data.

MIDI OUT : For sending note, program change and other data.

## MIDI EXAMPLES

### (1) Connection to another MIDI compatible keyboard or sound generator module

When connected as shown in the illustration, data on how the digital piano is played (which keys are struck) can be sent to another MIDI instrument. Plus, the sound from the PN90 can be layered over the sound of the other instrument.

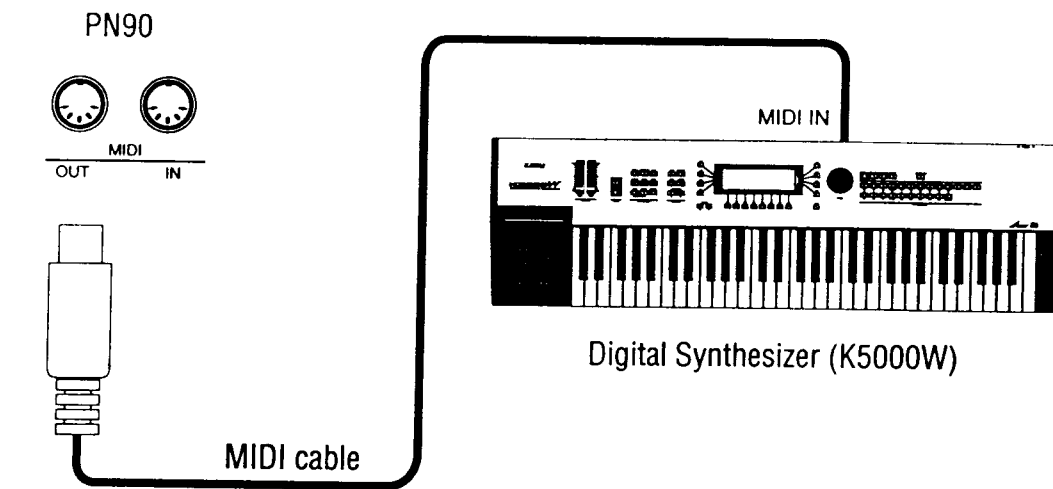

### Layering Sounds

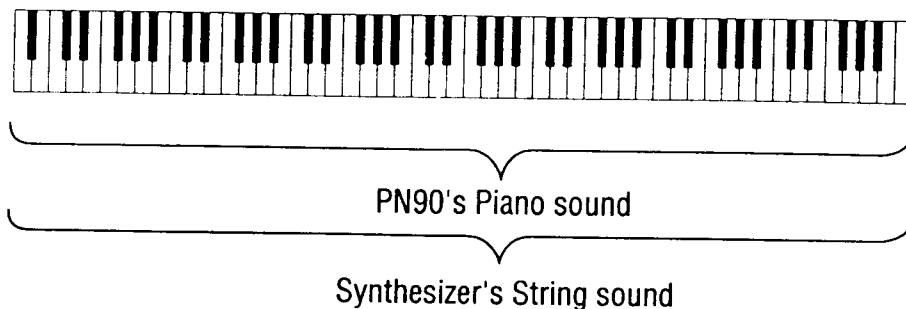

## (2) Connection to an external sequencer and sound generator module

When connected as shown in the illustration, you can record songs played on the PN90 with a sequencer, and use the module's tones (such as piano, harpsichord and other different tones) controlled by the PN90's MULTI TIMBRE function to create a multi-layer MIDI recording.

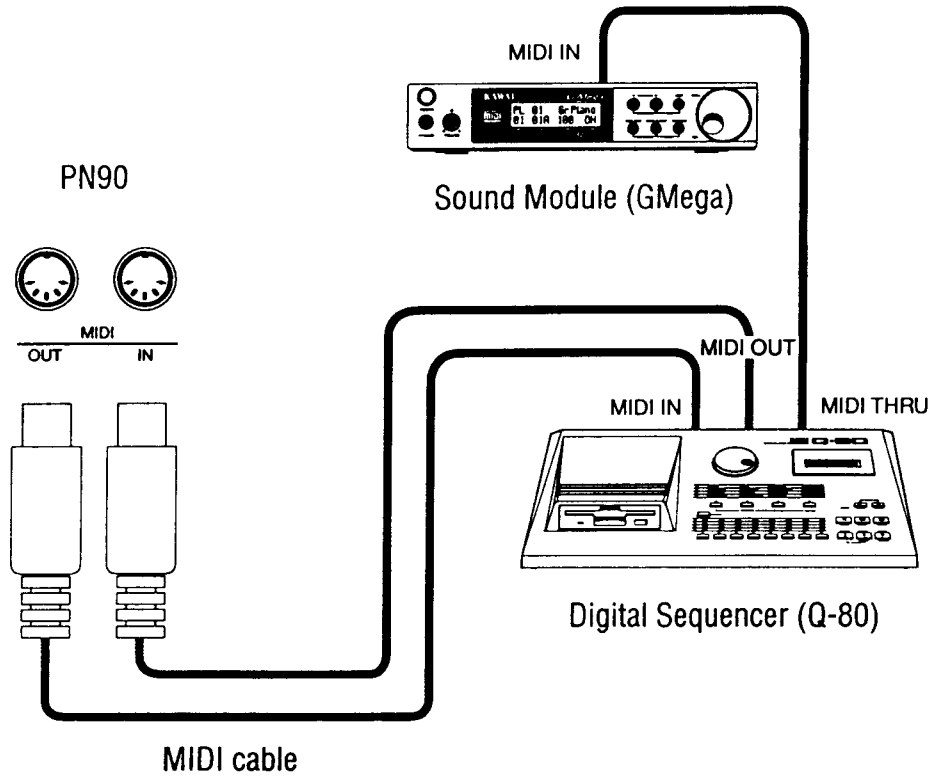

### NOTE:

When using a sequencer or sound module and putting it on the top of the PN90, you should remove the fallboard.

- (1) Open the fallboard and you see the pivot with the spring down the right side of the board.
- (2) Slide the lever of the pivot inside and hold it. Then lift the fallboard up and take it off.

# SPECIFICATIONS

---

Keyboard	88 Weighted Keys
Touch Type	4 Types (Normal, Light, Heavy, Constant)
Max Polyphony	24 Notes
Tones	8 Tones (PIANO1, PIANO2, E.PIANO, CHURCH ORGAN, HARPSICHORD, VIBRAPHONE, STRINGS, CHOIR)
Effects	Reverb, Wide, Chorus
Digital Recorder	3-Song, 2-Track, 1,200-Notes
Other Functions	Transpose, Tuning, MIDI Functions, 12 Demo Songs
Pedals	2 (Soft, Sustain)
Jacks	Headphones x 2, Pedals x 2, MIDI IN/OUT, LINE IN/OUT (L, R)
Speakers	16 cm x 2 (6 1/4"), 20 W x 2
Dimensions	137 x 45 x 79 (cm), 54" x 17 1/2" x 31 1/8"
Weight	45 kg (99 lbs.)

Specifications are subject to change without notice.

# MIDI IMPLEMENTATION CHART

KAWAI DIGITAL PIANO  
MODEL: PN90

Date: October, 1997  
Version: 1.0

FUNCTION	TRANSMITTED	RECEIVED	REMARKS
Basic Channel (Default) (Changed)	1 1-16	1 1-16	
Mode (Default) (Message) (Altered)	3 x *****	1 1 x	
Note Number (True Voice)	15-113* *****	0-127 0-127	
Velocity (Note ON) (Note OFF)	O: 9nH v=1-127 x: 8nH v=0	O x	
After Touch Key's Channel's	x x	x x	
Pitch Bend	x	x	
Control Change 7 64 67	x O (Right pedal) O (Left pedal)	O O O	Volume Damper pedal Soft pedal
Program Change True	O *****	O	
System Exclusive Common	O	O	
(Song Position) (Song Select) (Tune)	x x x	x x x	
System: Real Time (Clock) (Commands)	x x	x x	
Others (Local ON/OFF) (All Notes OFF) (Active Sense) (Reset)	x x O x	O O O x	
Notes: Value varies when transposed. 21-108 when not transposed.			
Mode 1: OMNI ON, POLY    Mode 2: OMNI ON, MONO Mode 3: OMNI OFF, POLY    Mode 4: OMNI OFF, MONO			

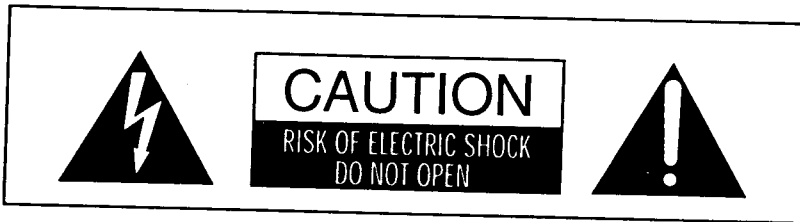

**WARNING**  
TO REDUCE THE RISK OF  
FIRE OR ELECTRIC  
SHOCK, DO NOT EXPOSE  
THIS PRODUCT TO RAIN  
OR MOISTURE.

**AVIS : RISQUE DE CHOC ELECTRIQUE - NE PAS OUVRIR.**

TO REDUCE THE RISK OF ELECTRIC SHOCK, DO NOT REMOVE COVER (OR BACK).  
NO USER-SERVICEABLE PARTS INSIDE. REFER SERVICING TO QUALIFIED SERVICE PERSONNEL.



The lightning flash with arrowhead symbol, within an equilateral triangle, is intended to alert the user to the presence of uninsulated "dangerous voltage" within the product's enclosure that may be of sufficient magnitude to constitute a risk of electric shock to persons.



The exclamation point within an equilateral triangle is intended to alert the user to the presence of important operating and maintenance (servicing) instructions in the literature accompanying the product.

**CAUTION:** TO PREVENT ELECTRIC SHOCK, MATCH WIDE BLADE OF PLUG TO WIDE SLOT, FULLY INSERT.

**ATTENTION:** POUR EVITER LES CHOCES ELECTRIQUES, INTRODUIRE LA LAME LA PLUS LARGE DE LA FICHE DANS LA BORNE CORRESPONDANTE DE LA PRISE ET POUSSER JUSQU'AU FOND.

Instruction for AC power cord (U.K.)

Do not plug either terminal of the power cord to the ground of the AC outlet on the wall.

#### FCC Information (U.S.A.)

This equipment has been tested and found to comply with the limits for a Class B digital device, pursuant to Part 15 of the FCC Rules. These limits are designed to provide reasonable protection against harmful interference in a residential installation. This equipment generates, uses and can radiate radio frequency energy and, if not installed and used in accordance with the instructions, may cause harmful interference to radio communications.

If this equipment does cause harmful interference to radio or television reception, which can be determined by turning the equipment off and on, the user is encouraged to try to correct the interference by one or more of the following measures:

- Reorient or relocate the receiving antenna.
- Increase the separation between the equipment and receiver.
- Connect the equipment into an outlet on a different electrical circuit from the receiver.
- Consult the dealer or an experienced radio/TV technician for help.

This instrument complies with the limits for a class B digital apparatus, pursuant to the Radio Interference Regulations, C.R.C., c. 1374.

**KAWAI**