

KAWAI
DIGITAL PIANO
PN81

OWNER'S MANUAL

Thank you for choosing this Kawai PN81 Digital Piano.
 Your new PN81 is a high-quality instrument offering the very latest in leading-edge music technology.
 This manual contains valuable information that will help you make full use of your PN81's many capabilities. Please read it carefully and keep it handy for further reference.





TABLE OF CONTENTS

	Page
Important Safety Instructions	4
Assembling The Stand	6
Part Names	8
Getting Started	
1. Basic Operations	10
2. Transpose	11
3. Touch Response	11
4. Demonstration Songs	12
Digital Recording Functions	
1. Easy Recording	13
2. Playing Back A Song	14
3. Advanced Recording/Playback Functions	14
4. Deleting A Song/Track	16
Programming Mode	
1. Selecting A Touch Type	17
2. Tuning	18
3. MIDI Channel Select	18
4. Turning Sending Program Number On And Off	19
5. Turning Multitimbre On And Off	19
6. Local Control On And Off	20
7. Reset	20
MIDI	21
SPECIFICATIONS	23
MIDI IMPLEMENTATION CHART	24

Safety Instructions

Read this section carefully before using this product. It contains important safety warnings and cautions, which must be followed.

The following symbols are used on the product and their meanings are given below.

	CAUTION Risk of electric shock. Do not open.			Alerts the user to the risk of electric shock.
CAUTION: To prevent fire and electric shock, do not expose the product to rain or moisture.				Alerts the user to the presence of general cautions and warnings in the instruction manual accompanying the product.

	WARNING	Indicates a potential hazard that could result in death or serious injury if the product is handled incorrectly.
---	----------------	--

	CAUTION	Indicates a potential hazard that could result in injury or damage to the product or other property if the product is handled incorrectly.
---	----------------	--





Examples of Picture Symbols

	denotes that care should be taken. The example instructs the user to take care not to allow fingers to be trapped.
---	---

	denotes a prohibited operation. The example instructs that disassembly of the product is prohibited.
---	---

	denotes an operation that should be carried out. The example instructs the user to remove the power cord plug from the AC outlet.
---	--

WARNING

The product should be connected to an AC outlet of the specified voltage.		  	<ul style="list-style-type: none"> ● Use the AC adapter supplied with the product or one recommended by Kawai. ● If you are going to use an AC power cord, make sure that its has the correct plug shape and conforms to the specified power voltage. ● Failure to do so may result in fire.
--	---	---	---

Do not insert or disconnect the power cord plug with wet hands.			Doing so may cause electric shock.
--	---	---	------------------------------------

Take care not to drop the product.			Please note that the product is heavy and must be carried by more than two persons. Dropping the product may result in breakdown.
---	---	---	---

The chair must be used properly (it must be used only when playing the product).		<ul style="list-style-type: none"> ● Do not play with it or stand on it. ● Only one person is allowed to sit on it. ● Do not sit on it during height adjustment. ● Do not sit on it when opening the lid. 	Doing so may cause the chair to fall over or your fingers to be trapped, resulting in injury.
---	---	---	---

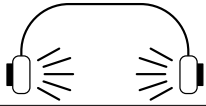
When using the headphones, do not listen for long periods of time at high volume levels.			Doing so may result in hearing problems.
---	---	---	--

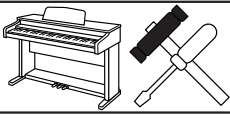
Do not disassemble, repair or modify the product.			Doing so may result in product breakdown, electric shock or short-circuit.
--	---	---	--

When disconnecting the AC power cord's plug, always hold the plug and pull it to remove it.			<ul style="list-style-type: none"> ● Pulling the AC power cord itself may damage the cord, causing a fire, electric shock or short-circuit.
--	---	---	--

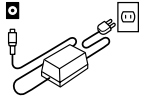
If the product will not be used for a long time, unplug the AC power cord from the AC outlet.			<ul style="list-style-type: none"> ● Failure to do so may cause fire in case of lightning. ● Failure to do so may over-heat the product, resulting in fire.
--	---	---	---



CAUTION

Do not use the product in the following areas.

- Areas, such as those near windows, where the product is exposed to direct sunlight
- Extremely hot areas, such as near a heater
- Extremely cold areas, such as outside
- Extremely humid areas
- Areas where a large amount of sand or dust is present
- Areas where the product is exposed to excessive vibrations



Using the product in such areas may result in product breakdown.

When you close the keyboard cover, close it gently.



Closing it roughly may trap your fingers, resulting in injury.

Before connecting cords, make sure that the power to this product and other devices is turned OFF.



Failure to do so may cause breakdown of this product and other devices.

Take care not to allow any foreign matter to enter the product.



Entry of water, needles or hair pins may result in breakdown or short-circuit.

Do not lean against the keyboard.



Doing so may cause the product to fall over, resulting in injury.

Do not place the product near electrical appliances such as TVs and radios.

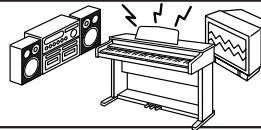

- Doing so may cause the product to generate noise.
- If the product generates noise, move the product sufficiently away from the electrical appliance or connect it to another AC outlet.

When connecting the AC power cord and other cords, take care not to get them tangled.

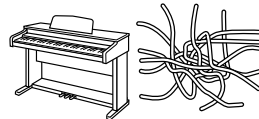

Failure to do so may damage them, resulting in fire, electric shock or short-circuit.

Do not wipe the product with benzene or thinner.



- Doing so may result in discoloration or deformation of the product.
- When cleaning the product, put a soft cloth in lukewarm water, squeeze it well, then wipe the product.

Do not stand on the product or exert excessive force.



- Doing so may cause the product to become deformed or fall over, resulting in breakdown or injury.

Notes on Repair

Should an abnormality occur in the product, immediately turn the power OFF, disconnect the power cord plug, and then contact the shop from which the product was purchased.

This equipment has been tested and found to comply with the limits for a Class B digital device, pursuant to Part 15 of the FCC Rules. These limits are designed to provide reasonable protection against harmful interference in a residential installation. This equipment generates, uses and can radiate radio frequency energy and, if not installed and used in accordance with the instructions, may cause harmful interference to radio communications.

If this equipment does cause harmful interference to radio or television reception, which can be determined by turning the equipment off and on, the user is encouraged to try to correct the interference by one or more of the following measures:

- Reorient or relocate the receiving antenna.
- Increase the separation between the equipment and receiver.
- Connect the equipment into an outlet on a different electrical circuit from the receiver.
- Consult the dealer or an experienced radio/TV technician for help.

This instrument complies with the limits for a class B digital apparatus, pursuant to the Radio Interference Regulations, C.R.C., c. 1374.

ASSEMBLING THE STAND

Be sure that all parts are included before starting to assemble your unit.

PARTS PROVIDED

Side Panel (A)	2 pcs.
Back Panel (B)	1 pc.
Pedal Board (C)	1 pc.
Toe Block (D)	2 pcs.
Screw (E, extra long)	4 pcs.
Screw (F, long)	8 pcs.
Screw (G, middle)	3 pcs.
Screw (H, short)	4 pcs.
Washer (I)	4 pcs.

Spring Washer (J)	4 pcs.
Round Nut (K)	4 pcs.
Adjuster (L)	1 pc.

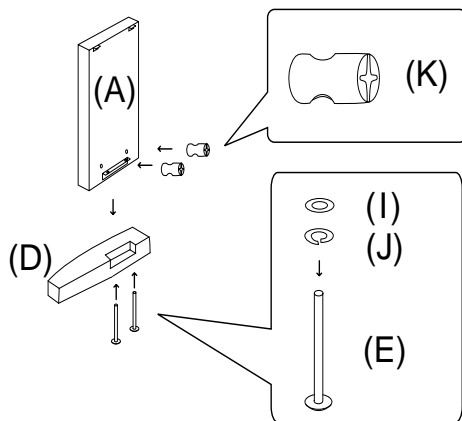
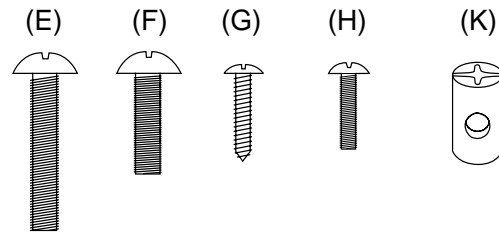

1. Insert the round nuts (K) into the holes of Side Panel (A) with keeping the nut's hole vertical. Insert the screws (E) into the spring washer and washer. Put (A) to Toe Block (D) and fasten with four screws (E) from the bottom.

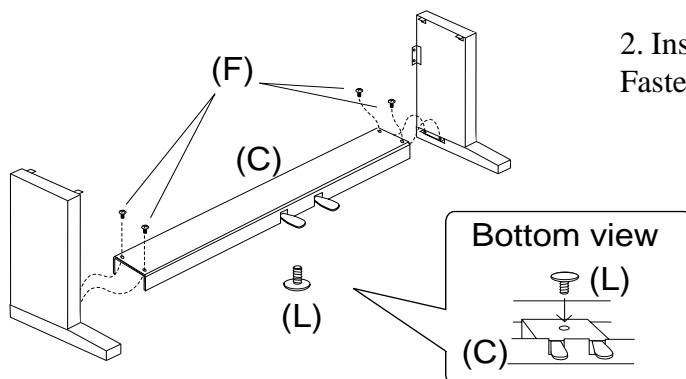

2. Insert the adjuster (L) on Pedal Board (C). Fasten (A) and (C) with four screws (F).

Side view

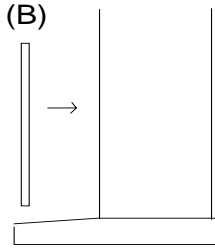

Rear view

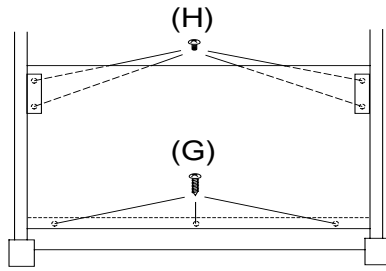

3. Fasten (A) and (B) with four screws (H) from the front and fasten (B) and (C) with three screws (G) from the back.

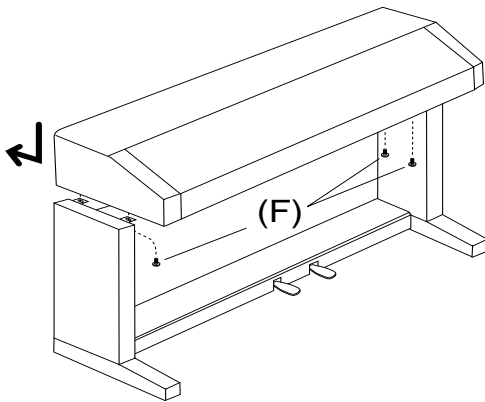

4. Place the piano on the stand. Then, slide the piano backward to place it at the appropriate point for screws. Hold the piano on the stand so that it doesn't fall from the stand. Then fasten the piano and the stand with four long screws.

CAUTION: Be sure to secure the piano to the stand with the screws. If you fail to do so, the unit could fall from the stand causing damage or personal injury.

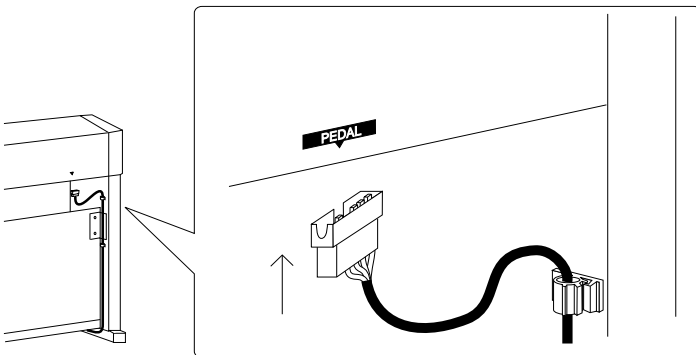

5. Insert the pedal connection cord that comes from Pedal Board (C) into the piano's pedal jack and fasten with clamps

6. Turn the adjuster (installed on the bottom of C) until it touches the floor to support the pedal board.

PART NAMES

POWER BUTTON (A)

This button turns the instrument on and off. Be sure to turn off the instrument when you are finished playing.

VOLUME SLIDER (B)

Move the volume slider to the right to increase the instrument's volume. Move the slider to the left to decrease the volume.

TONE BUTTON (C)

Select the desired instrument by pressing the appropriate button. When you use the RECORDER function, you can select the track, song number and tempo with these buttons.

RECORDER SECTION (D)

You can record and play back up to three songs.

-PLAY/STOP button: Used to play back and stop a recorded song.

-RECORD button: Used to start recording a song.

EFFECTS SECTION (E)

These buttons add effects (CHORUS, REVERB and WIDE) to any sound for greater tonal richness.

FUNCTION SECTION (F)

Use these buttons to select a touch type, transpose the keyboard, or control other features (including MIDI functions).

DEMO BUTTON (G)

To select and start a demo song, press this button and any key on the keyboard. This digital piano provides 12 demo songs. The song selected depends on the key you press. (Refer to page 10 of this manual for a list of the demo songs.) To stop the demonstration song, press this switch once more.

FRONT PANEL

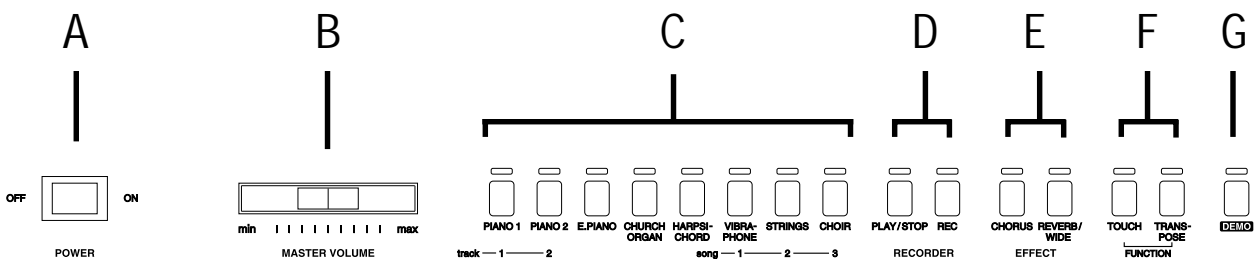

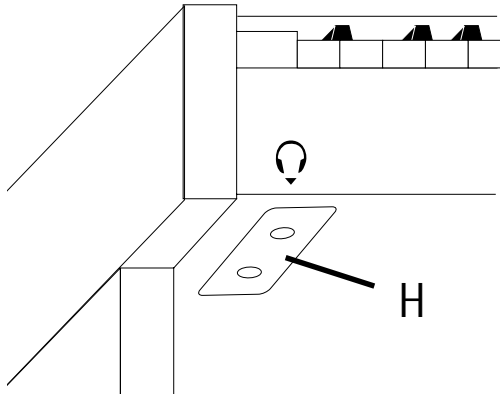

HEADPHONES JACKS (H)

Used to connect up to two headphones to this digital piano.

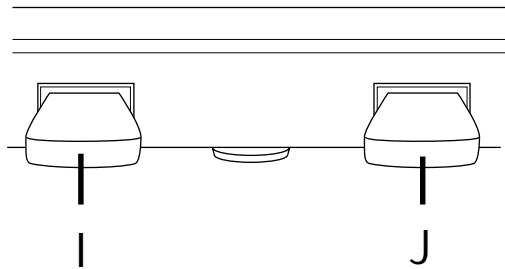

SOFT PEDAL (I)

Pressing this pedal softens the sound and also reduces its volume.

DAMPER PEDAL (J)

Pressing this pedal sustains the sound even after you remove your hands from the keyboard.

AC ADAPTOR JACK (K)

Connect the enclosed AC adaptor to this jack.

LINE IN/OUT JACKS (L)

Connect an external amplifier and speakers, or a cassette recorder to these jacks.

MIDI JACKS (M)

Use these jacks to connect with MIDI equipments.

PEDAL JACK (N)

There are two kinds of jacks. One is for the enclosed pedals. Connect the pedal cord to this jack. The other is for the optional pedals, such as KAWAI F-1. Use this jack when you use the PN81 without the stand.

REAR PANEL

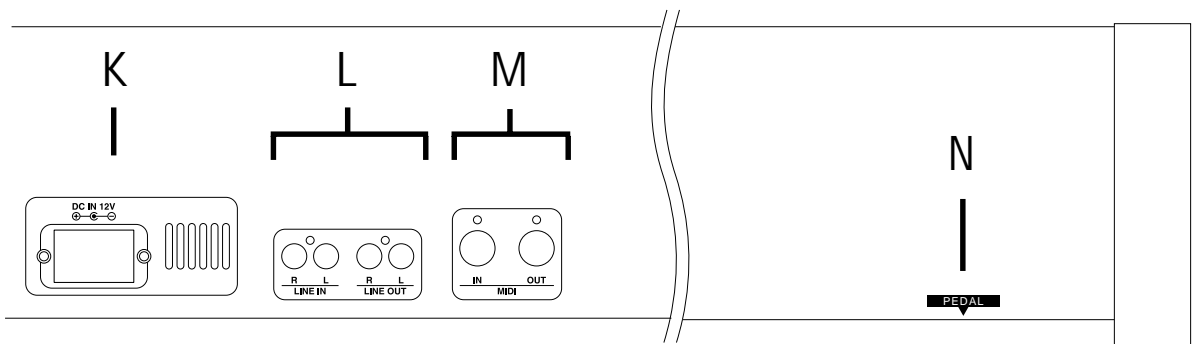

GETTING STARTED

1. BASIC OPERATIONS

(1) Turn on the power.

(2) Adjust the volume.

Play a note on the keyboard and adjust the volume (Moving the slider to the right raises the volume while moving to the left lowers it.)

(3) Choose a tone.

Pressing a TONE button automatically changes the sound made by the PN81. The LED above the selected tone button will light to indicate which tone is currently in effect.

(4) Play

Experiment with the various tone colors.

(5) Dual

You can combine two sounds with DUAL mode. Simultaneously press two TONE buttons to hear two tone colors at once.

(6) Effect

Add an effect.

-REVERB function simulates the reverberation of a music hall. This effect is “ON” when the light above the REVERB/WIDE button is lit.

(When the power is turned on, the REVERB function is automatically activated.) Press the button if the light isn’t lit.

-WIDE is Kawai’s exclusive sound enhancement system which simulates the deep reverberation of a large concert hall or cathedral.

Press the REVERB/WIDE button while the LED is lit. The LED will flash and the WIDE function will be activated. Pressing the button once again turns the REVERB and WIDE functions “OFF”.

-CHORUS adds a deep richness to any sound. To activate this effect, press the CHORUS button while the REVERB/WIDE switch is “off”.

NOTE:

1. The PN81 can play up to 24 keys simultaneously (24-note polyphonic).

2. When playing in DUAL mode or when CHORUS is on, the PN81 can play up to 12 notes simultaneously (12-note polyphonic). When playing in DUAL mode while CHORUS is on, the PN81 is 6-note polyphonic.

2. TRANSPOSE

(1) Press the TRANSPOSE button so that the LED above it lights and the current key LED lights. (When power is turned “on”, the key is set to C.)

(2) While holding down the TRANSPOSE button, press the key button (TONE button) you wish to select. To select the key with “sharp” or “flat”, simultaneously press the buttons on either side of that key. For example, simultaneously pressing the “D” and “E” buttons selects “E-flat”.

NOTE:

The TRANSPOSE LED will light when any key other than C is selected.

(3) To exit the TRANSPOSE function, press the TRANSPOSE button. The TRANSPOSE LED will go off and the key signature will return to C.

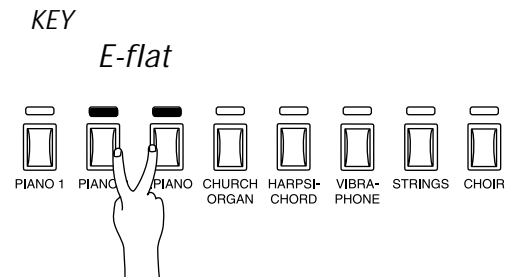
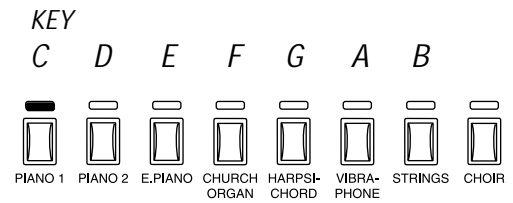

3. TOUCH RESPONSE

When playing a piano, the volume of the sound produced increases in direct relation to how hard a key is struck. The PN81 offers the realistic feel of an acoustic piano for practicing music. The Touch Response function simulates the standard touch of the acoustic piano when the TOUCH LED is off. When the TOUCH LED is lit, you can select other Touch Types. (Refer to the PROGRAMMING MODE section of this manual.)

4. DEMONSTRATION SONG

This digital piano incorporates 12 demonstration songs for your listening enjoyment.

(1) Press the DEMO button. This PN81 will begin to play the twelve demonstration songs in the following order.

	KEY	SONG
1	C	Fantasia-Impromptu (F. Chopin)
2	C-sharp	“Love Dreams” (F. Liszt)
3	D	“Copacabana” (Barry Manilow)
4	E-flat	Nocturne op.9, No.2 (F. Chopin)
5	E	“When The Saints Go Marchin’In” (Spiritual)
6	F	Waltz op.64, No.1 “Little Dog” (F. Chopin)
7	F-sharp	“A Whiter Shade of Pale” (Keith Reid & Gary Brooker)
8	G	“Turkisch March” (W. A. Mozart)
9	A-flat	“Your Song” (Elton John)
10	A	Etude op.10, No.3 “Song of Adieu” (F. Chopin)
11	B-flat	Brilliant Waltz op.34, No.1 (F. Chopin)
12	B	“For Elise” (L. v. Beethoven)

(2) You can select a particular demonstration song (from the twelve shown above) by pressing the appropriate location key while pressing the DEMO button.

For example, the Fantasia-Impromptu (by Chopin) can be selected by holding down the DEMO button while pressing any C on the keyboard.

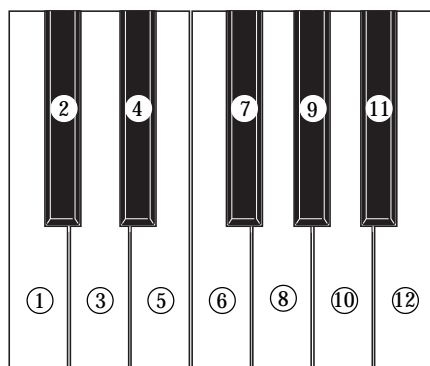

(3) To stop any demonstration song, press the DEMO button again.

DIGITAL RECORDING FUNCTIONS

1. EASY RECORDING

(1) Press the REC button. The PN81 will be ready for recording. To cancel the recording, press the REC button again.

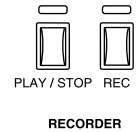

(2) Playing the piano will automatically start the recording. You can also start recording by pressing the PLAY/STOP button.

(3) Press the PLAY/STOP button when you have finished playing.

NOTE:

Starting another recording will delete the song you previously recorded. To keep the recorded song, record using the “ADVANCED RECORDING/PLAYBACK FUNCTIONS” section.

METRONOME/SELECT TIME AND TEMPO

The PN81’s metronome function helps you record a song by beating time. The metronome beats are not recorded.

(1) To start the metronome, while holding down the TOUCH and TRANSPOSE buttons, select the time of the metronome from 1 to 6/8 and press the equivalent tone button as shown below. Then the metronome’s sound will start to beat the time.

PIANO 1	1
PIANO 2	2/4
E. PIANO	3/4
CHURCH ORGAN	4/4
HARPSICHORD	6/8

(2) To adjust the tempo, press the E.PIANO button while holding down the REC or PLAY/STOP button to make the tempo slower or press the CHURCH ORGAN button while pressing the REC or PLAY/STOP button to make the tempo faster. To make the metronome mute, press the HARPSICHORD button while holding down the REC or PLAY/STOP button. Press the HARPSICHORD button again if you would like to restart the metronome.

(3) To exit the metronome function, press the TOUCH and TRANSPOSE button at the same time and the beating sound will stop.

2. PLAYING BACK A SONG

(1) Press the PLAY/STOP button. The song will be played back using the same tone (voice) with which it was recorded.

(2) Press the PLAY/STOP button once again to stop the playback. If you do not press the PLAY/STOP button, playback will automatically stop when the song is finished.

You can adjust the tempo of playback. Before pressing the PLAY/STOP button, hold down the E.PIANO button while pressing the REC button to make the tempo slower or press the CHURCH ORGAN button while pressing the REC button to make the tempo faster.

3. ADVANCED RECORDING/PLAYBACK FUNCTIONS

RECORDING MORE SONGS

The PN81 can record and store a maximum of 3 songs. Please follow the steps below to save your songs:

(1) While holding down the REC button, press the STRINGS (Song 2) button. The LED will light to show the current song number (while the REC button is held down). The piano will be ready to record with the Song 2. To cancel without recording, press the REC switch again.

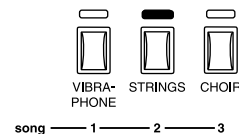

(2) Play the piano. Playing the piano will automatically start the recording. You can also start recording by pressing the PLAY/STOP button.

(3) Press the PLAY/STOP button after you have finished playing.

(4) Holding down the PLAY/STOP button, press the STRINGS (Song 2) button.

(5) Releasing both buttons will play Song No.2. Playback will automatically stop when the song is finished. You can adjust the tempo of playback. Before pressing the PLAY/STOP button, hold down the E.PIANO button while pressing the REC button to make the tempo slower or press the CHURCH ORGAN button while pressing the REC button to make the tempo faster.

RECORDING/PLAYING BACK THE LEFT AND RIGHT HAND PARTS SEPARATELY

The PN81 can record the parts played by the left or right hand and play back these parts separately or simultaneously. This function can be enjoyed in different ways. For example, you can practice the right-hand part of the song while playing back the recorded left-hand part, or record the melody part of the song while playing back the previously recorded accompaniment.

(1) While holding down the REC button, press the CHOIR (Song 3) button to select Song No.3. Track 1 of Song No.3 will be selected and the PN81 will be ready to record. (To turn off the metronome's sound, press the HARPSICHORD button before releasing the REC button. To cancel without recording, press the REC button again.

(2) Play the piano with your left hand. Playing the piano will automatically start the recording. You can also start recording by pressing the PLAY/STOP button.

(3) Press the PLAY/STOP button after you have finished playing.

(4) Now, to play back the left-hand part, press the PLAY/STOP button. The left-hand part you have recorded (Track 1 of Song No.3) will be played back. You can practice the right-hand part along with the recorded part.

You can adjust the tempo. Before pressing the PLAY/STOP button, hold down the E.PIANO button while pressing the REC button to make the tempo slower or press the CHURCH ORGAN button while pressing the REC button to make the tempo faster.

(5) Let's record the right-hand part while listening to the left-hand part. Holding down the REC button, press the PIANO 2 (Track 2) button. The Track 1 LED will light and the Track 2 LED will flash to indicate that the piano is ready to record. (To turn off the metronome's sound press the HARPSICHORD button before releasing the REC button. To cancel without recording, press the REC switch again.

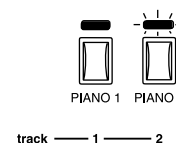

(6) Play the right-hand part of the same. Pressing any key will start playing back the recorded left-hand part (Track 1) while you play (and record) the right-hand part. You can also start recording by pressing the PLAY/STOP button if the right-hand part does not start on the first beat of the song.

(7) Press the PLAY/STOP button after you have finished playing.

PLAYING BACK THE LEFT- AND RIGHT-HAND PARTS SEPARATELY

After your succeeded in recording the left- and right-hand parts (Track 1 and Track 2) separately, it is possible to play back the two parts (Tracks) by themselves or together. The following example shows how to play back only Track 2.

(1) Select and press one of the Song buttons (VIBRAPHONE/Song 1, STRINGS/Song 2 or CHOIR/Song 3) while pressing the PLAY/STOP button.

(2) Holding down the PLAY/STOP button, press the PIANO 1/Track 1 button.

The PIANO 1/Track 1 switch LED will be turned “off”. If you need to turn the Track 1 back “on”, press the PIANO 1/Track 1 switch once again.

(3) Releasing both switches will play back only Track 2.

You can adjust the tempo. Before pressing the PLAY/STOP button, hold down the E.PIANO button while pressing the REC button to make the tempo slower or press the CHURCH ORGAN button while pressing the REC button to make the tempo faster.

4. DELETING A SONG/TRACK

This function allows you to delete songs that were not recorded correctly or songs that you do not want to listen to any more.

(1) Simultaneously hold down the **PLAY/STOP** button and the **REC** button.

The LEDs will light to show you where songs have been recorded.

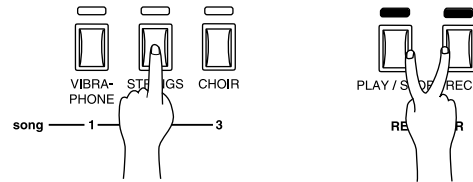

(2) While holding down both the **PLAY/STOP** and **REC** buttons, press the song or track button that corresponds to the song or track you want to delete.

(3) Releasing all the buttons will delete the specified song or track.

To delete more than one song or track, repeat (1) to (3).

NOTE:

- The total memory capacity of the recorder is approximately 1,200 notes. Recording will stop if the memory becomes full during recording. However, the notes recorded before the interruption will be retained.
- The recorder memory will be saved after turning off the power. However, memory may be lost if the power remains off for more than 10 days.
- To delete all recorded songs (reset), hold down the **PLAY/STOP** and **REC** buttons while you turn the power “off” and turn “on” once again.

PROGRAMMING MODE

The Programming Mode gives you access to many other useful features on your PN81. To use the Programming Mode functions, press a key on the keyboard while holding down the TOUCH and TRANSPOSE buttons. To exit the Programming Mode, release the TOUCH and TRANSPOSE buttons.

The followings are functions that can be selected through Programming Mode:

- SELECTING A TOUCH TYPE (C or D or E key)
- TUNING (C-sharp or E-flat key)
- MIDI CHANNEL SELECT (F or G or A key)
- TURNING SENDING MIDI PROGRAM NUMBER ON AND OFF (B-flat key)
- TURNING MIDI MULTITIMBRE ON AND OFF (A-flat key)
- MIDI LOCAL CONTROL ON AND OFF (F-sharp key)
- RESET (B key)

1. SELECTING A TOUCH TYPE

Your digital piano lets you select from four different “Touch” types as follows:

- NORMAL:** The standard setting which produces volume in direct proportion to your force on the keys. This setting is the most similar to an acoustic piano. This digital piano automatically selects this Touch Type when the power is turned on.
- LIGHT:** For those still developing finger strength, such as a child, a louder sound is produced even when played with a soft touch.
- HEAVY:** Perfect for those with strong fingers or for practicing with a hard touch.
- CONSTANT:** For tone colors like organ or harpsichord, and for playing some contemporary music with the piano sound, loud sound is produced regardless of your force on the keys.

(1) To select the “LIGHT”, “CONSTANT” or “HEAVY” Touch Type, press one of the following keys on the keyboard while holding down the TOUCH and TRANSPOSE switches.

- Any C key: Selects the “LIGHT” Touch Type
- Any D key: Selects the “HEAVY” Touch Type
- Any E key: Selects the “CONSTANT” Touch Type

(2) Release both hands after selecting the Touch Type to exit the programming mode.

When the TOUCH LED is off, the “NORMAL” Touch Type is automatically selected. When an alternative touch type is selected using the above procedure, the TOUCH LED will light. The TOUCH button is a toggle switch. Pressing the button turns on the LED. Pressing it a second time turns off the LED.

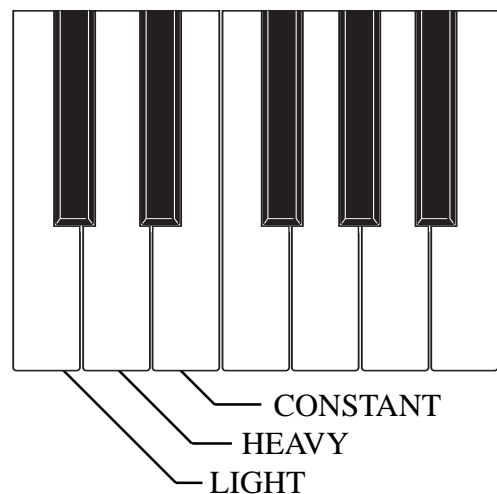

2. TUNING

This function allows you to adjust the piano's pitch to match recordings or other instruments in an ensemble.

(1) To lower the pitch press any C-sharp key while holding down the TOUCH and TRANSPOSE buttons. To raise the pitch press any E-flat key while holding down the TOUCH and TRANSPOSE buttons.

(2) Release the both hands after finding the desired pitch.

The range of tuning is +/-50 cents (100 cents = a half tone). Each press of the key will change the tuning 1.56 cents. Press the key repeatedly until you arrive at the desired pitch.

3. MIDI CHANNEL SELECT

In order to exchange MIDI information with a another MIDI instrument, you must first set the two connected instruments to the same channel.

(1) If you press any A key while holding down the TOUCH and TRANSPOSE buttons, the MIDI channel will increase by one each time you press the key. MIDI channel will progress from 1 to 16 and automatically cycle back to channel 1. If you press any G key, the channel will be set to 1 regardless of what channel is currently selected. And, if you press any F key while holding down the TOUCH and TRANSPOSE buttons, the MIDI channel will decrease by 1 each time you press the key.

(2) Release the both hands after selecting the channel.

When the power is first turned on, the PN81 always selects channel 1.

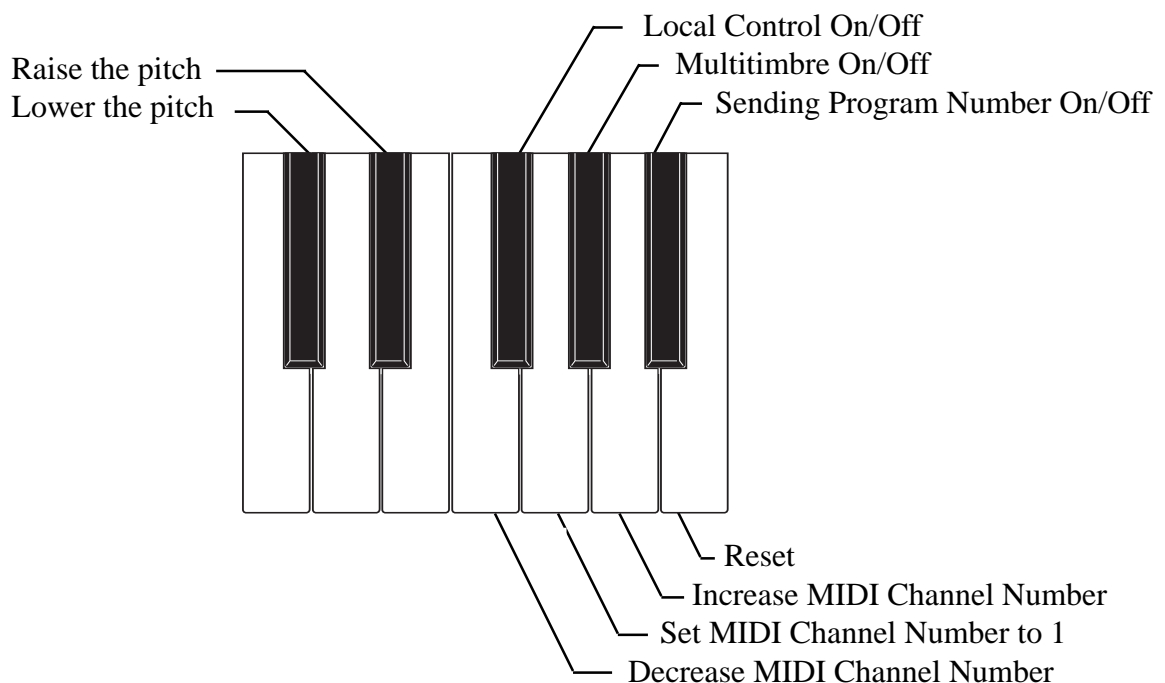

4. TURNING SENDING PROGRAM NUMBER ON AND OFF

You can use 8 tone buttons to transmit Program Number via MIDI. Pressing PIANO 1 button transmits Number 0, PIANO 2 for Number 1, E.PIANO for Number 2, CHURCH ORGAN for Number 5, HARPSICHORD for Number 11, VIBRAPHONE for Number 6, STRINGS for Number 7, CHOIR for Number 12.

(1) If you press any B-flat key while holding down the TOUCH and TRANSPOSE buttons, this function is set to “off” and the PN81 does not transmit the data corresponding to the tone selected on the panel. If you press the B-flat key again while holding down the TOUCH and TRANSPOSE buttons, this function returns to “on” and you can select the tone to transmit as data.

(2) Release both hands after selecting either “on” or “off” of sending program number. When the power is first turned on, the SENDING MIDI PROGRAM NUMBER is always “on”.

5. TURNING MULTITIMBRE ON AND OFF

Normally, the procedure described in the MIDI CHANNEL SELECT section is used to transmit or receive data on only one MIDI channel (any one of 1 through 16). But by turning the MULTI TIMBRE function “on”, you can receive more than one MIDI channel and simultaneously play a different timbre on each channel. With this feature, you can use a sequencer such as the Kawai DRP-10 to create performances with contain a variety of timbres on the digital piano. The term “Multi Timbre” is derived from this ability to play multiple timbre simultaneously.

(1) If you press any A-flat key while holding down the TOUCH and TRANSPOSE buttons, the MIDI MULTITIMBRE will be set to “on”. If you press any A-flat key again while holding down the TOUCH and TRANSPOSE buttons, the MIDI MULTITIMBRE function returns to “off”.

(2) Release both hands after selecting the desired setting. When power is first turned on, the MIDI MULTITIMBRE setting is always off.

CHANNEL	TONE COLOR	CHANNEL	TONE COLOR
1	PIANO 1	9	
2	PIANO 2	10	
3	E. PIANO	11	
4		12	STRINGS
5		13	CHOIR
6	CHURCH ORGAN	14	
7	HARPSICHORD	15	
8	VIBRAPHONE	16	

6. LOCAL CONTROL ON AND OFF

This mode is used to control whether or not the sound from the piano's keyboard will be heard.

(1) If you press any F-sharp key while holding down the TOUCH and TRANSPOSE buttons, the MIDI LOCAL CONTROL will be set to "off". If you press again any F-sharp key while holding down the TOUCH and TRANSPOSE buttons, the MIDI LOCAL CONTROL returns to "on".

(2) Release both hands after selecting the desired setting.

7. RESET

When the RESET procedure is used, most of the PN81's original factory settings will be restored. The original factory settings restored with this function are:

- MIDI Transmit Channel Channel 1
- MIDI Program Change On
- MIDI Multitimbre Off
- MIDI Local Control On
- Tuning +/-0
- Touch Type (When the TOUCH LED is flashing) LIGHT
- Tempo (Metronome of the Recorder) 120/min.

(1) Press any B-key while holding down the TOUCH and TRANSPOSE buttons.

(2) Release both hands after following this procedure.

MIDI

The term MIDI is an acronym for Musical Instrument Digital Interface, an international standard for connecting synthesizers, sequencers (digital recorders) and other electronic instruments so that they can exchange performance data.

The PN81 is equipped with two MIDI jacks for exchanging data: MIDI IN and MIDI OUT. Each uses a special cable with a DIN connector.

MIDI IN : For receiving note, program change and other data.

MIDI OUT : For sending note, program change and other data.

MIDI EXAMPLES

(1) Connection to another MIDI compatible keyboard or sound generator module

When connected as shown in the illustration, data on how the digital piano is played (which keys are struck) can be sent to another MIDI instrument. Plus, the sound from the PN81 can be layered over the sound of the other instrument.

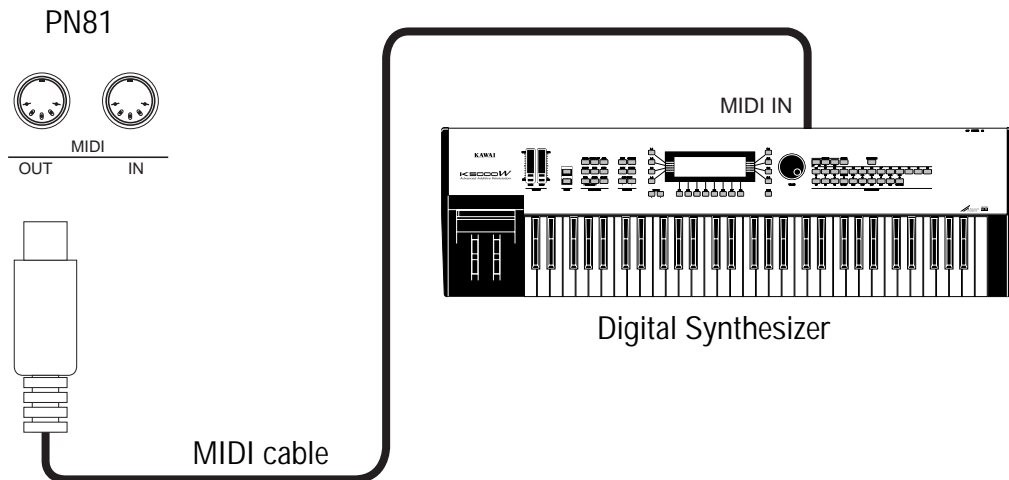

Layering Sounds

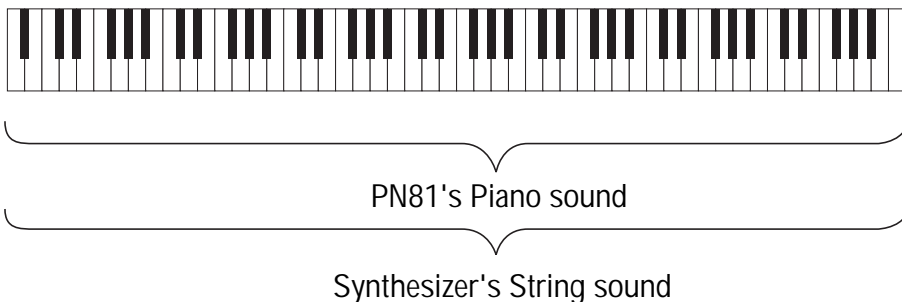

(2) Connection to an external sequencer and sound generator module

When connected as shown in the illustration, you can record songs played on the PN81 with a sequencer, and use the PN81's various tones (such as piano, harpsichord and vibraphone, etc.) controlled by the PN81's MULTI TIMBRE function to create a multi-layer MIDI recording. In case you use the KAWAI DRP-10, it also has some internal tones that you can play from the keyboard of the PN81.

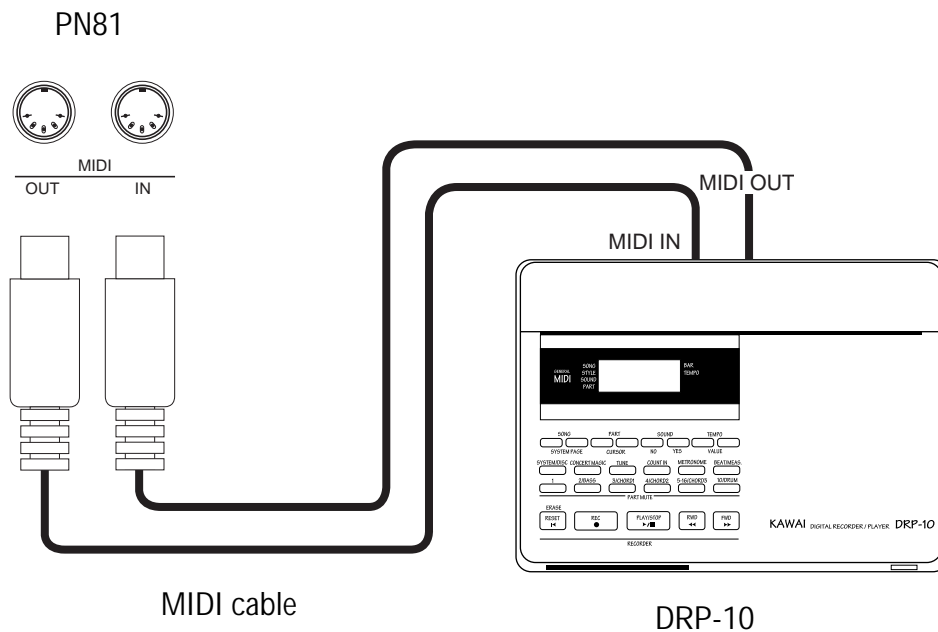

NOTE:

If using a sequencer or sound module and putting it on the top of the PN81, you should remove the fallboard.

- (1) Open the fallboard and you see the pivot with the spring down the right side of the board.
- (2) Slide the lever of the pivot inside and hold it. Then lift the fallboard up and take it off.

SPECIFICATIONS

KEYBOARD	88 Keys
TOUCH TYPES	4 Types (Normal, Light, Heavy, Constant)
MAX. POLYPHONY	24 Notes
TONES	8 Tones (PIANO1, PIANO2, E.PIANO, CHURCH ORGAN, HARPSICHORD, VIBRAPHONE, STRINGS, CHOIR)
EFFECTS	Reverb, Wide, Chorus
DIGITAL RECORDER	3-Song, 2-Track, 1,200-Notes
OTHER FUNCTIONS	Transpose, Tuning, MIDI Functions
DEMONSTRATION SONGS	12
PEDALS	2 (Soft, Sustain)
JACKS	Headphones x 2, Pedal, MIDI (IN, OUT), LINE IN(L, R), LINE OUT (L, R), DC In
SPEAKERS	12 cm x 2 (4 3/4"), 7W x 2
DIMENSIONS	137 x 45 x 79 (cm) 54" x 17 1/2" x 31 1/8"
WEIGHT	39 kg (85 lbs.)
POWER	AC Adaptor (12V 2A)

Specifications are subject to change without notice.

MIDI IMPLEMENTATION CHART

KAWAI DIGITAL PIANO
MODEL: PN81

Date: August, 1998
Version: 1.0

FUNCTION	TRANSMITTED	RECEIVED	REMARKS
Basic Channel (Default) (Changed)	1 1-16	1 1-16	
Mode (Default) (Message) (Altered)	3 X *****	1 1,3 X	
Note Number (True Voice)	15-113* *****	0-127 0-127	
Velocity (Note ON) (Note OFF)	○: 9nH v=1-127 X: 8nH v=0	○ X	
After Touch Key's Channel's	X X	X X	
Pitch Bend	X	X	
Control Change 7 64 67	X ○ (Right pedal) ○ (Left pedal)	○ ○ ○	Volume Damper pedal Soft pedal
Program Change True	○ *****	○	
System Exclusive	○	○	
Common (Song Position) (Song Select) (Tune)	X X X	X X X	
System: Real Time (Clock) (Commands)	X X	X X	
Others (Local ON/OFF) (All Notes OFF) (Active Sense) (Reset)	X X ○ X	○ ○ ○ X	

Notes: *Value varies when transposed. 21-108 when not transposed.

Mode 1: OMNI ON, POLY Mode 2: OMNI ON, MONO
Mode 3: OMNI OFF, POLY Mode 4: OMNI OFF, MONO

