

**KAWAI**

*Digital  
Piano*

**MR3000**

*Owner's Manual*

**WARNING:** This equipment generates, uses, and can radiate radio frequency energy. If not installed and used in accordance with the instruction manual, it can cause interference to radio communications. The rules with which it must comply afford reasonable protection against interference when used in most locations. However, there can be no guarantee that such interference will not occur in a particular installation. If this equipment does not cause interference to radio or the equipment off and on, the user is encouraged to try correct the interference by one or more of the following measures:

- reorient the receiving antenna.
- move the receiver away from the digital piano.
- plug the digital piano into a different outlet so that digital piano and receiver are on different branch circuits.
- consult the dealer or an experienced radio television technician.

This digital piano should be not commercial use but household use.

# IMPORTANT SAFETY INSTRUCTIONS

**WARNING** – When using electric products, basic precautions should always be followed, including the following:

1. Read all the instructions before using the product.
2. To reduce the risk of injury, close supervision is necessary when a product is used near children.
3. Do not use this product near water – for example, near a bathtub, washbowl, kitchen sink, in a wet basement, or near a swimming pool, or the like.
4. Do not touch the power plug with wet hands. There is a risk of electrical shock. Treat the power cord with care as well. Stepping on or tripping over it can break or short-circuit the wire inside.
5. This product should be used only with a cart or stand that is recommended by the manufacturer.
6. This product, either alone or in combination with an amplifier and headphones or speakers, may be capable of producing sound levels that could cause permanent hearing loss. Do not operate for a long period of time at a high volume level or at a level that is uncomfortable. If you experience any hearing loss or ringing in the ears, you should consult an audiologist.
7. The product should be located so that its location or position does not interfere with its proper ventilation.
8. The product should be located away from heat sources such as radiators, heat registers, or other products that produce heat.
9. Keep the instrument away from electrical motors, neon signs, fluorescent light fixtures, and other sources of electrical noise.
10. The product should be connected to a power supply only of the type described in the operating instructions or as marked on the product.
11. This product may be equipped with a polarized line plug (one blade wider than the other). This is a safety feature. If you are unable to insert the plug into the outlet, contact an electrician to replace your obsolete outlet. Do not defeat the safety purpose of the plug.
12. Always turn the power off when the instrument is not in use. The power-supply cord of the product should be unplugged from the outlet when left unused for a long period of time.
13. Care should be taken so that objects do not fall and liquids are not spilled into the enclosure through openings.
14. The product should be serviced by qualified service personnel when:
  - A. The power-supply cord or the plug has been damaged; or
  - B. Objects have fallen, or liquid has been spilled into the product; or
  - C. The product has been exposed to rain; or
  - D. The product does not appear to operate normally or exhibits a marked change in performance; or
  - E. The product has been dropped, or the enclosure damaged.
15. Do not attempt to service the product beyond that described in the user-maintenance instructions. All other servicing should be referred to qualified service personnel.

## SAVE THESE INSTRUCTIONS



### CAUTION

RISK OF ELECTRIC SHOCK  
DO NOT OPEN



### WARNING

TO REDUCE THE RISK  
OF FIRE OR ELECTRIC  
SHOCK. DO NOT EXPOSE  
THIS PRODUCT TO  
RAIN OR MOISTURE.

**AVIS: RISQUE DE CHOC ELECTRIQUE**

-NE PAS OUVRIR.

**CAUTION:** TO REDUCE THE RISK OF ELECTRIC SHOCK, DO NOT REMOVE COVER (OR BACK). NO USER-SERVICEABLE PARTS INSIDE. REFER SERVICING TO QUALIFIED SERVICE PERSONNEL.



The lightning flash with arrowhead symbol, within an equilateral triangle, is intended to alert the user to the presence of uninsulated "dangerous voltage" within the product's enclosure that may be of sufficient magnitude to constitute a risk of electric shock to persons.



The exclamation point within an equilateral triangle is intended to alert the user to the presence of important operating and maintenance (servicing) instructions in the literature accompanying the product.

## Thank you for purchasing a KAWAI Digital Piano!

The Kawai digital piano MR3000 is a revolutionary new keyboard instrument that combines the latest in electronic advances with traditional craftsmanship inherited from Kawai's many years of experience in building fine pianos. Its wooden keys provide the touch response and full dynamic range required for a superb performance on the piano, harpsichord, organ, and other instrument presets. Moreover, the newly-added reverb effect gives you even deeper resonance. Industry-Standard MIDI (Musical Instrument Digital Interface) jacks are included which allow you to play other electronic instruments at the same time - opening a whole new world of musical possibilities. This Owner's Manual contains valuable information that will help you make full use of this instrument's many capabilities. Read it carefully and keep it handy for further reference.

## Table of Contents

■ Basic Controls .....	1
■ Let's Play .....	4
1) Basic Operation .....	4
2) DUAL and SPLIT .....	5
■ Advanced Features.....	7
1) Programming Mode.....	7
2) Changing the SPLIT Point .....	8
3) Tuning.....	9
4) Temperaments .....	10
■ MIDI Interface .....	12
1) What's MIDI? .....	12
2) Connections.....	13
3) MIDI Implementation .....	15
4) MIDI Operation .....	16
(A) Setting the channel .....	16
(B) Sending a program number .....	17
(C) Turning MULTI TIMBRE on and off .....	20
(D) LOCAL CONTROL.....	21
■ Specifications .....	23
■ MIDI Implementation Chart .....	24

# Basic Controls

## Front Panel

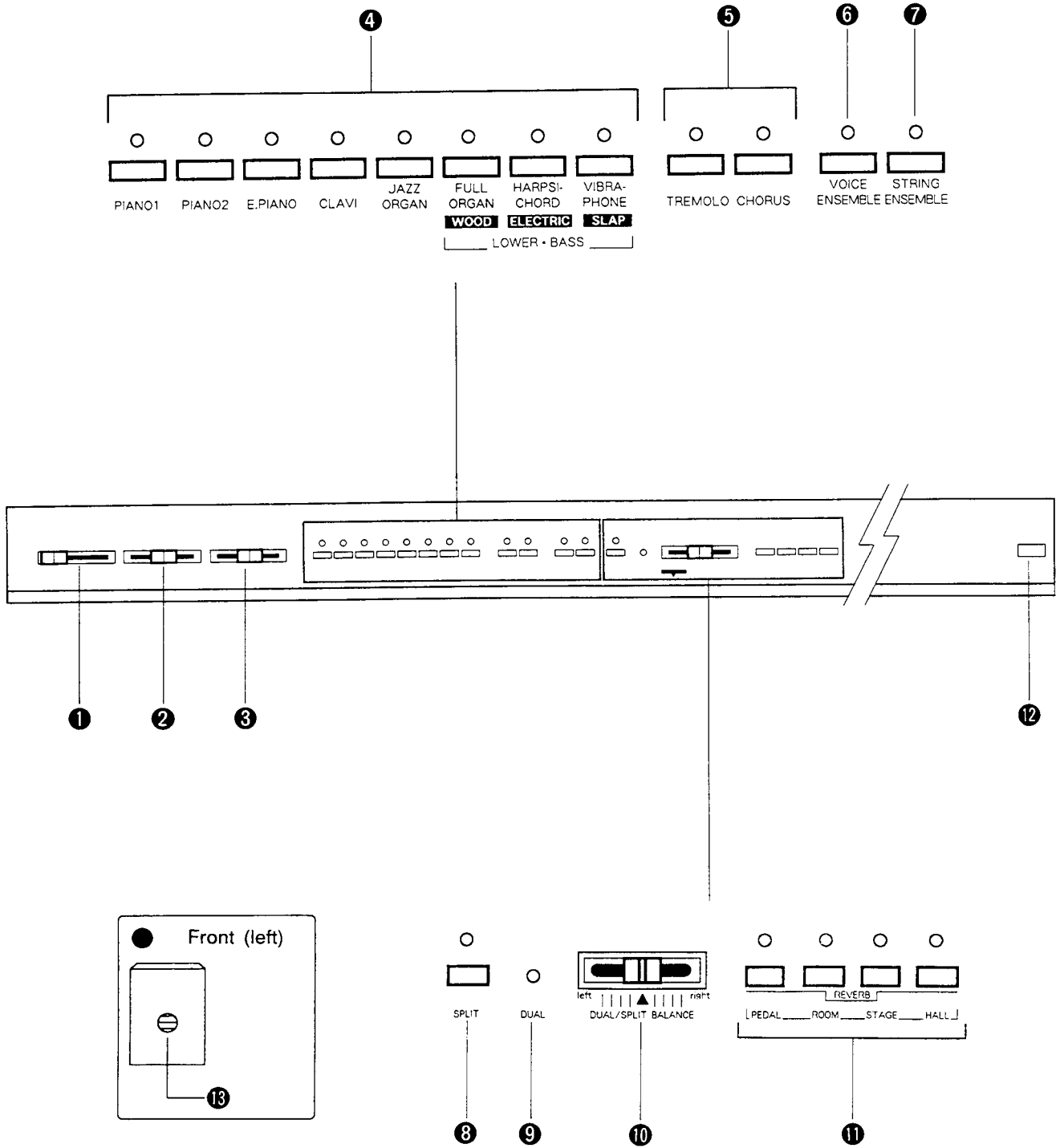

---

## ❶ VOLUME

Move the volume slider to the right to increase the instrument's volume.

Move the slider to the left to decrease the volume.

## ❷ BRILLIANCE control

This slider controls the brilliance, or clarity, of the sound. Shifting it to the left produces a rich, mellow sound; shifting it to the right, a bright, clear sound. The center position corresponds to the instrument's normal tone.

## ❸ TRANSPOSE control

Shifting the slider to the right raises the piano's key (C – C# – D – Eb – E – F).

Shifting it to the left lowers the key (C – B – Bb – A – Ab – G – F#).

You can therefore play the music as written - in C major, for example – and have the instrument transpose the output to a higher or lower key to match your voice.

## ❹ TONE SELECTORS

Select the desired instrument by pressing the appropriate switch.

**•Note:** The WOOD BASS, ELECTRIC BASS, and SLAP BASS are only available for the lower part of a SPLIT keyboard. (See p. 5.)

## ❺ EFFECTS

These functions cause the output to become more animated (CHORUS) or fluctuate (TREMOLLO).

## ❻ VOICE ENSEMBLE

Same as the TONE SELECTORS. This is used to produce voice ensemble sounds.

## ❼ STRING ENSEMBLE

Same as the TONE SELECTORS. This is used to produce string ensemble sounds.

**•Note:** The CHORUS effect is not available with 6 VOICE ENSEMBLE or 7 STRING ENSEMBLE tones.

## ❽ SPLIT switch

Pressing this switch splits the keyboard into an upper and lower half, each with different tone colors. When the function is first activated, the keyboard is split at the point marked on the front panel, but this point is changeable. (For the procedure, see p. 8.)

## ❾ DUAL LED

Simultaneously pressing two tone selector switches lights this DUAL LED and activates the DUAL mode of operation, in which the piano simultaneously uses two tones instead of just one.

Press a single switch to cancel.

## ❿ DUAL/SPLIT BALANCE control

This slider controls the relative loudness of the two voices used in the SPLIT and DUAL modes. Shifting it to the right in the SPLIT mode makes the UPPER keyboard louder. For the DUAL mode, it is the rightmost preset of the pair that becomes louder.

### • Example

The PIANO1 selector is to the left of VIBRAPHONE. If they are being used together in the DUAL mode, shifting the slider to the left makes the PIANO1 tone louder.

Shifting it to the right makes the VIBRAPHONE tone louder.

## ⓫ REVERB switches

This adds a REVERB (echo) effect to the sound for greater beauty.

## ⓬ POWER

This switch turns the instrument on and off. Be sure to turn off the instrument when finished playing.

## ⓭ HEADPHONE jack

This jack is for headphones sold separately (SH-5 or SH-2).

## ■ Rear Panel

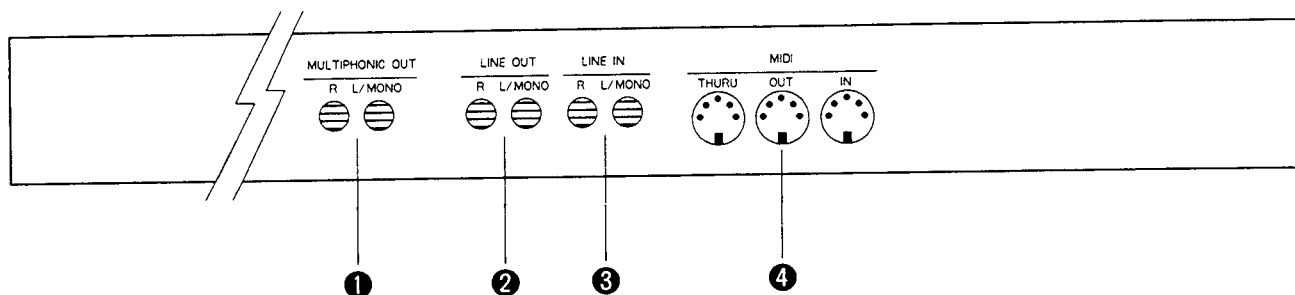

### ❶ MULTIPHONIC OUT

These jacks are for connecting speakers with built-in amplifiers such as the KM-20, allowing you to enjoy a wider range of sound than can be obtained with only the speakers built into the digital piano. Use the L/MONO jack when using only one output.

**•Note:** These outputs will be valid only when you select one of the REVERB switches (except "PEDAL") on.

These outputs bypass the piano's VOLUME control.

You cannot mute sounds from these outputs even when connecting a headphone to the HEADPHONE jack.

### ❷ LINE OUT

These jacks provide stereo output to amplifiers, stereo systems, tape recorders, or similar equipment. Use the L/MONO jack when using only one output.

### ❸ LINE IN

These jacks connect two channels of output from other electronic instruments to the piano's speaker. Use the L/MONO jack when using only one input.

**•Note:** This input bypasses the piano's VOLUME control.

To adjust the balance, you must use the output volume controls on the individual instruments.

### ❹ MIDI

These jacks allow communication with other gear equipped with MIDI.

#### • The pedals

From right to left, the three pedals are the damper pedal, the sostenuto pedal, and the soft pedal.

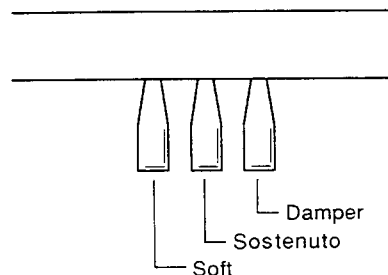

**Damper pedal:** Pressing this pedal sustains the sound even after removing the hands from the keyboard.

**Sostenuto pedal:** depressing this pedal after pressing the keyboard and before releasing the keys sustains the sound of only the keys just played.

**Soft pedal:** Pressing this pedal softens the sound, and also reduces its volume.

#### • Sliding key cover

Do not place heavy objects on the sliding key cover or subject it to severe shocks. Also, the sliding key cover should be opened and closed gently, using both hands.

# ■ Let's Play

## 1) Basic Operation

---

### • Procedure

#### (1) Turn on the power.



#### (2) Adjust the volume.



Sound a note on the keyboard and adjust the volume. (Moving the slider to the right raises the volume; moving it to the left lowers it.)

#### (3) Choose the timbre.

Pressing a tone selector switch automatically changes the tone of the piano. The LED next to it lights to indicate which tone is currently in effect.

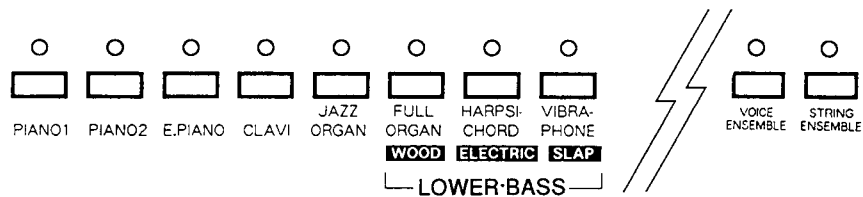

#### (4) Play.

Experiment with the various tone colors to acquaint yourself with the sounds that are available.

**•Note:** Sounds for up to 15 keys can be played when many keys are pressed simultaneously (15 note polyphonic).

#### (5) Add the effect.

Press an effect switch to add a special effect (CHORUS and TREMOLO).

#### (6) Add the REVERB.

Four REVERB effects are available.

**PEDAL:** A REVERB effect is added when the damper pedal is depressed, further heightening the effect of this pedal.

**ROOM:** Gives a soft REVERB effect simulating play in a room.

**STAGE:** Gives a REVERB effect simulating play on stage.

**HALL:** Gives a deep REVERB effect simulating play in a hall.

\* These effects may be absent or altered depending on the timbre used.



## 2) DUAL and SPLIT

---

The MR3000 has DUAL and SPLIT modes which allow you to combine two timbres.

**DUAL MODE:** You can combine two timbres in a layer with this mode, creating sounds and effects impossible with just a single timbre.

**SPLIT MODE:** In this mode it is possible to divide the keyboard at the SPLIT POINT into upper and lower halves, each with a different timbre, for ensemble play.

### A) DUAL operation

- **Procedure**

- (1) Simultaneously press two tone selector switches to achieve tone colors at once and light the DUAL LED.



DUAL

- **Note:** • Pressing such a combination also halves the number of simultaneous voices available to seven (7 note polyphonic).
- Pressing another pair changes the combination.
- To cancel and return to normal operation, press a single tone selector switch.

### B) SPLIT operation

This operation splits the keyboard into an upper and lower half with different tone colors. The LED for the UPPER keyboard timbre glows continuously; the one for the LOWER keyboard flashes.

- **Procedure**

- (1) Press the SPLIT switch so that the LED next to it lights.



SPLIT

- (2) Press a tone selector to change the UPPER timbre.
- (3) Hold down the SPLIT switch and press a tone selector to change the LOWER timbre.
- (4) Adjust the relative loudness of the two tone colors with the DUAL/SPLIT BALANCE control.

- 
- Note:**
- When the function is first activated, the keyboard is split at the point marked with a triangle on the front panel, and LOWER keyboard assumes the WOOD BASS timbre.
  - The FULL ORGAN, HARPSICHORD and VIBRAPHONE cannot be selected as lower tone colors. Conversely, the WOOD BASS, ELECTRIC BASS and SLAP BASS cannot be selected as upper tone colors.
  - The LOWER timbre specification remains in effect until the power is removed or the timbre is changed.
  - Switching from DUAL operation to SPLIT operation makes the UPPER keyboard assume the right timbre and the LOWER assume the WOOD BASS or the tone you chose for the LOWER timbre.
  - You must turn the SPLIT operation off before you can return to DUAL operation.
  - To change the SPLIT point, see p. 8 "Changing the SPLIT Point".

# ■ Advanced Features

## 1) Programming Mode

The programming mode allows you to change the keyboard's SPLIT point, tuning, and temperament, and utilize the various MIDI capabilities. These programming functions are performed using the panel switches and keyboard, so please try them after reading and understanding the programming instructions completely.

### A. Entering the programming mode

- (1) Press the CHORUS switch.
- (2) Holding down the CHORUS switch, press the first three tone selector switches (PIANO1, PIANO2 and E.PIANO).

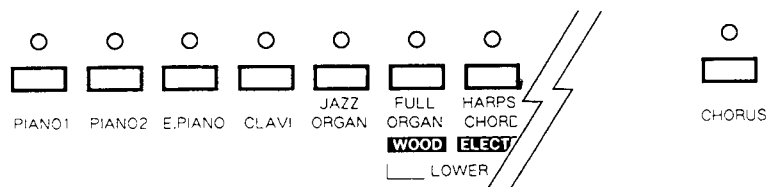

- (3) The LEDs next to the CHORUS and PIANO1 switches should then start flashing to indicate that the piano is in the programming mode. In this mode, striking the keyboard produces no sound.
- (4) Press a tone color switch or SPLIT switch to select the desired programming mode.

The correspondence between switches and 7 types of programming mode is as below:

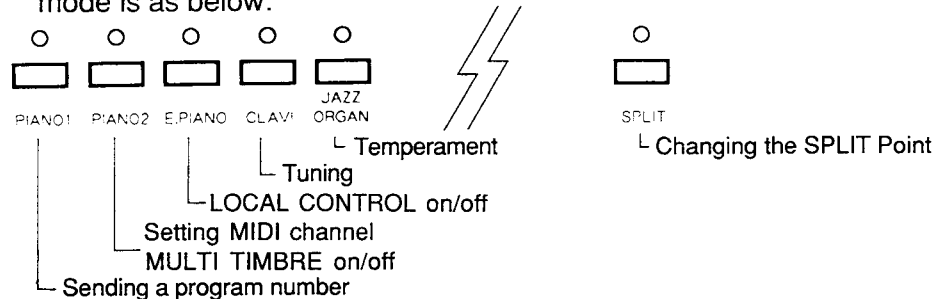

### B. Leaving the programming mode

- (1) Press the CHORUS switch.
- (2) The flashing will stop, and you will return to the timbre in effect when you entered the programming mode.

**•Note:** You can also continue into another programming mode by pressing another TONE SELECTOR without pressing the CHORUS switch.

## 2) Changing the SPLIT Point

---

- **Procedure**

- (1) Make sure that the piano is in the programming mode.
- (2) Press the SPLIT switch so that it flashes to indicate that the piano is waiting for a SPLIT point specification.



- (3) Press the key corresponding to the lowest note for the desired UPPER range. For example, pressing the lowest key on the keyboard makes UPPER the entire keyboard.
- (4) Leave the programming mode.

## 3) Tuning

---

- **Procedure**

- (1) Make sure that the piano is in the programming mode.
- (2) Press the CLAVI switch so that it flashes to indicate that the piano is ready to be tuned.



- (3) Unlike the other functions in the programming mode, this one produces sound so that you can compare the piano's pitch with another instrument.

**•Note:** Playing the keyboard when set up this way produces the timbre selected before entering the programming mode. Tuning is done using this timbre. If you want to change the timbre, leave the programming mode (see p. 7), select the new timbre, and repeat steps (1) and (2).

- (4) Press the highest black key to lower the pitch.  
Or press the highest white one to raise it.  
It may be necessary to press these key repeatedly to achieve proper tuning.

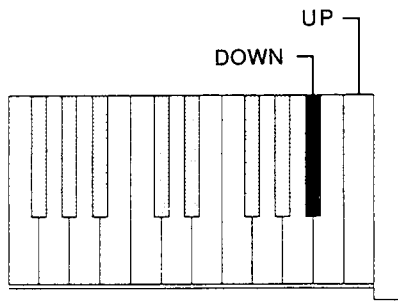

- (5) Leave the programming mode.

**•Note:** Momentarily turning off the power restores the original pitch.

## 4) Temperaments

---

Your Kawai digital piano offers not only equal temperament (the modern standard) but also immediate access to those popular during the Renaissance and Baroque period.

### •Procedure

- (1) Make sure that the piano is in the programming mode.
- (2) Press the JAZZ ORGAN switch so that it flashes to indicate that the piano is waiting for a temperament specification.
- (3) Press one of the seven white keys at the lower end of the keyboard to select one of these corresponding temperaments.

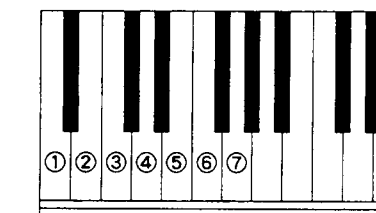

1. Equal temperament without the tuning curve
2. Mersenne pure temperament
3. Pythagorean temperament
4. Meantone temperament
5. Werckmeister III temperament
6. Kirnberger III temperament
7. Equal temperament with the tuning curve

- (4) Leave the programming mode.

**•Note:** When the power is first applied or reapplied after a short break, the piano returns to the modern standard (equal temperament with the tuning curve = #7).

Key set function is also available at this point. As you know, limitless modulation of the key became available only after the invention of Equal temperament. When we use a temperament except Equal temperament, we must carefully choose the key signature to play in. To select the key signature setting, simply press one of the key. For example, if the tune you are going to play is written in D major, press D key to set the keys.

Please note that this will only change the "balance" of the tuning, and the pitch of the keyboard will remain unchanged. Use the TRANSPOSE control to change the pitch of the whole keyboard.

---

## ■ Temperament characteristic

- **Equal temperament**

This, by far the most popular piano temperament, divides the scale into twelve equal semitones and has the advantage of producing the same chords for all transportation.

- **Mersenne temperament**

This temperament, which eliminates consonances for thirds and fifth, is still popular for choral music.

- **Pythagorean temperament**

This temperament, which uses mathematical ratios to eliminate consonances for fifth, has problems with chords, but produces a very beautiful melodic lines.

- **Meantone temperaments**

This temperament, which uses a mean between a major and minor whole tone to eliminate consonances for thirds, was devised to eliminate the lack of consonances experienced with certain fifth for the Mersenne pure temperament. It produces chords that are more beautiful than those with the equal temperament.

- **Werckmeister III temperament, Kirnberger III temperament**

For key signature with accidentals, this temperament produces the beautiful chords of the mean tone, but, as the accidentals increase, the tension increases, and the temperament produces the beautiful melodies of the Pythagorean temperament. It is used primarily for classical music written to take advantage of these characteristics.

# ■ MIDI Interface

## 1) What's MIDI?

---

Before attempting to set the MIDI function, let's take a brief look at what MIDI is.

The letters MIDI stand for Musical Instrument Digital Interface, an international standard for connecting synthesizers, drum machines, and other electronic instruments so that they can exchange performance data.

Instruments equipped with MIDI have three jacks for exchanging data: IN, OUT, and THRU. Each uses a special cable with a DIN connector for connection (see p. 13).

IN: For receiving keyboard, timbre, and other data.

OUT: For sending keyboard, timbre, and other data.

THRU: For sending received data to another instrument without processing.

Electrical and electronic musical instruments equipped with MIDI are able to transmit and receive performance data such as for keyboard and timbre.

Depending on the connection method, instruments are grouped as those which receive data (producing sound according to data received from the connected instrument), those which send data (to the instruments to which they are connected), and those which both send and receive data.

The cable is connected to the MIDI IN jack of the instrument receiving data and to the OUT jack of the sending instrument. The THRU jack is used when the data received is to be sent to another instrument.

MIDI uses what are known as "channels" as a means of transmitting data for playing a specified instrument.

There are two types of channels, one for receiving and one for sending, and MIDI instruments are normally equipped with both types. Receive channels are used when an instrument receives data from another instrument, and send channels are used for transmission to another instrument.

For instance, let's say that three instruments are connected for playing in this way:

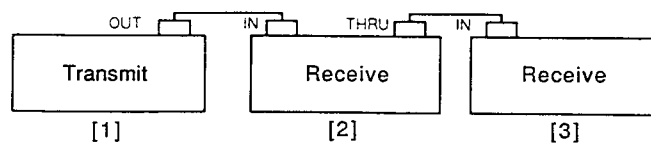

Instrument [1], which is sending, transmits the send channel along with keyboard and other data to instruments [2] and [3], which are receiving. This data is sent to instruments [2] and [3], but the data will not be received unless the receive channel for these two instruments matches the send channel used by instrument [1].

There are 16 channels each (1 through 16) available for both sending and receiving.



## 2) Connections

**(1) Connection to another MIDI-compatible keyboard**  
(connection with instruments such as the Kawai digital synthesizer K1II or K5)

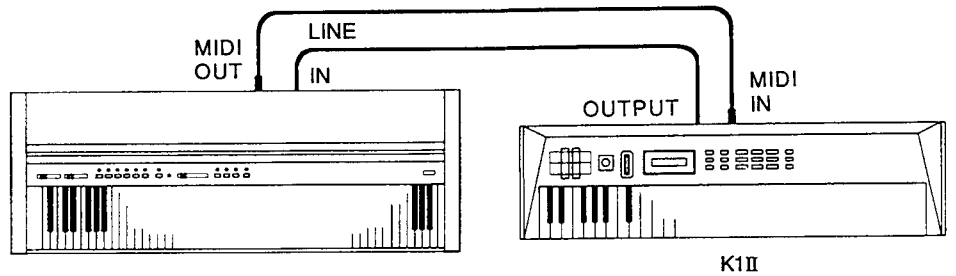

When connected as shown in the illustration, data on how the digital piano is played (what keys are struck and how hard) is sent to the synthesizer unchanged. Also, by connecting the synthesizer's OUTPUT jack and the LINE IN jack on the digital piano, the sound from the digital piano can be layered over the sound of the synthesizer. Since timbre can be set separately, you can assembly a wide variety of sound combinations, such as a PIANO tone from the digital piano layered with a STRING tone from the synthesizer for a thick sound.

**(2) Connection to a drum machine**  
(connection with instruments such as the Kawai R-50e/R-100)

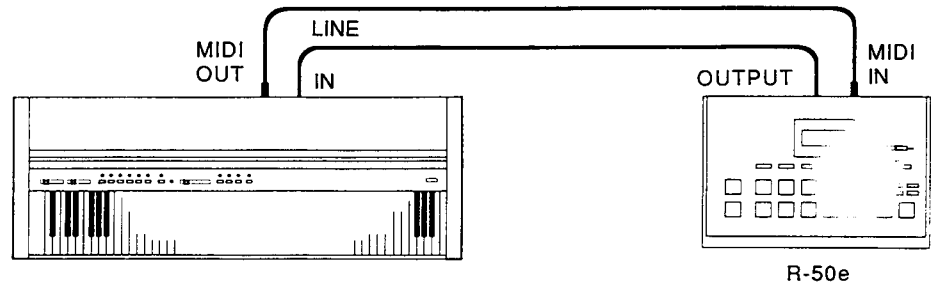

When connected as shown in the illustration, you can not only play along with the rhythm from the R-50e, you can also play the R-50e by striking the keys on the digital piano.

**(3) Connection to a sound generator module**  
(connection with instruments such as the Kawai K1r/PHm)

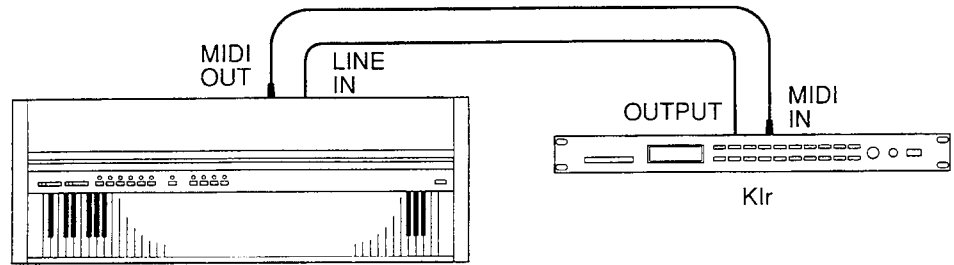

When connected as shown in the illustration, you can layer sounds like (1) as well as playing a large number of tones using the MR3000's SPLIT keyboard function.

**(4) Connection to a sequencer and sound generator module**  
(connection with instruments such as the Kawai Q-50/PHm)

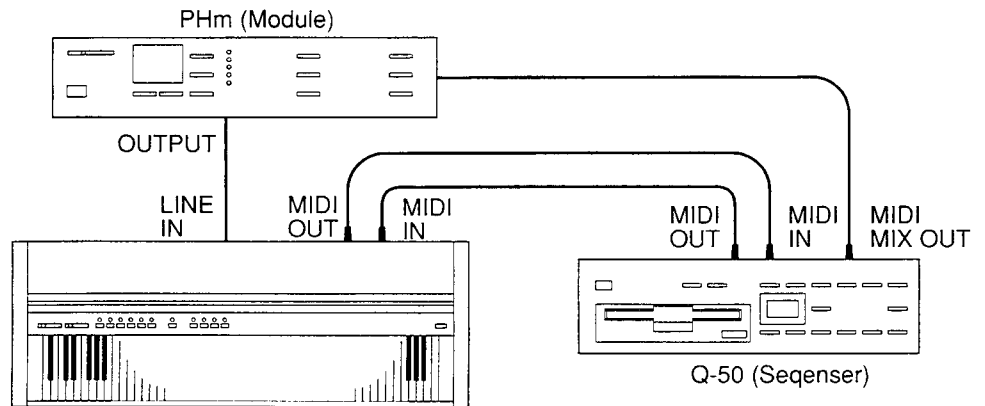

When connected as shown in the illustration, you can record songs played on the piano with the sequencer and play them back as many times as you like, and layer the module's tones made with the piano's MULTI TIMBRE function to assemble a complex automatic performance.

# 3) MIDI Implementation

---

The MIDI interface on your Kawai Digital Piano allows you to:

1. Receive and transmit keyboard data.

You can play the digital piano to output sound on a synthesizer or other instrument, or vice versa.

2. Set channel numbers for sending and receiving.

You can set send or receive channels to any number from 1 to 16.

3. Receive and transmit program numbers (codes for changing timbres)

You can operate the digital piano to change the programmed timbre of a synthesizer or other instrument connected with the MIDI interface to the piano, or vice versa (see p. 17).

4. Receive and transmit pedal data.

You can receive and transmit ON/OFF data for the soft and damper pedals.

5. Receive volume data.

You can control the volume of the digital piano from an external source connected via the MIDI interface.

6. Set MULTI TIMBRE.

When the digital piano is used as a receiving instrument, you can receive keyboard data on a number of different channels, producing different timbres for each one.

**\* For details of the MIDI function of this instrument, please refer to the MIDI Implementation Chart.**

## 4) MIDI Operation

### A. Setting the channel

In order to be able to exchange information with a connected MIDI instrument, you must first set the interconnected instruments to the same channel.

• **Procedure**

- (1) Make sure that the digital piano is in the programming mode.  
(See p. 7.)
- (2) Press the PIANO2 switch so that it flashes to indicate that the interface is waiting for a channel specification. (It is also possible to turn the MULTI TIMBRE function on and off. See following section.)



- (3) Select the channel by pressing the one of the first 16 white keys at the lower end of the keyboard.

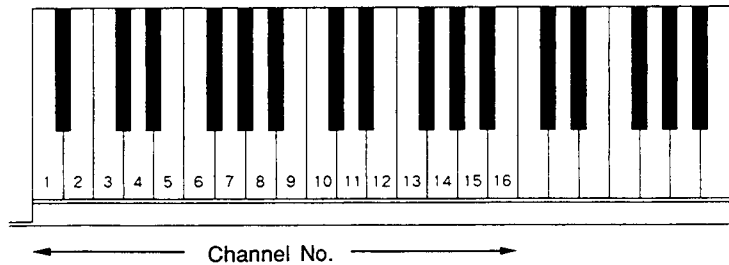

• **Note:** You have 16 channels to choose from.

- (4) Pressing one of these keys automatically sets the instrument's transmitting and receiving channel to the number selected.
- (5) Leave the programming mode. (See p. 7.)

• **Note:** When the power is first applied, the interface uses Channel 1 and has the OMNI parameter on. Changing to another channel automatically turns the OMNI parameter off. In OMNI mode, information from all channels is received.

---

## B. Sending a program number (timbre code)

### (a) Transmitting with the TONE SELECTORS

You can use the ten TONE SELECTORS during normal playing to transmit program numbers 0 through 9 shown in the chart below.

Tone Selector	Program No.
PIANO1	0
PIANO2	1
E.PIANO	2
CLAVI	3
JAZZ ORGAN	4
FULL ORGAN	5
HARPSICHORD	6
VIBRAPHONE	7
VOICE ENSEMBLE	8
STRING ENSEMBLE	9

Transmission with these TONE SELECTORS can be switched on and off as described below.

(1) Enter the programming mode (see p. 7).

The LEDs for CHORUS and PIANO1 will flash. The flashing of the PIANO1 LED shows that the instrument is in the programming mode for transmitting the program number, so move on to the next step.

**\* No sound will be played if the keyboard is pressed at this time.**

(2) Press the highest black or white key.

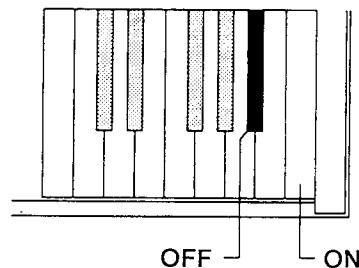

Pressing a black key (OFF) disables transmission by the TONE SELECTORS.

Pressing a white key (ON) enables transmission.

(3) Press the CHORUS switch to leave the programming mode. You may then change to another programming mode.

- \* The setting described above is automatically set on when the power is turned on, so you can also turn the setting simply by turning the power off and then on again, instead of using the procedure described above.
- \* If two TONE SELECTORS are pressed at the same time when in the DUAL mode, the program number for the timbre on the right will be transmitted.
- \* In the SPLIT mode, the program number corresponding to the higher timbre will be transmitted, and the program number for the lower timbre will not be sent. In the MULTI TIMBRE mode (see p. 20), however, the program number for the lower timbre will also be sent, on the channel one higher than the MIDI channel for the higher timbre.

#### (b) Using black keys

In addition to transmission with the TONE SELECTORS, you can also use the black keys on the instrument to send program numbers 0 through 127.

#### • Procedure

(1) Make sure that the digital piano is in the programming mode.  
(See p. 7)

The flashing LED next to the PIANO1 switch indicates that the interface is ready to transmit a program number.



PIANO1

(2) Select the program number by pressing the corresponding pair of black keys at the lower end of the keyboard. There are a total of 128 numbers possible: the first thirteen black keys give the first and second digits ("00" – "12") of this three-digit numbers; the next ten, the final digit ("0" – "9").

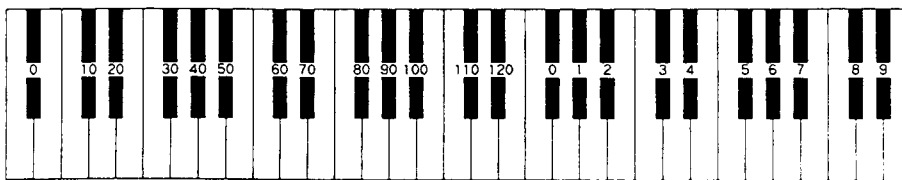

First two digits

Final digit

**Note:** You must press the two keys in order from left to right.

---

- **Example:**

- Program No. 3

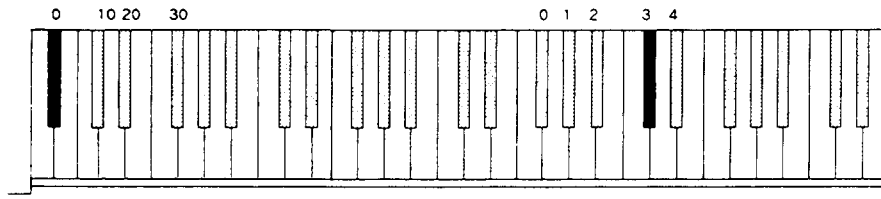

- Press the "00" key and then the "3" key.

- Program No. 20

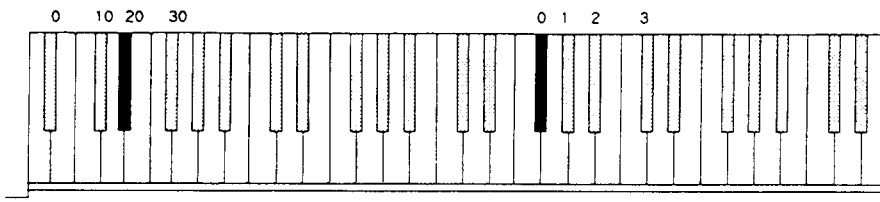

- Press the "20" key and then the "0" key.

- Program No. 42

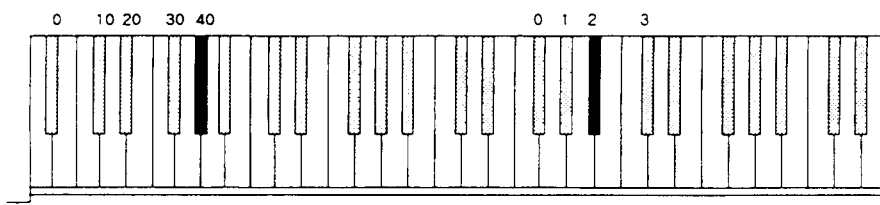

- Press the "40" key and then the "2" key.

**Note:** • When transmitting a program number that has the same tens digit as the number being sent (such as, for instance, transmitting 33 after sending 31), you don't need to press the tens digit. The number can be transmitted simply by pressing the ones digit.  
• The tens digit is set at "0\*" when the programming mode is entered.

(3) Leave the programming mode. (See p. 7.)

## C. Turning MULTI TIMBRE on and off

Normally, the procedure described above is used to transmit or receive data on a set MIDI channel (any one of 1 through 16), but by turning the MULTI TIMBRE function on you can receive more than one MIDI channel and simultaneously play a different type of timbre on each one. With this feature, you can use a sequencer such as the Kawai Q-80/ Q-50 to assemble performances with a number of timbres (MULTI TIMBRE) on the digital piano.

### • Procedure

- (1) Make sure that the digital piano is in the programming mode.  
(See p. 7.)
- (2) Press the PIANO2 switch to set the LED next to the PIANO2 switch flashing.

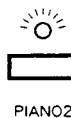

- (3) Press the highest black key to turn the function "off".  
Or press the highest white one to turn it "on".

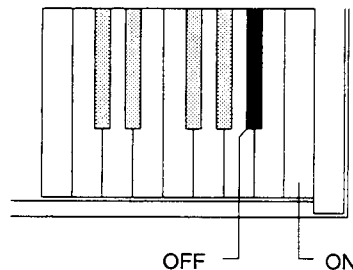

When MIDI data is received while the MULTI TIMBRE function is off, it will be played according to the TONE SELECTOR currently selected. When the MULTI TIMBRE mode is on, the received MIDI data will be played in the timbre corresponding to the MIDI channel shown in the chart below, regardless of the TONE SELECTOR currently in effect.

CHANNEL	TIMBRE	CHANNEL	
1	PIANO1	9	VOICE ENSEMBLE
2	PIANO2	10	(Empty)
3	E.PIANO	11	STRING ENSEMBLE
4	CLAVI	12*	PIPE ORGAN
5	JAZZ ORGAN	13*	BELL
6	FULL ORGAN	14	WOOD BASS
7	HARPSICHORD	15	ELECTRIC BASS
8	VIBRAPHONE	16	SLAP BASS



---

The timbres on the panel are allotted to Channels 1 through 9 and to 11, and the bass timbres enabled in the SPLIT mode are allotted to Channels 14 through 16. (Refer to "Local Control" below for the timbres for Channels 12 and 13.)

- \* The **MULTI TIMBRE** mode is off when the power is turned on.
- \* When the **MULTI TIMBRE** mode is on, the timbres for each receiving channel are played at full scale, even if the **SPLIT** mode is set. When transmitting, the higher timbre is set at the **MIDI** channel listed above, and the lower timbre is set at the next higher channel.

(4) Leave the programming mode. (See p. 7)

## D. LOCAL CONTROL

The PIPE ORGAN and BELL timbres allotted to Channels 12 and 13 cannot be chosen with the TONE SELECTORS on the panel. When you want to play in these timbres with the digital piano's keyboard (without using an externally connected MIDI instrument), you must first turn off the LOCAL CONTROL explained below.

- (1) Make sure that the piano is in the programming mode. After turning off the **MULTI TIMBRE** mode, press the E. PIANO switch. The flashing LED will change from PIANO2 to E. PIANO.

This mode is used to set whether the sound from the piano's keyboard will be played or not, and is called the LOCAL CONTROL ON/OFF mode. When set like this, no sound will be played when the keys are struck.

- (2) Press the highest white or black key to run LOCAL CONTROL on or off.

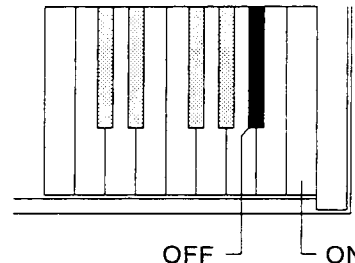

White key (ON): The piano will output sound when the keys are struck.  
Black key (OFF): Sound will be output only when MIDI data is received, and not when the keyboard is played.

- \* You can also turn this on by turning the power off and then on again, instead of using the highest key as described above.

- 
- (3) Press the PIANO1 switch to enter the CHANNEL SELECT mode, and select MIDI Channel 12 or 13 (see p. 16).
  - (4) Press the CHORUS switch to leave the programming mode.
  - (5) Connect a MIDI cable to both the MIDI IN and MIDI OUT jacks at the rear of the piano.

This procedure lets you play in the PIPE ORGAN and BELL timbres allotted to Channels 12 and 13 with the piano's own keyboard. Moreover, turning on LOCAL CONTROL as described in step (2) lets you play with the timbres of the TONE SELECTORS on the panel layered over.

# ■ Specifications

<b>Keyboard</b>	88 keys (wood)
<b>Tone Colors</b>	[Upper] Piano 1, 2, E. Piano, Clavi, Jazz Organ, Full Organ, Harpsichord, Vibraphone, Voice Ensemble, String Ensemble [Lower] Piano 1, 2, E. Piano, Clavi, Jazz Organ, Wood Bass, Electric Bass, Slap Bass, Voice Ensemble, String Ensemble
<b>Effects</b>	REVERB (PEDAL, ROOM, STAGE, HALL) Tremolo, Chorus
<b>Special Mode</b>	Dual, Split
<b>Temperaments</b>	Equal, Mersenne pure Pythagorean, Meantone Werckmeister III, Kirnberger III
<b>Controls</b>	Volume, Brilliance, Transpose, Tune Dual/Split Balance, Split Point
<b>Other Fittings</b>	Headphone Jack, Line In Jacks (L [Mono]/R), Line Out Jacks (L [Mono]/R), MIDI Jacks (IN, OUT, THRU), Multiphonic Out (L [Mono]/R)
<b>Output Power</b>	30W x 2
<b>Speakers</b>	20 cm x 2, 5 cm x 2
<b>Power Consumption</b>	70W
<b>Finish</b>	Cosmo black/Satin Wood
<b>Dimensions (including stand)</b>	1395 (W) x 485 (D) x 812.8 (H) mm
<b>Weight (including stand)</b>	71.7 kg

# ■ MIDI Implementation Chart

[KAWAI DIGITAL PIANO]  
MODEL MR3000

MIDI Implementation Chart

Date: Mar. 1989  
Version: 1.0

Function ...	Transmitted	Recognized	Remarks
<b>Basic Channel</b> : Default Changed	1 1—16	1 1—16	
<b>Mode</b> : Default Messages Altered	3 X *****	1 1,3 ** X	**The default for the OMNI mode is ON. Specifying MIDI channels automatically turns it OFF.
<b>Note Number</b> : True voice	21-108 * *****	0-127	
<b>Velocity</b> : Note ON Note OFF	O 9nH    V = 1-127 X 9nH    V = 0, 8nH	O X	V = 1-127
<b>After Touch</b> : Key's Ch's	X X	X X	
<b>Pitch Bender</b>	X	X	
<b>Control Change</b>	7 X 64 O (Right pedal) 66 O (Left pedal) 67 X (Left pedal)	O X X O	Volume Damper pedal Sostenuto pedal Soft pedal
<b>Prog Change</b> : True #	O (0-127) *****	O (0-127) (0-9)	10-127 = 0
<b>System Exclusive</b>	O	O	
<b>System Common</b> : Song Pos : Song Sel : Tune	X X X	X X X	
<b>System Real Time</b> : Clock : Commands	X X	X X	
<b>Aux Messages</b> : Local ON/OFF : All Notes OFF : Active Sense : Reset	X O O X	O O O X	
<b>Notes</b>	* 15-113 The value depends on the TRANSPOSE setting.		

Mode 1 : OMNI ON, POLY  
Mode 3 : OMNI OFF, POLY

Mode 2 : OMNI ON, MONO  
Mode 4 : OMNI OFF, MONO

O : Y  
X : N



# **KAWAI**

Kawai Musical Instruments Manufacturing Co., Ltd.  
200 Terajima-cho, Hamamatsu, Japan