

KAWAI

Digital Piano
CE200

Owner's Manual

Important Safety Instructions

SAVE THESE INSTRUCTIONS

INSTRUCTIONS PERTAINING TO A RISK OF FIRE, ELECTRIC SHOCK, OR INJURY TO PERSONS

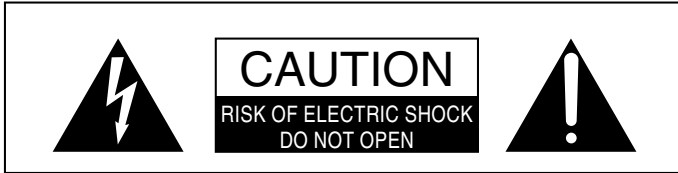

WARNING
TO REDUCE THE RISK OF FIRE OR ELECTRIC SHOCK, DO NOT EXPOSE THIS PRODUCT TO RAIN OR MOISTURE.

AVIS : RISQUE DE CHOC ELECTRIQUE - NE PAS OUVRIR.

TO REDUCE THE RISK OF ELECTRIC SHOCK, DO NOT REMOVE COVER (OR BACK). NO USER-SERVICEABLE PARTS INSIDE. REFER SERVICING TO QUALIFIED SERVICE PERSONNEL.



The lightning flash with arrowhead symbol, within an equilateral triangle, is intended to alert the user to the presence of uninsulated "dangerous voltage" within the product's enclosure that may be of sufficient magnitude to constitute a risk of electric shock to persons.



The exclamation point within an equilateral triangle is intended to alert the user to the presence of important operating and maintenance (servicing) instructions in the literature accompanying the product.

Examples of Picture Symbols

	denotes that care should be taken. The example instructs the user to take care not to allow fingers to be trapped.
	denotes a prohibited operation. The example instructs that disassembly of the product is prohibited.
	denotes an operation that should be carried out. The example instructs the user to remove the power cord plug from the AC outlet.

Read all the instructions before using the product.

WARNING - When using electric products, basic precautions should always be followed, including the following.

WARNING Indicates a potential hazard that could result in death or serious injury if the product is handled incorrectly.

The product should be connected to an AC outlet of the specified voltage.

			<ul style="list-style-type: none"> ● If you are going to use an AC power cord, make sure that its has the correct plug shape and conforms to the specified power voltage. ● Failure to do so may result in fire.
--	--	--	--

Do not insert or disconnect the power cord plug with wet hands.

Doing so may cause electric shock.

The chair must be used properly (it must be used only when playing the product).

- Do not play with it or stand on it.
- Only one person is allowed to sit on it.
- Do not sit on it when opening the lid.

Doing so may cause the chair to fall over or your fingers to be trapped, resulting in injury.

When using the headphones, do not listen for long periods of time at high volume levels.

Doing so may result in hearing problems.

Do not lean against the keyboard.

Doing so may cause the product to fall over, resulting in injury.

Do not disassemble, repair or modify the product.

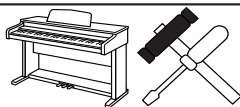

Doing so may result in product breakdown, electric shock or short-circuit.

When disconnecting the AC power cord's plug, always hold the plug and pull it to remove it.



● Pulling the AC power cord itself may damage the cord, causing a fire, electric shock or short-circuit.

The product is not completely disconnected from the power supply even when the power switch is turned off. If the product will not be used for a long time, unplug the AC power cord from the AC outlet.



● Failure to do so may cause fire in case of lightning.
● Failure to do so may over-heat the product, resulting in fire.

This product may be equipped with a polarized line plug (one blade wider than the other). This is a safety feature. If you are unable to insert the plug into the outlet, contact an electrician to replace your obsolete outlet. Do not defeat the safety purpose of the plug.

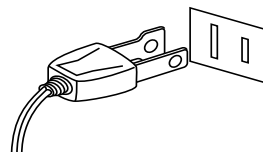

It is a good practice to have the instrument near the AC outlet and the power cord plug in a position so that it can readily be disconnected in an emergency because electricity is always charging while the plug is in the AC outlet even in a power switch off condition.



CAUTION

Indicates a potential hazard that could result in injury or damage to the product or other

Do not use the product in the following areas.

- Areas, such as those near windows, where the product is exposed to direct sunlight
- Extremely hot areas, such as near a heater
- Extremely cold areas, such as outside
- Extremely humid areas
- Areas where a large amount of sand or dust is present
- Areas where the product is exposed to excessive vibrations

Using the product in such areas may result in product breakdown. Use the product only in moderate climates (not in tropical climates).

When you close the keyboard cover, close it gently.

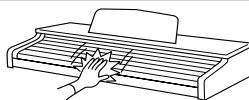

Closing it roughly may trap your fingers, resulting in injury.

Before connecting cords, make sure that the power to this product and other devices is turned OFF.



Failure to do so may cause breakdown of this product and other devices.

Take care not to allow any foreign matter to enter the product.



Entry of water, needles or hair pins may result in breakdown or short-circuit. The product shall not be exposed to dripping or splashing. No objects filled with liquids, such as vases, shall be placed on the product.

Do not drag the product on the floor. Take care not to drop the product.



Please lift up the product when moving it. Please note that the product is heavy and must be carried by more than two persons. Dropping the product may result in breakdown.

Do not place the product near electrical appliances such as TVs and radios.

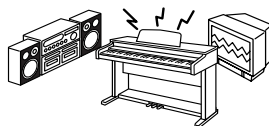

● Doing so may cause the product to generate noise.
● If the product generates noise, move the product sufficiently away from the electrical appliance or connect it to another AC outlet.

When connecting the AC power cord and other cords, take care not to get them tangled.



Failure to do so may damage them, resulting in fire, electric shock or short-circuit.

Do not wipe the product with benzene or thinner.



- Doing so may result in discoloration or deformation of the product.
- When cleaning the product, put a soft cloth in lukewarm water, squeeze it well, then wipe the product.

Do not stand on the product or exert excessive force.



- Doing so may cause the product to become deformed or fall over, resulting in breakdown or injury.

The product should be located so that its location or position does not interfere with its proper ventilation. Ensure a minimum distance of 5cm around the product for sufficient ventilation. Ensure that the ventilation is not impeded by covering the ventilation openings with items, such as newspaper, table-cloths, curtains, etc.

This product should be used only with the stand that is provided by the manufacturer.

Do not place naked flame sources, such as lighted candles on the product.

The product should be serviced by qualified service personnel when:

- The power supply cord or the plug has been damaged.
- Objects have fallen, or liquid has been spilled into the product.
- The product has been exposed to rain.
- The product does not appear to operate normally or exhibits a marked change in performance.
- The product has been dropped, or the enclosure damaged.

Notes on Repair

Should an abnormality occur in the product, immediately turn the power OFF, disconnect the power cord plug, and then contact the shop from which the product was purchased.

CAUTION:

To prevent electric shock, match wide blade of plug to wide slot, fully insert.

ATTENTION:

Pour éviter les chocs électriques, introduire la lame la plus large de la fiche dans la borne correspondante de la prise et pousser jusqu'au fond.

Instruction for AC power cord (U.K.)

Do not plug either terminal of the power cord to the ground of the AC outlet on the wall.

Canadian Radio Interference Regulations

This instrument complies with the limits for a class B digital apparatus, pursuant to the Radio Interference Regulations, C.R.C., c. 1374.



An information on Disposal for users

If your product is marked with this recycling symbol it means that, at the end of its life, you must dispose of it separately by taking it to an appropriate collection point. You should not mix it with general household waste. Disposing of this product correctly will prevent potential negative effects on the environment and human health which could otherwise arise due to inappropriate waste handling. For further details, please contact your local authority. (European Union only)

FCC Information (U.S.A)

NOTE: This equipment has been tested and found to comply with the limits for a Class B digital device, pursuant to Part 15 of the FCC Rules. These limits are designed to provide reasonable protection against harmful interference in a residential installation. This equipment generates, uses and can radiate radio frequency energy and, if not installed and used in accordance with the instructions, may cause harmful interference to radio communications. However, there is no guarantee that interference will not occur in a particular installation. If this equipment does cause harmful interference to radio or television reception, which can be determined by turning the equipment off and on, the user is encouraged to try to correct the interference by one or more of the following measures:

- Reorient or relocate the receiving antenna.
- Increase the separation between the equipment and receiver.
- Connect the equipment into an outlet on a circuit different from that to which the receiver is connected.
- Consult the dealer or an experienced radio/TV technician for help.

FCC WARNING: Changes or modifications not expressly approved by the party responsible for compliance could void the user's authority to operate the equipment.



Declaration of Conformity

This device complies with Part 15 of the FCC Rules. Operation is subject to the following two conditions: (1) this device may not cause harmful interference, and (2) this device must accept any interference received, including interference that may cause undesired operation.

Model Name :	CE200
Responsible Party Name :	Kawai America Corporation
Address :	2055 East University Drive Rancho Dominguez, CA 90220
Telephone :	310-631-1771

This applies only to products distributed by Kawai America Corporation.

THANK YOU FOR PURCHASING A KAWAI DIGITAL PIANO!

The Kawai digital piano is a revolutionary new keyboard instrument that combines the latest in electronic advances with traditional craftsmanship inherited from Kawai's many years of experience in building fine pianos. Its keyboard provides the touch response and full dynamic range required for a superb performance on the piano, harpsichord, organ, and other instruments. In addition, the CE200 piano is equipped with reverb and a digital effect processor for an even fuller sound. Industry-Standard MIDI (Musical Instrument Digital Interface) jacks are included which allow you to play other electronic instruments at the same time—opening a whole new world of musical possibilities.

This Owner's Manual contains valuable information that will help you make full use of this instrument's many capabilities. Please read all sections carefully and keep this manual handy for further reference.

READ ME FIRST

Before beginning the assembly of your CE200 read and become familiar with the assembly instructions that follow. Then, carefully unpack the piano and check your unit against the parts list.

PARTS PROVIDED

Side Panel (A)	2 pcs.
Back Board (B)	1 pc.
Pedal Board (C)	1 pc.
Screw D (M6 x 25)	4 pcs.
Screw E (M4 x 12)	4 pcs.
Screw F (ø4 x 20)	4 pcs.
Screw G (ø4 x 16)	10 pcs.
Adjuster (H)	1 pc.

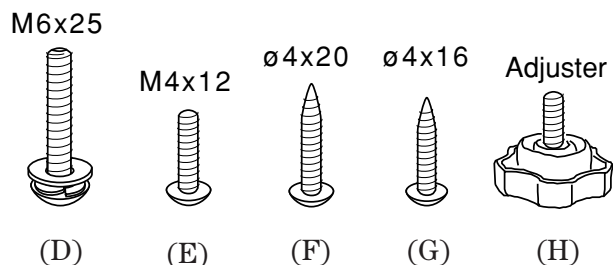

Headphone Hook	1 pc.
Screw (ø4 x 14)	2 pcs.

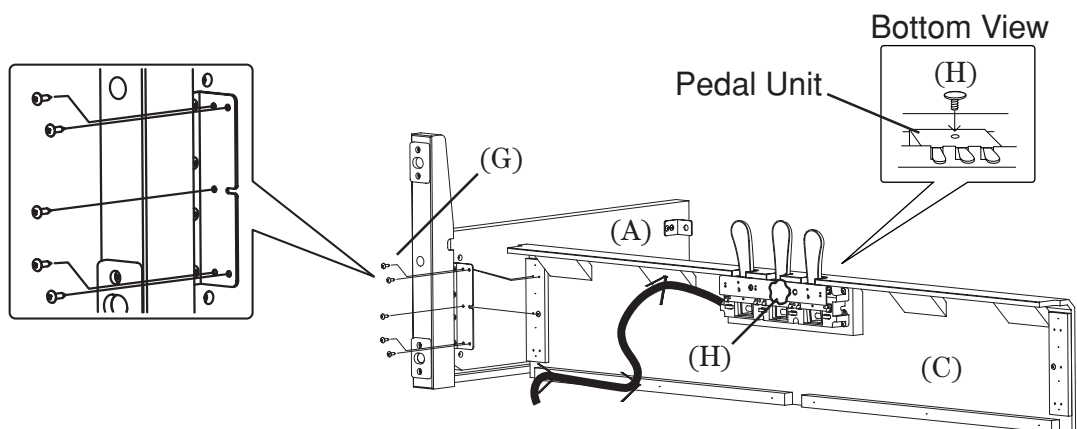

1. Insert the Adjuster (H) on the Pedal Unit.
2. Untie the pedal cable on the bottom of the Pedal Board (C).
3. Fasten the Side Panels (A) and the Pedal Board (C) with five screws (G) on both the left and right side of the instrument (totalling ten screws).

4. Hold the Back Board (B) behind the Pedal Board (C) and in front of the fixing metal of the Side Panels (A).
5. Fasten the Side Panels (A) and Back Board (B) with two screws (E) on both side of the instrument (totalling four screws).
6. Fasten the Pedal Board (C) and Back Board (B) with four screws (F).

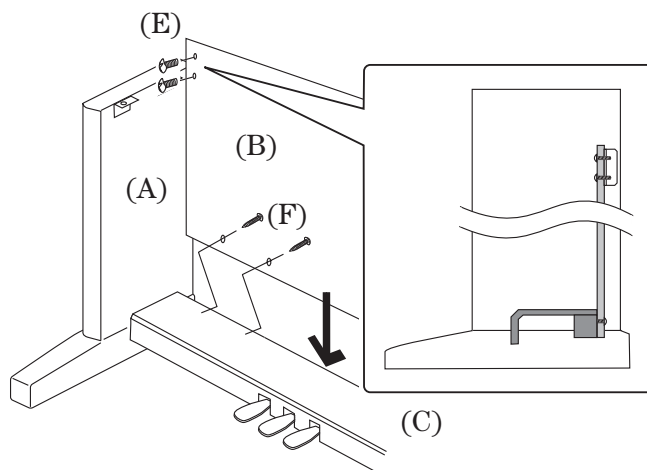

CAUTION:

To prevent personal injury, do not handle the main unit from the ends.

7. The next step requires one person on each end of the main unit. Grasp the unit with both hands, one under the front, the other under the rear (remember, not the end) and carefully center the main unit on top of the stand so that the hook brackets located on the bottom rear of the main unit are inside the stand side panels (A) and approximately one-third of the rear, top edge of the side panels are exposed. (See the illustration to the right)

8. Maintaining a firm grasp under the front of the main unit slide it toward the rear of the stand until the hook brackets engage the brackets at the rear top of the side panels (A). This hook arrangement is design to prevent the main unit from tilting forward while the screws are installed. Keep one hand under the front of the main unit, push down on the front to be certain that hooks are properly engaged.

9. Fasten the main unit and the stand with four screws (D).

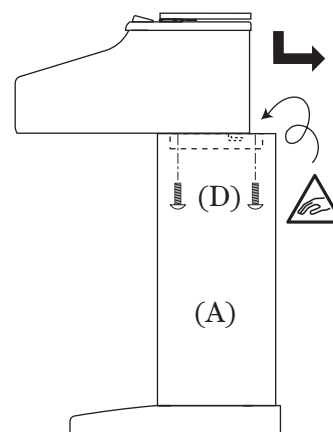

CAUTION:

Be sure to secure the main unit to the stand with the screws. If you fail to do so, the unit could fall from the stand causing damage or personal injury.

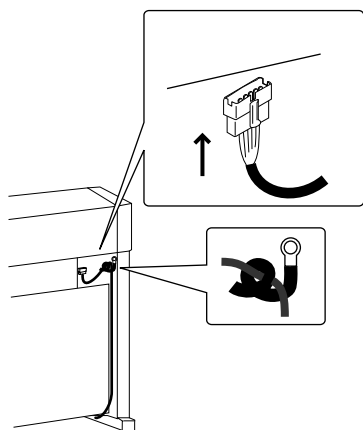

10. Insert the pedal connection cord that comes from Pedal Board into the main unit's pedal jack and fix with the clamp of the Side Panel.

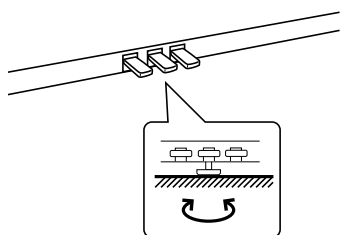

11. Turn the adjuster (installed on the bottom of the Pedal Unit) down until it makes firm contact with the floor. If the floor is carpeted, place a spiked furniture cup under the adjuster so that it makes firm contact with the carpet backing. Press any pedal with your foot. If the pedal rail flexes, lower the adjuster until flexing is minimized.

CAUTION:

Before moving your piano, turn the adjuster up so that it clears the floor.

ATTACHING THE HEADPHONE HOOK

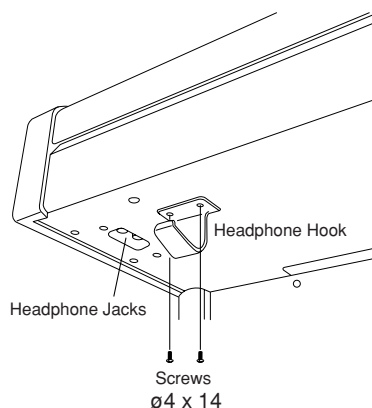

1. Attach the Headphone Hook with two screws (ø4 x 14) to the holes next to the headphone jacks.

1. Quick Start

p. 12

1.1 SETTING UP THE PIANO	12
1.2 POWER SWITCH	12
1.3 VOLUME SLIDER	12
1.4 HEADPHONES	12
1.5 DEMO SONGS.....	12
1.6 PLAYING THE PIANO.....	13
1.7 PEDALS	13
1.8 PLAYING WITH MORE SOUNDS	14

2. Advanced Playing

p. 15

2.1 VALUE BUTTONS	15
2.2 DUAL	15
2.3 SPLIT.....	16
2.4 FOUR HANDS MODE	16
2.5 DUAL/SPLIT BALANCE SLIDER	17
2.6 EFFECTS/REVERB.....	17
2.7 VOICING	19
2.8 METRONOME	20

3. Recorder

p. 22

BASICS OF THE RECORDER.....	22
3.1 RECORDING (REC BUTTON)	23
3.2 PLAYING BACK A SONG (PLAY/STOP BUTTON)	25
3.3 ERASING A SONG	26

4. Piano Music

p. 27

5. Function Buttons

p. 28

5.1 SELECTING THE TOUCH SENSITIVITY (TOUCH BUTTON)	28
5.2 TRANSPOSING THE PIANO (TRANSCOPE BUTTON)	29
5.3 OTHER FUNCTIONS (TOUCH & TRANSCOPE BUTTONS)	30
1. BRILLIANCE	31
2. TUNING	31
3. DAMPER RESONANCE	31
4. STRING RESONANCE	32
5. TEMPERAMENT	33
6. LOWER OCTAVE SHIFT	35
7. MIDI CHANNEL	36
8. SENDING PROGRAM CHANGE NUMBERS	36
9. LOCAL CONTROL ON/OFF	36
10. TRANSMIT PROGRAM CHANGE ON/OFF	37
11. MULTI-TIMBRAL ON/OFF	37
12. CHANNEL MUTE	38
13. LOWER PEDAL ON/OFF	38
14. LAYER OCTAVE SHIFT	39
15. LAYER DYNAMICS	39
16. DAMPER HOLD	40
17. USER MEMORY / FACTORY RESET	40

6. Using MIDI

p. 42

UNDERSTANDING MIDI	42
6.1 USING THE CE200 PIANO AS CONTROLLER	44
6.2 USING THE CE200 PIANO AS A MULTI-TIMBRAL SOUND MODULE	47

7. Jacks

p. 50

MIDI JACKS	50
USB JACK	50
LINE OUT JACKS	52
LINE IN JACKS	52
HEADPHONE JACKS	52

8. Appendices

p. 54

PROGRAM CHANGE NUMBER MAPPING	54
RHYTHM STYLE LIST	54
PIANO MUSIC LIST	55
FRONT PANEL	56
SOUND DEMO SONG LIST	56
SPECIFICATIONS	57
MIDI EXCLUSIVE DATA FORMAT	58
MIDI IMPLEMENTATION CHART	59



1. QUICK START

1.1 SETTING UP THE PIANO

The first thing you'll need to do before playing the piano is to set up the instrument.

ASSEMBLING THE STAND

First, you need to assemble the stand unit. Assemble the stand following the instructions at the beginning of this manual.

SUPPLYING AC POWER

The CE200 piano is equipped with stereo speakers and an amplifier. You do not need any other equipment to play your piano. You can enjoy the CE200 piano wherever AC power is available. Simply connect the power cable that comes with the CE200 piano to an AC outlet.

Connect the AC power cable to the piano's power jack and the other end of the cable to the AC outlet on the wall.

1.2 POWER SWITCH



**Press this button to turn on the power.
Pressing it again will turn off the power.**

Pressing this button while holding down the REC and PLAY/STOP buttons will erase all the songs currently stored in the Recorder. (See page 26.)

1.3 VOLUME SLIDER

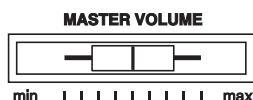

This slider controls the master volume level of the piano's sound.

Move this slider to the right to increase the volume and move to the left to decrease the volume.

This slider also controls the headphone's volume and the LINE output level of the piano's sound.

1.4 HEADPHONES

For private performances you may want to use the headphones. The speakers will be turned off automatically when the headphones are plugged in, and the CE200 piano will only be heard through the headphones. The CE200 piano has two headphones jacks.

1.5 DEMO SONGS

The CE200 has 18 built-in sound demo songs. Each of the demo songs presents a musical piece to introduce the different preset sounds.



Press the **DEMO button** and the demo song for the Piano 1 category will start. After the Piano 1 demo songs are finished playing, the demo songs for another sound category will be selected at random.

If you would like to listen to the demos for a particular category, just press the desired SOUND SELECT button while the demo is playing. When you press the button, the demo will play the demo songs for the newly selected category. Then the demo songs for another category will be selected at random. See page 56 for the list of sound demo songs.

1.6 PLAYING THE PIANO



Turning on the power.

You will find the POWER SWITCH at the right end of the front panel. Press this button to turn on the power. Pressing it again will turn off the power.



Adjust the volume level.

The VOLUME SLIDER controls the volume level of the speakers and the headphones. Use this slider to set the volume to a comfortable listening level.

Now try playing the keyboard.

You will hear the CE200's main piano sound.

The CE200 piano responds just like a real acoustic piano when you play it. It produces a louder sound when you play hard and a softer sound when you play soft. The volume level changes in relation to how fast the keys are pressed. This system is called “**touch sensitivity**” on an electronic musical instrument. The initial touch sensitivity setting has been adjusted to the standard of an acoustic piano. You can however, select a different type of touch sensitivity on the CE200 piano if you are not comfortable with the standard setting. For more detail, please read “**5.1 Selecting the Touch Sensitivity (TOUCH Button)**” on page 28.

1.7 PEDALS

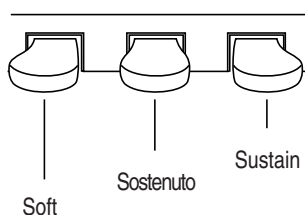

The CE200 piano has three pedals—just like a grand piano. They are Sustain, Soft and Sostenuto.

The sustain pedal is capable of responding to half pedaling, which provides even finer control of the dampening effect.

1.8 PLAYING WITH MORE SOUNDS

You have already heard the CE200's main piano sound. The CE200 has a total of 20 sounds, not only different types of piano sounds but different instruments as well.

The different instrument sounds built into CE200 piano are called “**preset sounds**”.

All of the preset sounds have been created through advanced digital sampling technology achieving as natural and realistic sound as possible. Let's try some of the preset sounds.

SELECTING ANOTHER PRESET SOUND

Press the **SOUND SELECT** button under the name of the instrument you would like to listen to. When the button is pressed, the LED indicator will be turned on to indicate that this sound is selected.

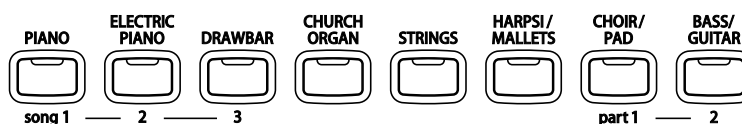

The SOUND SELECT buttons are assigned with two or three preset sounds to select. **To select the other sounds, press the button repeatedly.**

Sound variation
number 1



When a SOUND SELECT button is pressed, the variation number is briefly shown in the display. Pressing the same SOUND SELECT button again will select the next variation sound assigned to the SOUND SELECT button.



You can also select any preset sounds by using the VALUE buttons.

2. ADVANCED PLAYING

2.1 VALUE BUTTONS



These two buttons are used to change the value for certain functions.

First select the function or option you would like to change the value for by pressing the appropriate button(s), then use the VALUE buttons to change the value. “▲” button increases the value and “▼” decreases the value.

These buttons can also be used to select the various sounds. You can select all of the preset sounds assigned to the eight SOUND SELECT buttons.

However, Sounds cannot be selected by using the VALUE buttons when you are in DUAL or SPLIT mode.

2.2 DUAL

Another feature of the CE200 piano is the ability to layer two preset sounds together to create a more complex sound. For example, piano layered with strings, electric piano with choir sound, and so on.

To layer two sounds, **select the first sound and then, while holding down that SOUND SELECT button, select the second sound by pressing another SOUND SELECT button.** The LED indicators for each will be turned on to indicate the two sounds you have chosen. The display briefly shows the combination of the selected sound variation numbers.

Sound variation number 1 and 3 are layered.

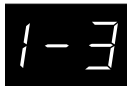

If you want to layer two sounds assigned to the same SOUND SELECT button, while pressing the desired SOUND SELECT button use the VALUE buttons to select your desired layered sound.

ABOUT POLYPHONY

The CE200 piano is capable of playing up to 96 notes simultaneously (96-note polyphony). When playing in dual mode, or when playing the stereo piano sound, the polyphony will be reduced by half since the piano has to produce two sounds for each note.

2.3 SPLIT



Variation 2 for lower and 1 for upper.



SELECTING SPLIT SOUNDS

The split function divides the keyboard into two sections—upper and lower—and lets you play each part with a different sound.

First press the desired SOUND SELECT button to select the upper sound. Then, while holding down the SPLIT button, press the desired SOUND SELECT button to select the lower sound. The LED indicator for the upper sound will be turned on and the LED for the lower sound will start flashing. The display shows the combination of the selected sound variation numbers during the SPLIT button is pressed. The number on the left is for lower sound and the number on the right is for upper sound.

CHANGING THE SPLIT POINT

The default split point is set between B2 and C3. This point can be moved to anywhere on the keyboard.

Press the desired key on the keyboard while holding down the SPLIT button.

The key you pressed becomes the lowermost note for the upper section.

2.4 FOUR HANDS MODE

It is possible to divide the keyboard into left and right sections at the default split point, and to play both sections in the same key range using the four hands mode. The key range is lowered by two octaves for the right section, and raised by two octaves for the left section. When four hands mode is active, the sustain pedal (right pedal) acts as the sustain pedal for the right section, and the soft pedal (left pedal) acts as the sustain pedal for the left section. When four hands mode is active the CE200 functions as two pianos, so you can enjoy duet performances or use one CE200 piano for two students or a teacher and a student.

ENTERING FOUR HANDS MODE

Press the sustain pedal and the soft pedal while holding down the SPLIT button. The SPLIT button LED indicator will start blinking and the piano is now in Four Hands Mode.



EXITING FOUR HANDS MODE

To exit Four Hands Mode, press the SPLIT button again. The LED indicator will be turned off.

SELECTING SOUNDS IN FOUR HANDS MODE

The method for selecting sounds is the same as in Split Mode. After you are in Four Hands Mode simply use the SOUND buttons to change the sound for the upper section. To change the sound for the lower section, press and hold the SPLIT button and then use the SOUND buttons.

CHANGING SPLIT POINT

The method for changing the split point is the same as in Split Mode. After you are in Four Hands Mode press and hold the SPLIT button and press any key on the keyboard. The key you pressed becomes the lowest note for the upper section. The default split point is set between E3 and F3.

OCTAVE SHIFT FOR THE LOWER SECTION

When in Four Hands Mode, you can use the Octave Shift function to change the octave of the lower section. Please see page 35 for more information on using Octave Shift.

2.5 DUAL/SPLIT BALANCE SLIDER



You can adjust the volume balance between the two sounds in Dual or Split mode. **Use the Dual/Split Balance slider to adjust the balance.** Move the slider to the right to increase the volume of the rightmost sound (in dual mode) or upper sound (in split mode) and decrease the volume of the leftmost sound (in dual mode) or lower sound (in split mode). The balance changes in the opposite way when the slider is moved to the left.

2.6 EFFECTS/REVERB

You might have noticed that when you select some of the preset sounds, the LED indicator for the EFFECTS or the REVERB is turned on. The reason for this is some of the preset sounds are set up with an effect on as their initial setting.

Adding an effect to the sound enhances tonal quality and improves acoustical realism. The CE200 piano is provided with two separate groups of effects. The first is reverb and the second contains chorus, delay, tremolo and rotary speaker.



REVERB

Reverb adds reverberation to the sound, simulating the acoustic environment of a recital room, stage, or concert hall. There are five types of reverb available. They are Room 1&2, Stage, and Hall 1&2. (listed in order of reverberation amount).



CHORUS

Chorus is an effect that simulates the rich character of a vocal choir or string ensemble, by layering a slightly detuned version of the sound over the original to enrich it.

DELAY

Delay is an effect that adds echoes to the sound.

TREMOLO

This is a vibrato type effect.

ROTARY

This effect simulates the sound of the Rotary Speaker cabinet commonly used with electronic organs. Rotary 1 is normal rotary and Rotary 2 is with distortion effect.

The soft pedal is used to change the speed of the rotor between SLOW and FAST.

TO ADD REVERB

Press the REVERB button. The LED indicator will be turned on to indicate that reverb is in use. Press and hold the REVERB button and the currently selected reverb type will be shown in the display.



Room 1

Room 2

Stage

Hall 1

Hall 2

To change the reverb type, **use the VALUE buttons while holding down the REVERB button.**

TO ADD OTHER EFFECTS

Press the EFFECTS button. The LED indicator will be turned on to indicate that the effect is in use. Press and hold the EFFECTS button and the currently selected effect will be shown in the display.



Chorus

Delay

Tremolo

Rotary 1

Rotary 2

To change the effect type, use the **VALUE** buttons while holding down the **EFFECTS** button.

To turn off the reverb or effects, press the **REVERB** or **EFFECTS** button again.

2.7 VOICING

Voicing is a technique used by piano technicians to mold the character of a piano's sound. The voicing function lets you adjust the CE200 piano's tone character by choosing one of three types of voicings, Mellow, Dynamic, Bright.



NORMAL

(When the LED indicator is turned off)

Produces the normal tone character of an acoustic piano throughout the entire dynamic range. This is the default voicing.

MELLOW

Produces a softer mellow tone character throughout the entire dynamic range.

DYNAMIC

The tone character will change dramatically from mellow to bright depending on how soft or loud you play.

BRIGHT

Produces a brighter tone character throughout the entire dynamic range.

Press the VOICING button. The LED indicator will be turned on to indicate that voicing is in use. Press and hold the VOICING button and the currently selected voicing type will be shown in the display.



Mellow



Dynamic



Bright

To change the voicing type, use the **VALUE** buttons while holding down the **VOICING** button.

Press the Voicing button again to return to the normal voicing setting.

Voicing selection is global for all the preset tones. You cannot have an individual setting for each tone.

2.8 METRONOME

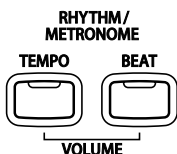

The voicing setting defaults to "Normal" each time the power is turned off. You can use the user memory function (page 40), to save your selected voicing. This way your current voicing selection will remain even after the power is turned off.

Rhythm is one of the most important elements when learning music. It is important to practice playing the piano at the correct tempo and with a steady rhythm. The CE200 piano's metronome is a tool that helps you to achieve this by providing a steady beat for you play along with.

STARTING THE METRONOME

Press the TEMPO button. You will see the LED indicator turn on and hear the metronome begin counting with a steady beat. The display shows the tempo in beats per minute.



To change the tempo, use the VALUE buttons to increase or decrease the tempo within the range of 10 - 400 beats per minute. (20 - 800 BPM with eighth note rhythms).

To stop the metronome, press the TEMPO button again.

CHANGING THE TIME SIGNATURE

You probably noticed that there are two types of clicks and the louder one comes every fourth beat. The metronome is capable of giving you a down beat to indicate the beginning of the measure. You are now hearing a 4-beat or 4/4 time signature.

You can select a different time signature, if you want to. There are seven different time signatures available on the CE200 piano—1/4, 2/4, 3/4, 4/4, 5/4, 3/8 and 6/8.

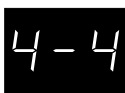

To change the time signature, use the BEAT button.

Press the BEAT button. You will see the LED indicator turn on and hear the metronome begin counting. The display shows the time signature.

Use the VALUE buttons to select your desired time signature. You will see the time signature currently selected in the display.

RHYTHM METRONOME

You can also select from 30 additional rhythm styles instead of a simple metronome click.

Keep pressing the VALUE buttons to select the desired rhythm style number. See page 54 for the rhythm style list.



The selected Rhythm Style is displayed.

To stop the metronome, press the BEAT button again.

You can use either the TEMPO or BEAT button to turn the metronome on and off. Choose the appropriate button depending on whether you're adjusting the tempo or changing the time signature.

ADJUSTING THE METRONOME VOLUME

The volume level of metronome can be adjusted to any level you like independent of the main volume.

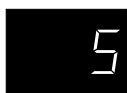

Press the TEMPO and BEAT buttons simultaneously. The display shows the volume level of the metronome in numbers from 1 (soft) to 10 (loud). The factory preset is 5.

Use the VALUE buttons to change value.



3. RECORDER

The CE200 piano's recorder records your playing much like a tape recorder, and it is just as easy to use. The CE200 piano records a song as digital data instead of audio data and stores the song inside the instrument. Because the song is stored as digital information you can modify the song when you play it back. You can, for example, adjust the tempo without changing the pitch or use a different effect setting from one you have recorded.

Once you understand the recorder, you will find it to be a useful tool for both practicing and playing the piano.

BASICS OF THE RECORDER

Let's take a brief look at the recorder's features.

TWO-TRACK THREE-SONG RECORDER

The CE200 piano's recorder is a **2-track 3-song recorder**. This means you can record up to three different songs, store them in memory, and play them back as you like.

Each song has two separate tracks called "**Parts**" that can be recorded separately. This lets you record for example, the left hand part first on one track, then record the right hand part next on the other track while listening to the first track.

When you record or play back a song, you can select which part (track) of which song you are going to record or play back. When you are recording, selecting the same part again to record will erase any previous recordings on that part. Because of this it's important to remember; when recording both parts separately, after recording the first part be sure to select the second part to record, otherwise you will end up recording over the first part of the song.

RECORDED INFORMATION

The CE200 piano records the following:

Note information

Sound selection

Pedal movements

Balance settings Set the dual/split balance as desired before you start recording. Balance settings made before you start recording will be used by the recorder. Any changes made during the recording will be ignored by the recorder.

Transpose When you record in a different key using the transpose function, the CE200 piano will record the actual transposed notes you hear, not the notes as you play with the keyboard.

RECORDING CAPACITY

The total recording capacity is about 15,000 notes. Pressing any buttons or pedals is counted as one note.

When the recorder reaches it's maximum capacity, the CE200 piano will stop recording at that point.

RECORDER AND METRONOME

When playing back a song with the metronome turned on, the metronome always restarts with the down beat.

3.1 RECORDING (REC BUTTON)

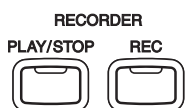

The REC button is used for recording.

Press the REC button when you are ready to record. The LED indicator will start flashing telling you that the piano is ready to record.

Now play some music on the piano. The recorder will automatically start recording with the first note you play.

Press the PLAY/STOP button when you are finished recording. The piano will stop recording and save your song to memory.

Saving to memory may take a few moments and during this time the piano will not perform any other operations.

You can start recording by pressing the PLAY/STOP button instead of pressing a key. In this way, you can insert a blank bar at the beginning of the song.

If you make a mistake, you can record your piece again. Just repeat the same procedure. The second recording will completely erase the first one.

RECORDING ANOTHER SONG

The CE200 piano is capable of recording and storing up to three different songs. Let's try recording a second song.

If you followed the procedure in the previous section you have already recorded Song 1, so now let's record Song 2.

To select the song number, use the **SOUND SELECT** buttons with the song numbers printed under them—**PIANO 1**, **ELECTRIC PIANO** and **DRAWBAR**. Press the **ELECTRIC PIANO** button to select **Song 2** while holding down the **REC** button. The LED indicator of **ELECTRIC PIANO** will begin to flash when the **REC** button is pressed.

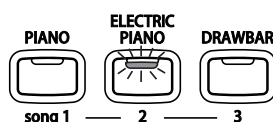

When you are ready to record, just start playing the keyboard.

The CE200 piano will start recording automatically with the first note you play.

Press the **PLAY/STOP** button when you are finished recording.

RECORDING A SECOND PART

You can record a second part in the second track (part) of the same song. After recording the first part, select the other track and record your second part.

While holding down the **REC** button, press the **DRAWBAR** button to select **Song 3**.

Record the first part just the same as in the previous sections and press the **PLAY/STOP** button when you're finished recording.

Now press and hold the **REC** button again and press the **BASS / GUITAR** button to select **Part 2** to record.

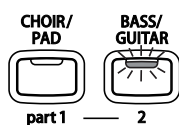

If you want to start recording the second part from the beginning of the song, **just play the keyboard**. You will hear the first part playing back while you record the second part.

If you would like to play back the first part and then start recording the second part from a certain point later in the song, press the **PLAY/STOP** button instead of playing the keyboard to start playback of the first part and then begin recording the second part from any point you like.

When you are finished recording, press the **PLAY/STOP** button again.

STATUS OF SONG AND PART

You have probably noticed that some of the LED indicators are flashing, some are turned on, and some are turned off. The LED indicates the status of recording and play back as shown below.



The LED that is on indicates that the song or part has already been recorded.



The flashing LED indicates that the song or part is selected to record or play back.



The LED that is off indicates that the song or part is empty.

If you have recorded more than one song, you can check the song status, by pressing the **REC** or **PLAY/STOP** button.

3.2 PLAYING BACK A SONG (PLAY/STOP BUTTON)

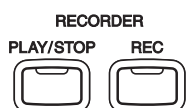

The **PLAY/STOP** button is used to select a song and part to play, and to start and stop play back of the recorded songs.

Press the PLAY/STOP button and the recorded song will start playing.

Press the PLAY/STOP button again to stop play back.

If you would like to listen to a different song, **select your desired song number using the SOUND SELECT buttons while holding down the PLAY/STOP button and then release the buttons to start play back.** The LED indicator for the selected song will flash when holding down the **PLAY/STOP** button.

PLAYING BACK THE PARTS SEPARATELY

When you select a song recorded with two parts, you can play back the parts separately.

Hold down the PLAY/STOP button and look at the Part buttons. The LED indicators for both parts will be on, indicating that you have successfully recorded two tracks. **Release the PLAY/STOP button to listen to what you have recorded.** You should hear both parts.

To play back an individual part, **use the Part buttons while holding down the PLAY/STOP button to turn on/off each part.** If the LED indicator is on, that part will play. If the LED indicator is off, that part will not play.

USING THE PLAY/STOP BUTTON TO START RECORDING

The PLAY/STOP button can also be used to start recording. In this way, you can insert a blank bar at the beginning of the song.

Press the REC button to enable the piano to record first, then press the PLAY/STOP button. On pressing the PLAY/STOP button, the CE200 piano starts recording regardless of whether you press a key or not.

3.3 ERASING A SONG

This function allows you to erase any song you do not want to listen to.

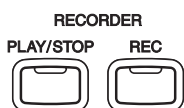

To erase a specific song and part, **first hold down both the REC and PLAY/STOP buttons.** The LED indicators will display which songs have been recorded.

Select the desired song to erase by pressing the appropriate SOUND SELECT button while continuing to hold down both the REC and the PLAY/STOP buttons. The LED indicator of the selected song will start flashing.

Press the Part button you want to erase and turn the LED indicator off. The part will be erased. When both parts for a song are erased, the song becomes empty.

ERASING ALL THE SONGS

To erase all the songs at once, **first turn off the power and then turn it on again while holding down both the REC and PLAY/STOP buttons.**



4. PIANO MUSIC

Pressing the PIANO MUSIC button lets you enter the Piano Music mode. The CE200 piano provides pre-recorded Classical piano music for your listening pleasure.

All of the song titles are listed in "PIANO MUSIC LIST" on page 55.

Press the PIANO MUSIC button.

The LED indicator for the PIANO MUSIC button will be turned on, and the display will show the Piano Music selection number.



Use the VALUE buttons to select your desired song.

Songs can be changed while the selected song is being played.

Start the song by pressing the PLAY / STOP button.

To stop the song, press the same button again.

Move the slider to the left. The volume of the right-hand part of the song is decreased.

Move the slider to the right. The volume of the left-hand part of the song is decreased.

Press the PIANO MUSIC button again to exit the piano music mode.

5. FUNCTION BUTTONS

5.1 SELECTING THE TOUCH SENSITIVITY (TOUCH BUTTON)



Touch lets you select a different touch sensitivity for the keyboard from the standard touch of an acoustic piano. You can change the sensitivity to one of five different settings: LIGHT 1, LIGHT 2, HEAVY 1, HEAVY 2, OFF or User.



Light 1 For those still developing finger strength. A louder volume is produced even when playing with a soft touch.



Light 2 For players with a delicate touch. Requires less striking force to achieve a forte note.



Heavy 1 Perfect for those with strong fingers. Requires a heavier touch to produce a loud volume.



Heavy 2 Requires more striking force to achieve a loud volume.



Off A constant volume is produced regardless of how hard the keys are struck. This setting is suitable for sounds that have a fixed dynamic range such as Organ and Harpsichord.



User You can create your own custom touch curve to fit your playing style.

To change from the standard touch, press the TOUCH button. The LED indicator above the TOUCH button will be turned on to indicate that the piano is now using a different touch setting.

Use the VALUE buttons to change the type of touch while the TOUCH button is held down.

Press the TOUCH button again to get back to the standard touch setting.

Touch selection is global for all the preset tones. You cannot have an individual setting for each tone.

Once the power is turned off, the setting will be reset to the standard setting.

◆ NOTE

LIGHT and HEAVY do not represent the physical weight of the keys. These are settings that affect the sensitivity of the keys, which determines the volume level in response to the key movement.

USER TOUCH

Let's create your own custom touch curve which will fit your playing style.



Use the VALUE buttons to select “User” while holding down the TOUCH button.



While still holding the TOUCH button, press the REC button. The display will show “Play”.



Now start playing the CE200 piano dynamically from soft to loud in order to let the CE200 piano analyze your playing style. While you are playing, the display changes to show three dots at the bottom.



Press the PLAY/STOP button when you finish playing. The CE200 piano will analyze your playing and create a custom touch curve for you based upon your playing style. The display briefly shows “Done”.

◆ NOTE

The user touch curve data is saved automatically even after the power is turned off.

5.2 TRANSPOSING THE PIANO (TRANSPOSE BUTTON)



The transpose function lets you raise or lower the piano's key in half steps. This is especially useful when you have learned a song in one key and have to play it in another key. The transpose feature allows you to play the song in the original key, but hear it in another key.

Press and hold the TRANSPOSE button. While still holding the TRANSPOSE button, use the VALUE buttons or the keyboard from C2 to C4 to specify the transposition amount.



The display shows you a number telling you how many half steps up or down you have transposed the piano. -5, for example, represents a transposition that is 5 half steps lower. “0” indicates no transposition.

The piano can be transposed up to 12 half steps higher or 12 half steps lower.

Pressing TRANSPOSE button again turns the TRANSPOSE function off.

The TRANSPOSE function remembers the current setting as long as the power is on.

5.3 OTHER FUNCTIONS (TOUCH & TRANSPOSE BUTTONS)

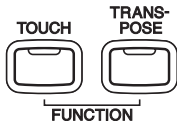

There are 17 other functions that control tuning, system, and MIDI functions. They are Brilliance, Tuning, Damper Resonance, String Resonance, Temperament, Lower Octave Shift, MIDI Transmit and Receive Channel, Program Change Number, Local On/Off, Transmit Program Change On/Off, Multi-Timbral Mode, Channel Mute, Lower Pedal On/Off, Layer Octave Shift, Layer Dynamics, Damper Hold and **User Memory / Factory Reset, User / Factory Execution.**

These functions are selected by pressing one of the buttons on the panel while holding down both the TOUCH and the TRANSPOSE buttons. The functions are assigned as listed below.

Brilliance	DEMO
Tuning	PIANO MUSIC
Damper Resonance	VOICING
String Resonance	PIANO
Temperament	E.PIANO
Lower Oct. Shift	Drawbar
MIDI Channel	CHURCH ORGAN
Prog Change Number	STRINGS
Local Control	HARPSI / MALLETS
Trans. Prg ON/ OFF	CHOIR / PAD
Multi Timbral Mode	BASS / GUITAR
Channel Mute	EFFECTS
Lower Pedal ON/OFF	REVERB
Layer Octave Shift	SPLIT
Layer Dynamics	TEMPO
Damper Hold	BEAT
User Memory / Factory Reset	PLAY
User / Factory Execution	REC

The LED indicator of the button will flash to show which function is selected.

To exit the function, **press any of the SOUND SELECT buttons or the TOUCH or the TRANSPOSE button.**

Once the power is turned off, the settings will be reset to the factory preset value.

You can use the user memory function (page 40), to save your desired settings. This way your current settings will remain even after the power is turned off.

1. BRILLIANCE

Brilliance lets you adjust brightness of the sounds.

Press the DEMO button while holding down the TOUCH and the TRANSPOSE buttons.



The display alternatively shows "bri" (= brilliance) and a number that represents the value.



Use the VALUE buttons to select the value within the range of -10 to +10. Plus settings produce a brighter tone, minus settings produce a mellower tone.

The Brilliance setting defaults to "0" each time the power is turned off.

2. TUNING

Tuning allows you to adjust the piano's pitch. You may need to adjust the tuning when you play with other instruments.

Press the PIANO MUSIC button while holding down the TOUCH and the TRANSPOSE buttons.



The display alternatively shows "tun" (= Tuning) and a number that represents the pitch for "A" in Hz (Hertz). The range of adjustment is from 427.0 to 453.0 Hz (displayed as 27.0–53.0). The factory preset value is set to the modern standard A = 440.0 Hz (displayed as 40.0).



Use the VALUE buttons to raise or lower the pitch.

3. DAMPER RESONANCE

When the sustain pedal (page 13) is depressed on an acoustic piano, all the dampers are lifted up allowing the strings to vibrate freely. When you play note or chord on the piano with the sustain pedal depressed, not only will the strings for the notes you played vibrate but other strings will vibrate in sympathetic resonance. The damper resonance function simulates the phenomenon.

Press the VOICING button while holding down the TOUCH and the TRANSPOSE buttons. You can adjust the volume of the damper resonance.



The display alternatively shows “dEF” (= Damper Effect) and a number that represents the value.

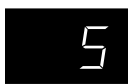

Use the VALUE buttons to set the volume within a range of "Off, 1 to 10 and 5 is the default setting.

Damper resonance will not be active when "Off" is selected.

The damper resonance volume defaults to "5" each time the power is turned off.

The damper resonance function is effective only for the following piano sounds: Concert Grand, Studio Grand, Mellow Grand

4. STRING RESONANCE

The string resonance function simulates the phenomenon of string resonance on an acoustic piano.

Press the PIANO button while holding down the TOUCH and the TRANSPOSE buttons. You can adjust the volume of the string resonance.



The display alternatively shows “Str” (= String Resonance) and a number that represents the volume.



Use the VALUE buttons to set the volume within a range of "Off, 1 to 10 and 5 is the default setting.

String resonance will not be active when “Off” is selected.

ABOUT STRING RESONANCE

Even when the sustain pedal is not depressed on an acoustic piano, the strings for any notes you are holding will be un-damped and will resonate freely in sympathy with the strings of other notes that you play if they are part of the same harmonic series. In addition, adjacent notes will also be resonated. The string resonance function simulates this phenomenon. This is called "string resonance."

For example, when you play the keys shown in next page while holding down the C key, the string of the C key resonates and produces a sound.

(Quietly press and hold down the C key, and then quickly tap each of the keys shown below. You can hear the string resonate.)

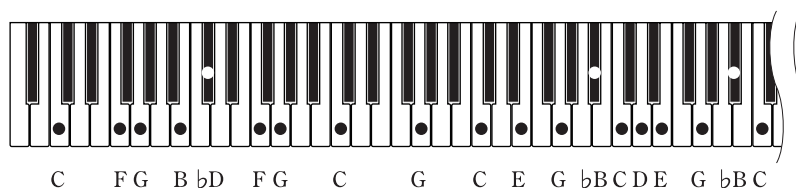

Hold down the key.

When you play a key while holding down an adjacent key, an acoustic piano produces a sound as a result of string resonance. The CE200 simulates this phenomenon.

The string resonance volume defaults to "5" each time the power is turned off.

String resonance is not active when the sustain pedal is depressed. The string resonance function is effective only for the acoustic piano sounds.

5. TEMPERAMENT

The CE200 piano offers not only equal temperament (the modern standard) but also immediate access to temperaments popular during the Renaissance and Baroque periods. It should be interesting and educational to try some of the different temperaments, although the equal temperament is dominant today.

Press the E.PIANO button while holding down the TOUCH and the TRANSPOSE buttons.



The display alternatively shows "tMP" (= Temperament) and the symbol that indicates which type of temperament is in use.

Use the VALUE buttons to change the type of temperament.

BRIEF EXPLANATION OF TEMPERAMENTS



EQUAL TEMPERAMENT (PIANO ONLY)

This is the default temperament. If a piano sound is selected the tuning is stretched like an acoustic piano (EQUAL TEMPERAMENT). If any other type of sound is selected the tuning will be EQUAL (FLAT). An explanation of EQUAL TEMPERAMENT and EQUAL TEMPERAMENT (FLAT) is provided later in this section.

◆ NOTE

If a piano sound is used in a layer with any other sound then both sounds will use the EQUAL TEMPERAMENT (Stretched) tuning.



MERSENNE PURE TEMPERAMENT (MAJOR)

MERSENNE PURE TEMPERAMENT (MINOR)

This temperament, which eliminates dissonance's for thirds and fifths is still popular for choral music because of its perfect harmony.

You need to be aware what key you are playing in with this temperament. Any key modulation will result in dissonance's. When you play music in a particular key, you need to match the key of the temperament as well. When playing in a major key select Pure (Major) and when playing in a minor key select Pure (minor).



PYTHAGOREAN TEMPERAMENT

This temperament, which uses mathematical ratios to eliminate dissonance for fifths, is very limited for use with chords, but it produces very characteristic melodic lines.



MEANTONE TEMPERAMENT

This temperament, which uses a mean between a major and minor whole tone to eliminate dissonance for thirds, was devised to eliminate the lack of consonance's experienced with certain fifths for the Mersenne pure temperament. It produces chords that are more beautiful than those with the equal temperament.



WERCKMEISTER III TEMPERAMENT

KIRNBERGER III TEMPERAMENT

These two temperaments are placed in between Meantone and Pythagorean. For music with few accidentals, this temperament produces the beautiful chords of the mean tone, but as accidentals increase, the temperament produces the characteristic melodies of the Pythagorean temperament. It is used primarily for classical music written in the Baroque era to revive the original characteristics.



EQUAL TEMPERAMENT (FLAT)

This is "unstretched" equal temperament that divides the scale into twelve equal semitones. This produces the same chordal intervals in all twelve keys, and has the advantage of limitless modulation of the key. However the tonality of each key becomes less characteristic and no chord is in pure consonance.



EQUAL TEMPERAMENT

This is the most popular piano temperament. The hearing ability of a human is uneven and is not as accurate with high frequency and low frequency as it is with the middle range. This temperament's tuning is stretched to compensate for this so the sound will be heard naturally to

the ears. This “Stretched” equal temperament is a practical variation of the “unstretched” equal temperament which was invented on a mathematical basis.

◆ **NOTE**

After you have selected the desired temperament, please read the following section on selecting a key signature for the temperament before continuing.

KEY SIGNATURE OF TEMPERAMENT

Limitless modulation of the key became available only after the invention of Equal temperament. When we use a temperament other than Equal temperament, we must carefully choose the key signature to play in.

For example, if the song you are going to play is written in D major, choose “D” as the temperament key.

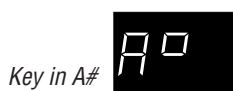

To select the key signature of the temperament, simply press one of the 88 piano keys. The note name of the key you pressed will be shown in the display and it will be chosen as the key of the temperament.

◆ **NOTE**

Changing the key of the temperament will only change the “balance” of the tuning, the pitch of the keyboard remains unchanged. Use the TUNING or TRANSPOSE functions to change the pitch of the whole keyboard.

6. LOWER OCTAVE SHIFT

This allows the octave of the lower part to be shifted up one, two, or three octaves higher when you use the split function.



Press the DRAWBAR button while holding down the TOUCH and the TRANSPOSE buttons.



The display alternatively shows “Lot” (= Lower Octave) and a number which represents how many octaves the lower part is shifted up.

Use the VALUE buttons to set the desired lower octave shift range.

Lower Octave Shift can be set between 0 to 3.

7. MIDI CHANNEL

This determines on which MIDI channel the CE200 piano will exchange MIDI information with an external MIDI instrument or a personal computer.



Press the CHURCH ORGAN button while holding down the TOUCH and the TRANSPOSE buttons.



The display alternatively shows “Chn” (= Channel) and the channel number. The default channel is 1.

Use the VALUE buttons to change the channel number.

8. SENDING PROGRAM CHANGE NUMBERS

This function allows the CE200 piano to transmit program change numbers beyond the 20 pre-defined numbers transmitted by the sound select buttons. Using this function, you can send any number from 1 to 128.



Press the STRINGS button while holding down the TOUCH and the TRANSPOSE buttons.



The display alternatively shows “PG#” (= Program #) and a program change number. **Use the VALUE buttons to change the number.**

To send the program change number, press both VALUE buttons simultaneously.

9. LOCAL CONTROL ON/OFF

This determines whether the CE200 piano’s sound will be played from the piano’s keyboard (“ON”) or only from an external MIDI instrument (“OFF”).

Even with local control “off” the piano’s keyboard will still transmit to an external MIDI instrument or personal computer.



Press the HARPSI / MALLETS button while holding down the TOUCH and the TRANSPOSE buttons.



The display alternatively shows “LcL” (= Local) and on/off status. The default is on.

Use the VALUE buttons to toggle on and off.

10. TRANSMIT PROGRAM CHANGE ON/OFF

This determines whether or not the CE200 piano will transmit program change information when pressing the SOUND SELECT buttons. When this is turned on, pressing the SOUND SELECT buttons will send the program change numbers as listed in page 54.



Press the CHOIR / PAD button while holding down the TOUCH and the TRANSPOSE buttons.



The display alternatively shows “PGM” (= Program) and on/off status. The default is on.

Use the VALUE buttons to toggle on and off.

11. MULTI-TIMBRAL MODE ON/OFF

Multi-timbral mode allows the CE200 piano to receive data on more than one MIDI channel simultaneously. In this mode, the CE200 piano can play different musical parts with different sounds for each part.

Multi-Timbral On (On1 and On2)

This is a flexible 16 part multi-timbral setup. You can turn individual MIDI channels on and off, and assign any program number to any channel in the way you like. The CE200 piano’s normal program change numbers are assigned in On1 (Please see page 54 for a list of the program change numbers), and General MIDI program change numbers are assigned in On2.

Multi-Timbral Off

This turns off the multi-timbral capability. Only one MIDI channel will be active and only the preset sound currently selected will be heard when a MIDI signal is received.



Press the BASS / GUITAR button while holding down the TOUCH and the TRANSPOSE buttons.



The display alternatively shows “MLt” (= Multi) and on/off status. The default is off.

Use the VALUE buttons to toggle on1, on2 and off.

12. CHANNEL MUTE

This determines which MIDI channels are activated to receive MIDI information when the Multi-Timbral mode is set to on. You can activate or deactivate each of the 16 channels individually.



Press the **EFFECTS** button while holding down the **TOUCH** and the **TRANSPOSE** buttons.



The display alternatively shows “P01” (= Play 01) and “On”. This means channel 1 is activated.

Use the **VALUE** buttons to toggle on and off.

To turn on and off the other channels, use the **16 leftmost white keys to select a desired channel**. The display will show “P02” through “P16”. Then use the **VALUE** buttons to turn them on and off.

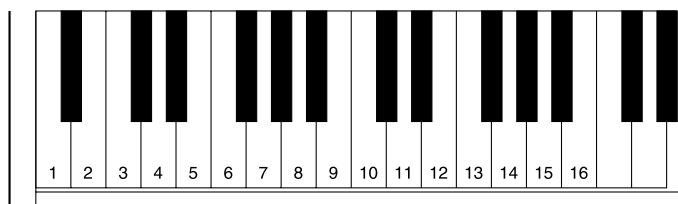

◆ NOTE

When the Multi-timbral mode is set to off, the “Channel Mute” function can not be selected.

13. LOWER PEDAL ON/OFF

This determines if the pedals will be active for lower sound when in **SPLIT** mode. The default setting is off which means the pedals are not active for lower sound.



Press the **REVERB** button while holding down the **TOUCH** and the **TRANSPOSE** buttons.



The display alternatively shows “LPd” (= Lower Pedal) and on/off status. The default is off.

Use the **VALUE** buttons to toggle on and off.

14. LAYER OCTAVE SHIFT

This allows the octave of the layered part to be shifted up or down when you use the dual function.



Press the SPLIT button while holding down the TOUCH and the TRANSPOSE buttons.



The display alternatively shows “LAo” (= Layer Octave) and a number which represents how many octaves the layered part is shifted up or down.

Use the VALUE buttons to set the desired layer octave shift range.

Layer Octave Shift can be set between -2 to 2.

15. LAYER DYNAMICS

In Dual mode sometimes simply adjusting the volume balance between the two layered sounds is not enough to create the desired sound character if both sounds are very dynamic. Two equally dynamic sounds can be difficult to control and play comfortably. The Layer Dynamics function allows you to limit the overall dynamic sensitivity of the layered sound to create a perfect blend between both sounds in a layer. In addition to reducing the volume of the layered sound, limiting the dynamic sensitivity of the layered sound also makes the layered sound easier to control in relation to the main sound as you play. With this function, you can comfortably play as dynamically as you like with the main sound while maintaining control of the layered sound.



Press the TEMPO button while holding down the TOUCH and the TRANSPOSE buttons.



The display alternatively shows “dyn” (= Dynamics) and a number which represents the level of dynamics.

Use the VALUE buttons to set the desired layer dynamics range.

You can select the level of dynamics from 1 to 10. A value of 1 produces the greatest reduction in dynamics and a value of 10 produces no change in the dynamics. The default value is 10.

16. DAMPER HOLD

This determines if the sound such as organ or strings should be held (on) or gradually decayed (off) when the damper pedal is depressed.

A digital display showing the characters 'dnp' in a white, monospace font on a black background.

Press the **BEAT** button while holding down the **TOUCH** and the **TRANSCOPE** buttons.

A digital display showing the characters 'off' in a white, monospace font on a black background.

The display alternatively shows “dMP” (= Damper) and on/off status. The default is off.

Use the **VALUE** buttons to toggle on and off.

17. USER MEMORY / FACTORY RESET

USER MEMORY

This function allows the CE200 piano to save the user-definable settings when the power is turned off. Once written to the memory, the saved settings will be recalled every time you turn the power on.

The following settings can be saved.

- : Sound type
- : Effects/Reverb/Voicing setting
- : Menu function settings
- : Transpose
- : Tempo, beat, and sound volume of the metronome

Press the **PLAY/STOP** button while holding down the **TOUCH** and the **TRANSCOPE** buttons.

A digital display showing the characters 'mem' in a white, monospace font on a black background.

The display alternatively shows “MEM” and “uSr”.

Press the **REC** button to execute the save operation.

The save operation is completed when the display shows "Wrt."

A digital display showing the characters 'uSr' in a white, monospace font on a black background.

A digital display showing the characters 'Wrt' in a white, monospace font on a black background.

When you are finished, press any one of the **SOUND SELECT** buttons to exit the menu.

FACTORY RESET

This function will appear only when the user memory function has been used. This function resets the CE200 piano to the factory settings. All parameters you saved in “User Memory” will be reset to the factory preset values.



Press the PLAY/STOP button while holding down the TOUCH and the TRANSPOSE buttons.

The display alternatively shows “MEM” and “rES”.

Press the REC button to restore factory settings, and exit the menu.

When the “User Memory” is saved, the display alternatively shows “MEM” and “rES” or “uSr”.

Use the VALUE buttons to select “rES”.

Press the REC button to restore factory settings, and exit the menu.



6. USING MIDI

In this chapter you will learn how you can create music by connecting the CE200 piano to an external MIDI device.

The CE200 piano is compatible with MIDI devices from Kawai and other manufacturers. It can also be used with sequencing software on a personal computer.

UNDERSTANDING MIDI

WHAT IS MIDI?

The letters MIDI stand for Musical Instrument Digital Interface, an international standard for connecting MIDI equipped synthesizers, drum machines, and other electronic instruments so that they can exchange data. Personal computers can also be equipped for MIDI communication. Electronic instruments equipped with MIDI can transmit and receive performance data such as, notes, what sound to play, pedal information, volume, etc. This data can be recorded with a device like a sequencer or a computer.

MIDI JACKS

The CE200 is equipped with two MIDI jacks for exchanging data: MIDI IN and MIDI OUT. These jacks are used to connect MIDI devices to one another using a special cable.

Each terminal has a different function.

IN : For receiving MIDI data from another MIDI instrument.

OUT : For sending MIDI data to another MIDI instrument.

Depending on how they are connected, instruments are grouped as those which receive data (producing sound when data is received from a connected instrument), those which send data (to instruments to which they are connected), and those which both send and receive data.

MIDI CHANNEL

MIDI uses what are known as “**channels**” as a means of routing MIDI data intended to play a specified instrument or specified part. By channelizing MIDI data, you can control multiple parts in multiple instruments with a single cable.

There are two aspects of channels, one for receiving and one for sending. The MIDI channel of the receiving instrument must be matched with the MIDI channel of the transmitting instrument. The idea is just like television or radio. If you have a desired station to watch or listen to, you need to

tune in to the right channel. When a transmitting instrument uses channel 1, the receiving instrument must be set to use channel 1 also. The CE200 piano lets you set the same channel number for both Transmit and receive. There are 16 MIDI channels available to choose from on the CE200 piano. In addition to channel-to-channel connection, it is possible to receive multiple channels. With MIDI instruments equipped with **multi-timbral capabilities**, you can receive multiple parts on multiple channels each played with a different sound simultaneously. For example, a MIDI instrument might receive the melody on channel 1, the chords on 2, the bass on 3, and assign a different instrument to each channel. Piano for channel 1, strings for 2, electric bass for 3. In this way, the CE200 piano can play up to 16 different parts each with a different sound.

Here's a diagram to summarize the MIDI connections we have discussed.

Instrument #1, which is transmitting the piano part on channel 1 (Ch 1), the string part on Ch 2 and the bass part on Ch 3, is connected to Instrument #2. Instrument #3 is connected to MIDI Thru on instrument #2. The receive channel is set to 1 for Instrument #2 and multi-timbral mode is turned off. On instrument #3 multi-timbral mode is on.

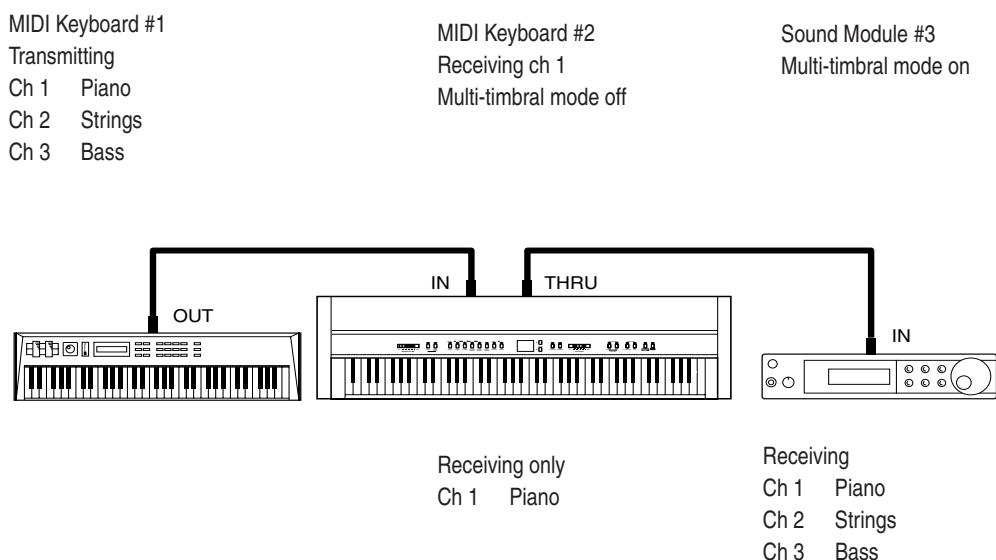

Instrument #2 recognizes only the piano part received from Instrument #1. Instrument #3 receives all the parts on the three channels being passed through Instrument #2 because Instrument #3's multi-timbral mode capability is activated.

We have provided this brief look at MIDI to help you understand the CE200 piano's MIDI capabilities.

While it is beyond the scope of this manual to explain the entire world of MIDI we do encourage you to visit your local music store or contact a music publisher for a listing of available books on MIDI applications to learn more.

Let's explore some MIDI applications using an external MIDI device connected to the CE200 piano.

6.1 USING THE CE200 PIANO AS CONTROLLER

First let's play sounds from an external MIDI device using the CE200 piano's keyboard.

MIDI CONNECTION

First, connect the CE200 piano's MIDI OUT jack to your external MIDI device's MIDI IN jack with a MIDI cable.

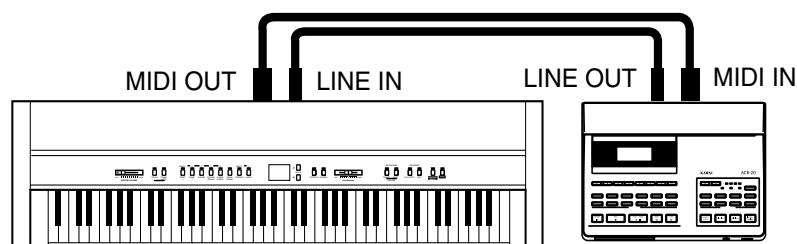

Next you must match the MIDI channel. The transmitting channel of the CE200 piano and receiving channel of your external MIDI device must be the same.

CHANGING TRANSMITTING CHANNEL

To change the transmit channel on the CE200 piano, **press the ELECTRIC PIANO button while holding down the TOUCH and the TRANSPOSE buttons.** The display alternatively shows "Chn" (= Channel) and the channel number. The default channel is 1. **Use the VALUE buttons to change the channel number.**

AUDIO CONNECTION

If your external MIDI device is not equipped with an amplifier or speakers, you can connect it directly to the CA piano using the LINE IN jacks or to an external sound system.

Connect the LINE IN jacks of the CA piano and the LINE OUT (audio output) jacks of your external MIDI device with a pair of audio cables (see the illustration above). Now you will be able to hear the CE200 piano's sound and your external MIDI device's sound together through the CE200's speakers. Use the volume control on your external MIDI device to balance it's volume with the CE200 piano.

Now You're ready to play.

Play the CE200 piano's keyboard. You should hear both instruments as you play. What is happening is that the CE200 piano is transmitting MIDI information, what note you played, how hard (loud) you played it, and so on to your external MIDI device. The external MIDI device reproduces sound based on this information using its own sound module.

PROGRAM CHANGE

Press a SOUND SELECT button on the CE200. You will hear the sound on your external MIDI device also changes. Pressing a SOUND SELECT button lets the CE200 piano transmit a **“program change”** number. A program change is the type of MIDI command that tells the receiving instrument what sound or instrument to play your notes with.

Actual program change information is just a number, from 1 to 128, not an instrument name. You select the desired instrument with a specific number. Not all MIDI instruments assign the same sound to the same program change number. MIDI instruments that conform to the General MIDI (GM) standard however “DO” assign the same sound to the same program change number. For example program change #1 will always be an acoustic piano sound on a “GM” compatible synth, and program change #33 will always be an acoustic bass sound. Because of this, when connecting two “GM” instruments together, selecting the right sound is not a problem. The CE200 piano is not a General MIDI instrument and its internal sounds do not conform to the General MIDI standard. This means when you select a sound on the CE200 piano such as Classic E. Piano you will probably hear a different sound playing from your external MIDI device. What sound you hear will depend on the sound assignments on your external MIDI device. Below is a chart of the Program Change number/sound assignment mapping for the first twelve CE200 piano sounds and the first twelve “GM” sounds. Please see page 54 for more detail. The CE200 piano can have different mappings

depending on the setting for multi-timbral mode (explained later in this chapter).

Program #	CE200	General MIDI
1	Concert Grand	Grand Piano
2	Studio Grand	Bright Piano
3	Mellow Grand	Electric Grand
4	Classic E. Piano	Honky Tonk Piano
5	Modern E. P	Electric Piano 1
6	Jazz Organ	Electric Piano 2
7	Drawbar Organ	Harpsichord
8	Church Organ	Clavi
9	Diapason	Celesta
10	String Ensemble	Glockenspiel
11	Slow Strings	Music Box
12	Harpsichord	Vibraphone

In order for your external MIDI device to play the sound you want, you need to know what program change number to transmit to it. Please read your external MIDI device's manual for a list of its program change number/sound assignments. Then read "Sending Program Change Numbers" on page 54 for the procedure to send a desired program change number from the CE200 piano.

That is how to layer the CE200 piano's sound with a desired sound from an external MIDI device.

LOCAL CONTROL

You may want to play and only hear your external MIDI device's sound, without the CE200 piano's sound. You can turn off the CE200 piano's sound using a function called "local control".

Local control determines whether or not the CE200 piano will produce a sound when you play it's own keyboard. When local control is on, the CE200 piano produces sound as you play the keys. When off, the piano will not produce a sound when you play the keys. The CE200 piano's keyboard will however, continue to transmit MIDI information to an external MIDI device.

Press the CHURCH ORGAN button while holding down the TOUCH and the TRANSPOSE buttons, and the piano will show "on" or "off" in the display. The initial value is on. Toggle on and off using the VALUE buttons.

Play the keyboard and you will hear only the sound from your external MIDI device.

To change the sound from the CE200 piano, select the desired number as explained in the Reference section and send it from the CE200 piano to your external MIDI device.

It may be possible to change preset sounds directly on your external MIDI device. In this case you may want to set the CE200 piano so that it does not transmit program changes. Read “10. Transmit Program Change On/Off” on page 37 to learn how to prevent the CE200 piano from transmitting program changes.

6.2 USING THE CE200 PIANO AS A MULTI-TIMBRAL SOUND MODULE

The CE200 piano can also be used as a 16-part multi-timbral sound module. Your CE200 piano is capable of playing back for example, a four part song with two piano parts, a string part, and a choir part all sent from an external MIDI sequencer or a personal computer. You can also play the CE200 piano along with a recorded song.

To set the CE200 piano to receive MIDI as a multi-timbral instrument it must be connected with an external MIDI device or personal computer with appropriate software.

Connect the CE200 piano’s MIDI IN jack and your external MIDI device’s MIDI OUT jack with a MIDI cable. Please note that the MIDI information is now being transmitted the opposite of our earlier setup. The CE200 piano is now receiving MIDI data from your external MIDI device.

MIDI CHANNEL

The next step is to match your MIDI channels. When receiving MIDI data on the CE200 piano with multi-timbral mode ON, it is not necessary to specify a MIDI channel to use because the CE200 piano can receive data on multiple MIDI channels at once. You do have to be careful to match MIDI channels between each part. A MIDI channel can only have one sound assigned to it at a time. You must set the MIDI channel for each part on both the transmitting (external MIDI device) and the receiving (CE200 piano) MIDI devices. For example, channel 1 for piano, ch 2 for strings, ch 3 for choir, etc.

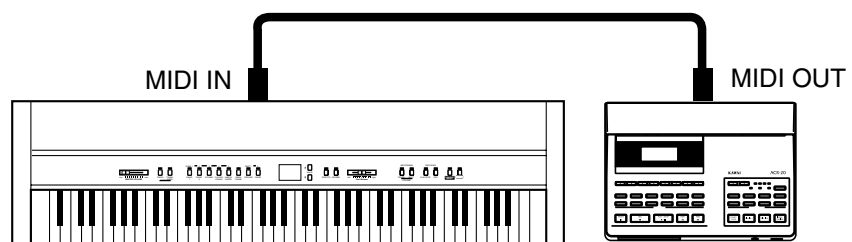

MULTI-TIMBRAL MODE

Multi-timbral On is a setup for 16-channel multi-timbral operation. You can mute the channels separately. Each channel recognizes the program change numbers as listed on page 54. There are two kinds of Multi-timbral On. On1 and On2 have different program change numbers assigned.

Multi-timbral Off turns off the multi-timbral capability. If you would like to have the CE200 piano receive MIDI data on a single channel and ignore all data on the other channels set multi-timbral to “Off”. Remember, if you want the CE200 piano to receive MIDI information from an external device, in this setup you must match the receiving channel with the transmitting channel. Program change numbers are recognized as listed on page 54.

To demonstrate the multi-timbral capability of the CE200 piano, let's choose Multi-timbral On.

Press the BASS / GUITAR button while holding down the TOUCH and the TRANSPOSE buttons.

Use the VALUE buttons to select Multi-timbral On. The display will read “On1” or “On2”.

Let's see how this works using an external MIDI device. If you have a keyboard connected to the CE200 piano try playing some notes. You should hear the CE200 piano as you play. If you have a MIDI song player or personal computer with MIDI software connected try sending some MIDI song data with one or more different musical parts to the CE200. Again you should hear the CE200 piano playing all the parts. In multi-timbral mode, if you want to hear a particular sound for each part you transmit to the CE200 you must send the correct Program/sound number from the transmitting MIDI device to the CE200 piano. Please see page 54 for a list of the Program/sound number assignments for the CE200 piano.

If you own a “GM” sound module you'll probably want to use it as your multi-timbral module instead of the CE200 piano. If you have a hardware sequencer or personal computer but do not own another sound module, you can enjoy sixteen-part multi-timbral capability with only the CE200 piano.

MIDI may seem a little difficult to work with at first, but once mastered it offers many new and exciting ways to enjoy music.

While this manual avoids going into too much detail regarding the technical aspects of MIDI such as “system exclusive data”, for those who are more familiar with MIDI or want to be, this manual provides technical MIDI information and a MIDI Implementation Chart, on page 58 and 59.

7. JACKS

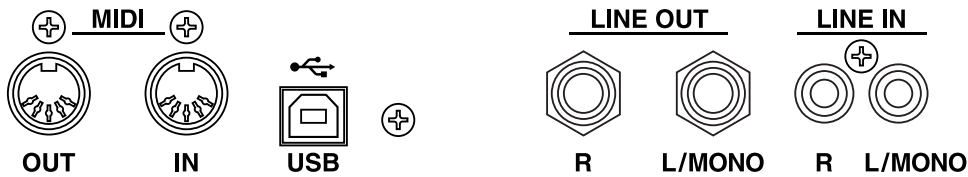

MIDI JACKS

These jacks are used to connect external MIDI devices with the CE200 piano.

There are two terminals: MIDI IN and MIDI OUT.

USB JACK

This jack is used to connect with a personal computer and exchange MIDI data.

When the CE200 piano is connected to a computer via a commercially available USB cable, the CE200 piano will be recognized as a MIDI device. As with a regular MIDI interface, the CE200 piano will be able to transmit and receive MIDI messages.

There are A USB port and B USB port. Connect a computer to the A port and digital piano to the B port.

ABOUT A USB DRIVER

For data exchange between a computer and digital piano via USB connection, software (USB-MIDI driver) must be installed on the computer for proper digital piano operations.

Please read the following instructions carefully as a different USB-MIDI driver may be necessary depending on the computer OS.

Windows XP / Me users:

The standard USB-MIDI driver installed on Windows will be used. This USB-MIDI driver will be automatically installed when the unit is connected to the computer.

To establish MIDI communications with the unit by using an application, select "USB audio device" to define the unit as a MIDI device.

Windows 2000 / 98SE users:

You need to install the specified, special USB-MIDI driver. Download the special USB driver from the KAWAI site as shown below, and install it on the computer.

http://www.kawai.co.jp/download_demo/driver/

Read the instruction manual thoroughly before connecting the unit to the

computer, and make sure to install the driver. If you connect the unit to the computer without installing the driver, the USB-MIDI driver may not operate properly. If this occurs, use the driver update function of the OS to install the appropriate USB-MIDI driver, or delete the driver by using the driver delete function and then install the driver again.

To establish MIDI communications with the unit by using an application, select "KAWAI USB MIDI IN" and "KAWAI USB MIDI OUT" to define the unit as a MIDI device.

Macintosh OS X users:

When the unit is used with Macintosh OS X, the unit will be recognized as a MIDI device automatically; therefore, no special driver is needed.

To establish MIDI communications with the unit by using an application, select "USB-MIDI" to define the unit as a MIDI device.

Users of Macintosh OS9 or earlier:

The unit does not support Macintosh OS9 or earlier. Please establish a MIDI connection by using a commercially available MIDI interface.

NOTES ON USB

When MIDI and USB are connected simultaneously, USB will be prioritized.

When connecting a digital piano to a computer by using a USB cable, first connect the cable and then turn on the power of the digital piano.

When a digital piano is connected to a computer by using a USB cable, it may take some time before communications start.

When a digital piano and a computer are connected via a hub, and the operation is not stable, connect the digital piano directly to the USB port of the computer.

Operations of a computer or a digital piano may become unstable if the power of the piano is turned on or off, or if the USB cable is pulled out or inserted during:

- : Driver installation
- : Computer power-up
- : MIDI application operations
- : Communication with the computer
- : Standby in power-saving mode

*USB may not operate properly depending on the settings of your computer. Read the computer instruction manual thoroughly before use and ensure that appropriate settings are made.

*Windows is a registered trademark of Microsoft Corporation.

*Macintosh is a registered trademark of Apple Computer, Inc.

*Other company names and product names mentioned referenced herein may be registered trademarks or trademarks of re-spective owners.

LINE OUT JACKS

These jacks provide stereo output of the piano's sound to amplifiers, tape recorders or similar equipment.

The audio signal coming through the LINE IN jacks is also routed to these jacks. The piano's sound is mixed with the LINE IN signals.

The CE200 piano's VOLUME slider can control the output level of its own sound while it does not control the LINE IN signal.

LINE IN JACKS

These jacks are used to connect a pair of stereo outputs from other audio equipment or electronic instruments to the piano's speakers.

The audio signal coming through these jacks bypasses the piano's volume control. To adjust the volume level, use the output control of the external device.

HEADPHONE JACKS

There are two jacks for headphones provided at the left end on the bottom of the piano.

You can hear the piano's sound as well as any audio signal that is coming through the LINE IN.

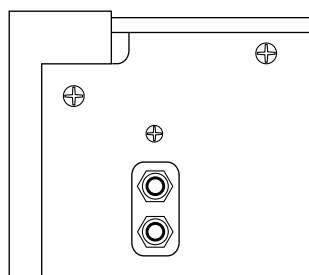

BOTTOM VIEW



8. APPENDICES

PROGRAM CHANGE NUMBER MAPPING

Sound Button		Sound Name	Multi-Timbral mode			
			Off, On 1 Prog #	Bank MSB	On 2 Bank LSB	Prog #
PIANO	1	Concert Grand	1	121	0	1
	2	Studio Grand	2	121	1	1
	3	Mellow Grand	3	121	2	1
ELECTRIC PIANO	1	Classic E.Piano	4	121	0	5
	2	Modern E.P.	5	121	0	6
DRAWBAR	1	Jazz Organ	6	121	0	18
	2	Drawbar Organ	7	121	0	17
CHURCH ORGAN	1	Church Organ	8	121	0	20
	2	Diapason	9	95	7	20
STRINGS	1	String Ensemble	10	121	0	49
	2	Slow Strings	11	95	1	45
HARPSI & MALLETS	1	Harpsichord	12	121	0	7
	2	Harpsichord Oct	13	121	1	7
	3	Vibraphone	14	121	0	12
CHOIR & PAD	1	Choir	15	121	0	53
	2	New Age Pad	16	121	0	89
	3	Atmosphere	17	121	0	100
BASS & GUITAR	1	Wood Bass	18	121	0	33
	2	Electric Bass	19	121	0	34
	3	Finger Nylon Gt.	20	95	4	25

RHYTHM STYLE LIST

1.	8 Beat 1	11.	Ballad 2	21.	Waltz
2.	8 Beat 2	12.	Light Ride 1	22.	Motown 1
3.	16 Beat 1	13.	Light Ride 2	23.	Motown 2
4.	16 Beat 2	14.	Smooth Beat	24.	Ride Swing
5.	16 Beat 3	15.	Slow Jam	25.	H.H. Swing
6.	Ride Beat 1	16.	Funky Beat	26.	Jazz Waltz
7.	Ride Beat 2	17.	Disco	27.	H.H. Bossa Nova
8.	Rock Beat	18.	8 Shuffle	28.	Mambo
9.	Surf Rock	19.	Triplet	29.	Light Samba
10.	Ballad 1	20.	Triplet Ballad	30.	Surdo Samba

PIANO MUSIC LIST

Tambourin	J.P. Rameau
The harmonious blacksmith	G.F. Händel
Menuette BWV. Anh.114	J.S. Bach
Menuette BWV. Anh.115	J.S. Bach
Menuette BWV. Anh.116	J.S. Bach
Le Coucou	L.C.Daquin
Gavotte	F.J. Gossec
Menuett	L. Boccherini
Thema und Variationen <Sonate für Klavier No.11 K.331(300i)>.....	W.A. Mozart
Türkischer Marsch <Sonate für Klavier No.11 K.331(300i)>.....	W.A. Mozart
Menuett	W.A. Mozart
Sonate für Klavier No.14 “Mondschein”	L.v. Beethoven
Sonate für Klavier No.8 “Pathétique”	L.v. Beethoven
Für Elise	L.v. Beethoven
Rondo favori	J.N. Hummel
Impromptu op.90-4	F.P. Schubert
Moments musicaux op.94-3	F.P. Schubert
Entr’ acte	F.P. Schubert
Impromptu op.142-3	F.P. Schubert
Auf Flügeln des Gesanges.....	F. Mendelssohn
Frühlingslied	F. Mendelssohn
Rondo Capriccioso	F. Mendelssohn
Chanson de l’adieu	F.F. Chopin
Raindrop	F.F. Chopin
Petit chien.....	F.F. Chopin
Nocturne No.2	F.F. Chopin
Fantaisie-Impromptu	F.F. Chopin
Polonaise No.3 “Militaire”.....	F.F. Chopin
Polonaise No.6 “Héroïque”	F.F. Chopin

FRONT PANEL

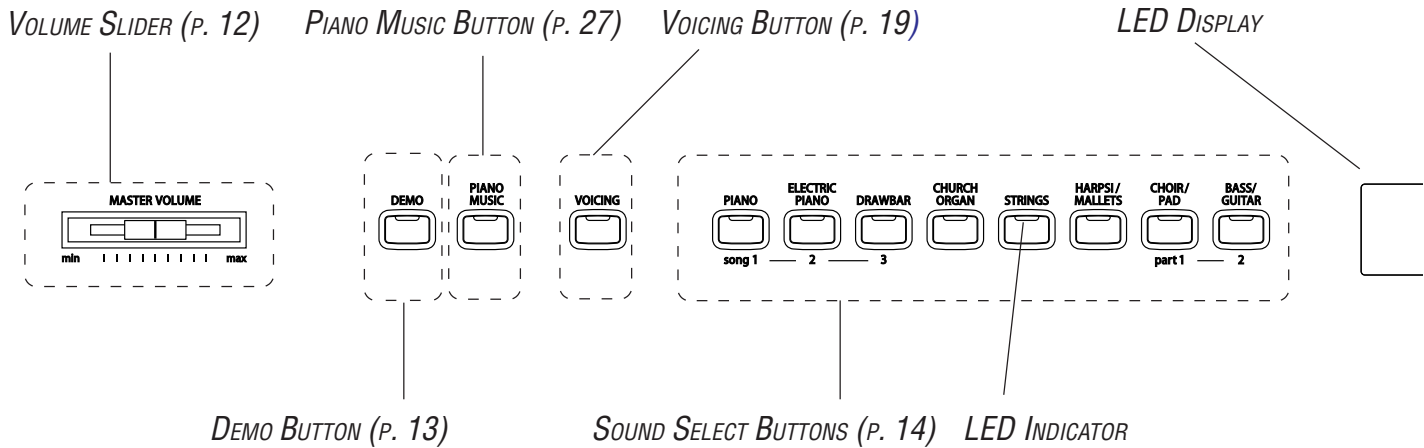

SOUND DEMO SONG LIST

PIANO	Concert Grand	Valse Romantique / Debussy
	Studio Grand	Original
	Mellow Grand	La Fille aux Cheveux de Lin / Debussy
ELECTRIC PIANO	Classic E.Piano	Original
	Modern E.P.	Original
DRAWBAR	Jazz Organ	Original
	Drawbar Organ	Original
CHURCH ORGAN	Church Organ	Toccata / Eugene Gigout
	Diapason	Wohl mir, daß ich Jesum habe / Bach
STRINGS	String Ensemble	Le quattro stagioni La primavera / Vivaldi
	Slow Strings	Original
HARPSI&MALLETS	Harpsichord	French Suite No. 6 / Bach
	Harpsichord Oct.	Prelude A / Bach
	Vibraphone	Original
CHOIR & PAD	Choir	Original
	New Age Pad	Original
	Atmosphere	Original
BASS	Wood Bass	Original

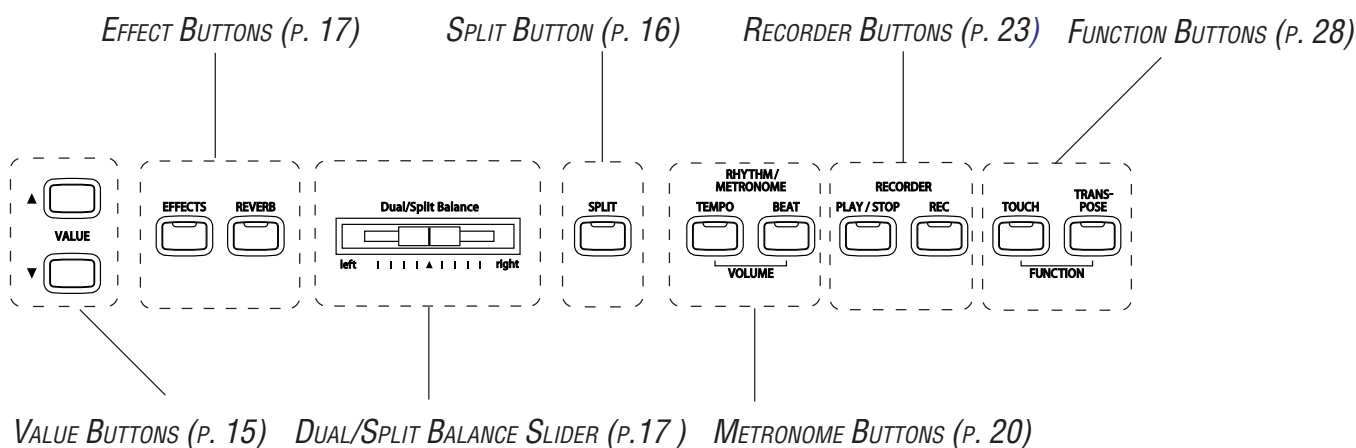

SPECIFICATIONS

	CE200
Keyboard	88 Wooden Keyboard
Polyphony	Maximum 96
Number of Sound	20
Sound Catrgories	Piano, Electric Piano, Drawbar, Church Organ, Strings, Harpsi & Mallets, Choir & Pad, Bass & Guitar
Effects	Reverb (5), Chorus, Delay, Tremolo, Rotary (2)
Temperaments	Equal (Piano Only), Mersenne pure (Major), Mersenne pure (minor), Pythagorea, Meantone, Werckmeister III, Kirnberger III, Equal (flat), Equal
Recorder	2 Tracks, 3 Songs The total memory capacity of the recorder is approximately 15,000 notes.
Other Features	Piano Music (29 Preset Musics), Volume, Dual, Split, Four Hands, Dual/Spilt Balance, Voicing, Rhythm Metronome, Transpose, Brilliance, Tune, Damper Resonance, String Resonance, Layer Dynamics, Lower Octave Shift, Layer Octave Shift, User Memory, Factory Reset, Touch Curve (Light 1 Light 2, Normal, Heavy 1, Heavy 2, Off, User), Lower Pedal, MIDI (16 part multi-timbral capability)
Pedals	Sustain, Sostenuto, Soft
Jacks	Headphone (2), LINE IN (L, R), LINE OUT (L/MONO, R), MIDI (IN, OUT), USB
Output Power*	20W x 2
Speakers	12 cm x 2
Power Consumption	55 W
Finish	Rosewood
Dimensions (WxDxH) (without Music Rack)	1386 x 505 x 873 mm 55" x 20" x 34"
Weight (without bench)	62 kg, 137LB's

*EIAJ

MIDI EXCLUSIVE DATA FORMAT



- 1 F0..... Start code
- 2 40..... Kawai's ID number
- 3 00 - 0F MIDI channel
- 4 10, 30..... Function code (30 when setting MULTI TIMBRE ON/OFF)
- 5 04..... Indicates that the instrument is Electronic Piano
- 6 02..... Indicates that the piano is one of CE200.
- 7 data 1
- 8 data 2 (See the table below.)
- 9 data 3
- 10 F7..... End code

data 1	data 2	data 3	Function
00	00	—	Multi Timbre Off
00	01	—	Multi Timbre On 1
00	02	—	Multi Timbre On 2
0D	00–07	—	00: Effect Off, 01: Chorus, 02: Delay 1, 03: Delay 2, 04: Delay 3, 05: Tremolo, 06: Rotary 1, 07: Rotary 2
0E	00–03, 06, 07	—	00: Reverb Off, 01: Room 2, 02: Stage, 03: Hall 1, 06: Room 1, 07: Hall 2
14	00–7F	—	Dual/Split balance
16	1F–60	—	Tune, 40: 440 Hz
17	00, 7F	—	00: Program Change Off, 7F: Program Change On
18	00–07	—	00: Light 1, 01: Normal, 02: Heavy 1, 03: Off, 04: Light 2, 05: Heavy 2, 06: User
19	00–03	—	Lower Octave Shift
20	00–27	00–27	Dual, data 2: Right sound, data 3: Left sound
21	00–27	00–27	Split, data 2: Upper sound, data 3: Lower sound
25	00–08	00–0B	data 2: Temperament, data 3: Key
26	00, 7F	00–0F	Multi Timbre, data 2: 00 (On), 7F (Off), data 3: channel

MIDI IMPLEMENTATION CHART

KAWAI DIGITAL PIANO MODEL: CE200

DATE: JANUARY 2007

VERSION 1.0

Function		Transmit	Receive	Remarks
Basic	Default	1	1	
Channel	Changes	1 – 16	1 – 16	
Mode	Default	3	3	* The default for the OMNI mode is ON. Specifying MIDI channels automatically turns it OFF.
	Messages	×	1, 3*	
	Altered	*****		
Note		9 – 120**	0–127	
Number	True voice	*****	0–127	
Velocity	Note ON	○ 9nH v=1–127	○	
	Note OFF	× 9nH v=0	×	
After	Key's	×	×	
Touch	Ch's	×	×	
Pitch Bend		×	×	
	0, 32	○	○	Bank Select
	7	×	○	Volume
	11	×	○	Expression pedal
	64	○ (Right pedal)	○	Sustain pedal
Control	66	○ (Center pedal)	○	Sostenuto pedal
Change	67	○ (Left pedal)	○	Soft pedal
Program		○ 0 – 127	○***	*** See the Program Change Number Mapping in page 54.
Change	:True #	*****		
System Exclusive		○	○	On/Off Selectable
Common	: Song Position	×	×	
	: Song Select	×	×	
	: Tune	×	×	
System	: Clock	×	×	
Real Time	: Commands	×	×	
Aux	: Local On/Off	×	○	
	: All Notes Off	×	○ (123-127)	
	: Active Sense	○	○	
	: Reset	×	×	
Notes		** The value depends on the Transpose setting.		

Mode 1: OMNI ON, POLY

Mode 2: OMNI ON, MONO

○: Yes

Mode 3: OMNI OFF, POLY

Mode 4: OMNI OFF, MONO

×: No

KAWAI

CE200 Owner's Manual
OW996E-C0701
Printed in Indonesia
815847
KPSZ-0181

Copyright ©2006 Kawai Musical Instruments Mfg. Co., Ltd. All rights reserved.

Eng