

**KAWAI**

---

---

**Digital Piano**  
**CA1200**  
**CA1000**

---

---

**Owner's Manual**

# Important Safety Instructions

## SAVE THESE INSTRUCTIONS

INSTRUCTIONS PERTAINING TO A RISK OF FIRE, ELECTRIC SHOCK, OR INJURY TO PERSONS



**WARNING**  
TO REDUCE THE RISK OF FIRE OR ELECTRIC SHOCK, DO NOT EXPOSE THIS PRODUCT TO RAIN OR MOISTURE.

**AVIS : RISQUE DE CHOC ELECTRIQUE - NE PAS OUVRIR.**

TO REDUCE THE RISK OF ELECTRIC SHOCK, DO NOT REMOVE COVER (OR BACK). NO USER-SERVICEABLE PARTS INSIDE. REFER SERVICING TO QUALIFIED SERVICE PERSONNEL.



The lightning flash with arrowhead symbol, within an equilateral triangle, is intended to alert the user to the presence of uninsulated "dangerous voltage" within the product's enclosure that may be of sufficient magnitude to constitute a risk of electric shock to persons.



The exclamation point within an equilateral triangle is intended to alert the user to the presence of important operating and maintenance (servicing) instructions in the literature accompanying the product.

### Examples of Picture Symbols



denotes that care should be taken. The example instructs the user to take care not to allow fingers to be trapped.



denotes a prohibited operation. The example instructs that disassembly of the product is prohibited.



denotes an operation that should be carried out. The example instructs the user to remove the power cord plug from the AC outlet.

Read all the instructions before using the product.

**WARNING - When using electric products, basic precautions should always be followed, including the following.**



**WARNING** Indicates a potential hazard that could result in death or serious injury if the product is handled incorrectly.

The product should be connected to an AC outlet of the specified voltage.



- If you are going to use an AC power cord, make sure that its has the correct plug shape and conforms to the specified power voltage.
- Failure to do so may result in fire.

Do not insert or disconnect the power cord plug with wet hands.



Doing so may cause electric shock.

The chair must be used properly(it must be used only when playing the product).

- Do not play with it or stand on it.
- Only one person is allowed to sit on it.
- Do not sit on it when opening the lid.

Doing so may cause the chair to fall over or your fingers to be trapped, resulting in injury.

When using the headphones, do not listen for long periods of time at high volume levels.

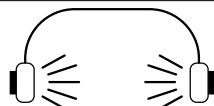

Doing so may result in hearing problems.

Do not lean against the keyboard.



Doing so may cause the product to fall over, resulting in injury.

Do not disassemble, repair or modify the product.



Doing so may result in product breakdown, electric shock or short-circuit.

When disconnecting the AC power cord's plug, always hold the plug and pull it to remove it.



● Pulling the AC power cord itself may damage the cord, causing a fire, electric shock or short-circuit.

If the product will not be used for a long time, unplug the AC power cord from the AC outlet.



● Failure to do so may cause fire in case of lightning.  
● Failure to do so may over-heat the product, resulting in fire.

This product may be equipped with a polarized line plug (one blade wider than the other). This is a safety feature. If you are unable to insert the plug into the outlet, contact an electrician to replace your obsolete outlet. Do not defeat the safety purpose of the plug.

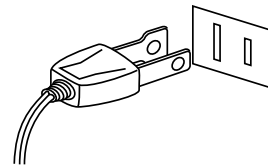

## CAUTION

Indicates a potential hazard that could result in injury or damage to the product or other

Do not use the product in the following areas.

- Areas, such as those near windows, where the product is exposed to direct sunlight
- Extremely hot areas, such as near a heater
- Extremely cold areas, such as outside
- Extremely humid areas
- Areas where a large amount of sand or dust is present
- Areas where the product is exposed to excessive vibrations

Using the product in such areas may result in product breakdown.

When you close the keyboard cover, close it gently.



Closing it roughly may trap your fingers, resulting in injury.

Before connecting cords, make sure that the power to this product and other devices is turned OFF.



Failure to do so may cause breakdown of this product and other devices.

Take care not to allow any foreign matter to enter the product.

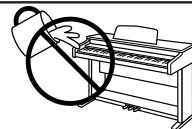

Entry of water, needles or hair pins may result in breakdown or short-circuit.

Do not drag the product on the floor. Take care not to drop the product.



Please lift up the product when moving it. Please note that the product is heavy and must be carried by more than two persons. Dropping the product may result in breakdown.

Do not place the product near electrical appliances such as TVs and radios.

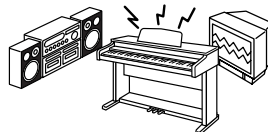

● Doing so may cause the product to generate noise.  
● If the product generates noise, move the product sufficiently away from the electrical appliance or connect it to another AC outlet.

When connecting the AC power cord and other cords, take care not to get them tangled.



Failure to do so may damage them, resulting in fire, electric shock or short-circuit.

**Do not wipe the product with benzene or thinner.**



- Doing so may result in discoloration or deformation of the product.
- When cleaning the product, put a soft cloth in lukewarm water, squeeze it well, then wipe the product.

**Do not stand on the product or exert excessive force.**



- Doing so may cause the product to become deformed or fall over, resulting in breakdown or injury.

**The product should be located so that its location or position does not interfere with its proper ventilation.**

**This product should be used only with the stand that is provided by the manufacturer.**

**The product should be serviced by qualified service personnel when:**

- The power supply cord or the plug has been damaged.
- Objects have fallen, or liquid has been spilled into the product.
- The product has been exposed to rain.
- The product does not appear to operate normally or exhibits a marked change in performance.
- The product has been dropped, or the enclosure damaged.

### **Notes on Repair**

Should an abnormality occur in the product, immediately turn the power OFF, disconnect the power cord plug, and then contact the shop from which the product was purchased.

- **This digital piano is for household use and is not intended for commercial use.**

### **CAUTION:**

To prevent electric shock, match wide blade of plug to wide slot, fully insert.

### **ATTENTION:**

Pour éviter les chocs électriques, introduire la lame la plus large de la fiche dans la borne correspondante de la prise et pousser jusqu'au fond.

### **Instruction for AC power cord (U.K.)**

Do not plug either terminal of the power cord to the ground of the AC outlet on the wall.

### **FCC Information**

This equipment has been tested and found to comply with the limits for a Class B digital device, pursuant to Part 15 of the FCC Rules. These limits are designed to provide reasonable protection against harmful interference in a residential installation. This equipment generates, uses and can radiate radio frequency energy and, if not installed and used in accordance with the instructions, may cause harmful interference to radio communications.

If this equipment does cause harmful interference to radio or television reception, which can be determined by turning the equipment off and on, the user is encouraged to try to correct the interference by one or more of the following measures:

- Reorient or relocate the receiving antenna.
- Increase the separation between the equipment and receiver.
- Connect the equipment into an outlet on a different electrical circuit from the receiver.
- Consult the dealer or an experienced radio/TV technician for help.

### **Canadian Radio Interference Regulations**

This instrument complies with the limits for a class B digital apparatus, pursuant to the Radio Interference Regulations, C.R.C., c. 1374.

## **THANK YOU FOR PURCHASING A KAWAI DIGITAL PIANO!**

The Kawai digital piano is a revolutionary new keyboard instrument that combines the latest in electronic advances with traditional craftsmanship inherited from Kawai's many years of experience in building fine pianos. Its keyboard provides the touch response and full dynamic range required for a superb performance on the piano, harpsichord, organ, and other instruments. In addition, the CA piano is equipped with reverb and a digital effect processor for an even fuller sound. Industry-Standard MIDI (Musical Instrument Digital Interface) jacks are included which allow you to play other electronic instruments at the same time—opening a whole new world of musical possibilities.

This Owner's Manual contains valuable information that will help you make full use of this instrument's many capabilities.

There are two main sections in the manual. One is the Tutorial section and the other is a Reference section. The tutorial section explains the basic features of the CA piano. Read this section first if this is your first digital piano. The reference section describes the operation and uses of each of the panel components—buttons, sliders, and jacks. If you are familiar with digital pianos, you may want to start with this section. Please read all sections carefully and keep this manual handy for further reference.

# READ ME FIRST (CA1000)

Before beginning the assembly of your CA1000 read and become familiar with the assembly instructions that follow. Then, carefully unpack the piano and check your unit against the parts list.

## PARTS PROVIDED

Side Panel (A)	2 pcs.
Back Board (B)	1 pc.
Pedal Board (C)	1 pc.
Speaker Cover (D)	1 pc.
Screw E (M6 x 25)	8 pcs.
Screw F (M4 x 15)	8 pcs.
Screw G (ø4 x 20)	4 pcs.
Adjuster (H)	1 pc.

M6 x 25

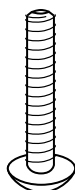

(E)

M4 x 15

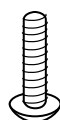

(F)

ø4 x 20

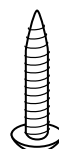

(G)

Adjuster

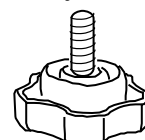

(H)

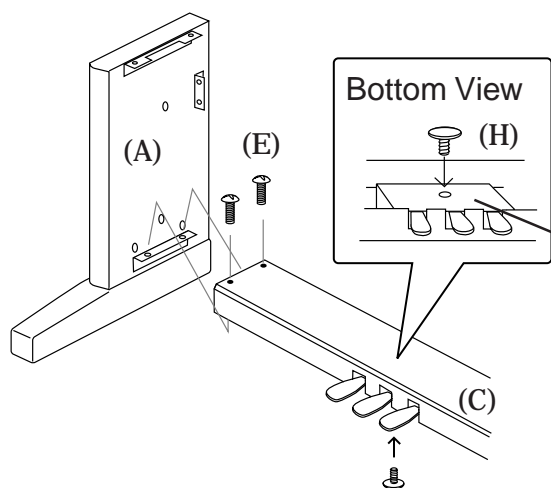

1. Insert the Adjuster (H) on the Pedal Unit.
2. Fasten the Side Panels (A) and the Pedal Board (C) with four screws (E).

3. Hold Back Board (B) behind the Pedal Board (C) and in front of the fixing metal of the Side Panels (A).

4. Fasten the Side Panels (A) and Back Board (B) with four screws (F).

5. Fasten the Pedal Board (C) and Back Board (B) with four screws (G).

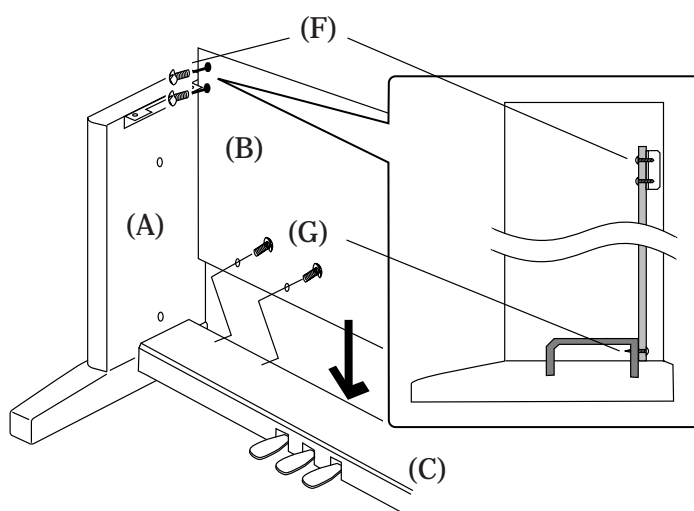

**CAUTION:**

To prevent personal injury, do not handle the main unit from the ends.

**6.** The next step requires one person on each end of the main unit. Grasp the unit with both hands, one under the front, the other under the rear (remember, not the end) and carefully center the main unit on top of the stand so that the hook brackets located on the bottom rear of the main unit are inside the stand side panels (A) and approximately one-third of the rear, top edge of the side panels are exposed. (See the illustration to the right)

**7.** Maintaining a firm grasp under the front of the main unit slide it toward the rear of the stand until the hook brackets engage the brackets at the rear top of the side panels (A). This hook arrangement is design to prevent the main unit from tilting forward while the screws are installed. Keep one hand under the front of the main unit, push down on the front to be certain that hooks are properly engaged.

**8.** Fasten the main unit and the stand with four screws (E).

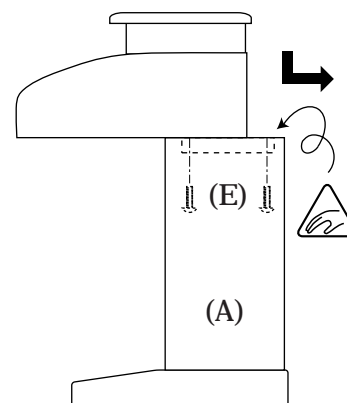

**CAUTION:**

Be sure to secure the main unit to the stand with the screws. If you fail to do so, the unit could fall from the stand causing damage or personal injury.

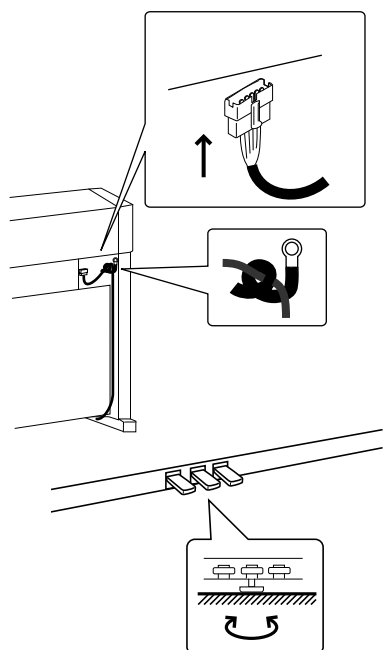

**9.** Attach the Speaker Cover (D) in front of the speaker boxes with four screws (F).

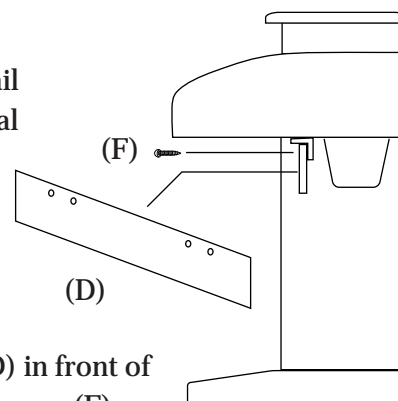

**10.** Insert the pedal connection cord that comes from Pedal Board into the main unit's pedal jack and fix with the clamp of the Side Panel.

**11.** Turn the adjuster (installed on the bottom of the Pedal Unit) down until it makes firm contact with the floor. If the floor is carpeted, place a spiked furniture cup under the adjuster so that it makes firm contact with the carpet backing. Press any pedal with your foot. If the pedal rail flexes, lower the adjuster until flexing is minimized.

**CAUTION:**

Before moving your piano, turn the adjuster up so that it clears the floor.

# READ ME FIRST (CA1200)

Before beginning the assembly of your CA1200 read and become familiar with the assembly instructions that follow. Then, carefully unpack the piano and check your unit against the parts list.

## PARTS PROVIDED

End Panel (A)	2 pcs.	Screw H (M6 x 25)	8 pcs.
Side Panel (B)	2 pcs.	Screw I (M4 x 30)	4 pcs.
Back Board (C)	1 pc.	Screw J (M4 x 15)	4 pcs.
Front Panel (D)	1 pc.	Screw K (ø4 x 20)	10 pcs.
Pedal Board (E)	1 pc.	Screw L (ø4 x 12)	1 pc.
Speaker Box (F)	2 pcs.	Cord Clamp (M)	1 pc.
Screw G (M6 x 40)	8 pcs.	Adjuster (N)	1 pc.

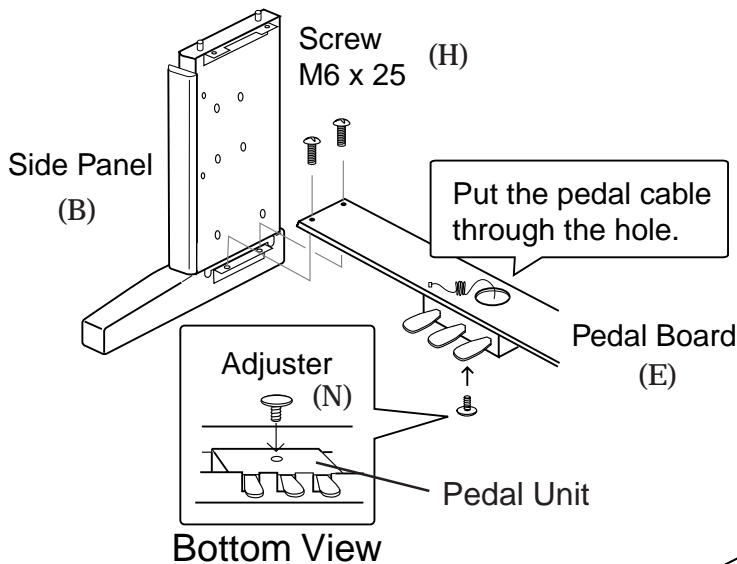
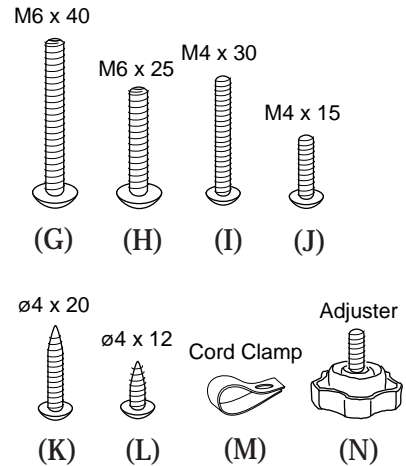

1. Insert the Adjuster (N) on the Pedal Unit.
2. Fasten the Side Panels (B) and the Pedal Board (E) with four screws (H).
3. Untie the pedal cable on the bottom of Pedal Board (E) and put it through the hole of the Pedal Board (E).

4. Put the Front Panel (D). First, fasten the Side Panels (B) and the Front Panel (D) with four screws (I).
5. Then fasten the Pedal Board (E) and the Front Panel (D) with four screws (J).

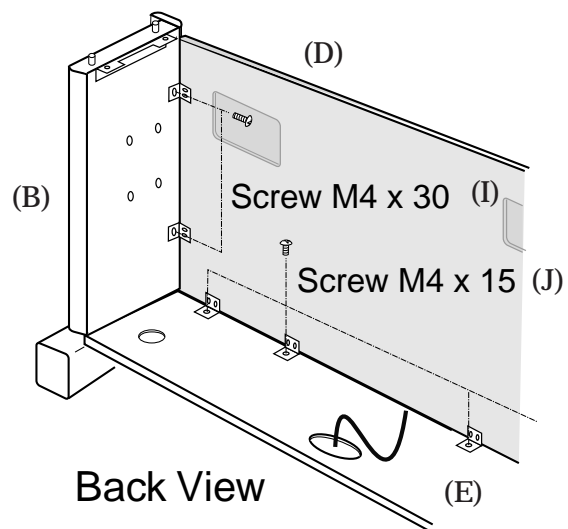



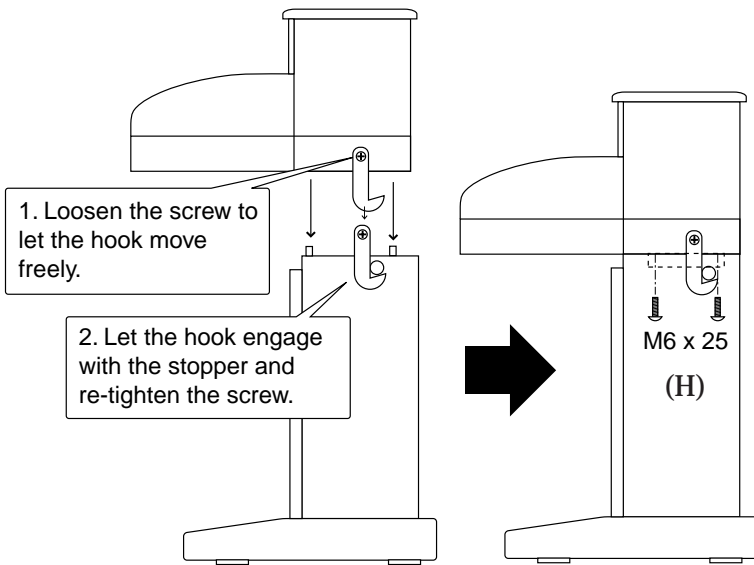

**6.** Loosen the screws of the hooks and carefully put the main unit on the stand. Align the dowels of the stand to the holes of the main unit.

**7.** Let the hooks engage with the stoppers and re-tighten the screws.

**8.** Fasten the main unit and the stand with four screws (H).

**CAUTION:**

Be sure to secure the main unit to the stand with the screws. If you fail to do so, the unit could fall from the stand causing damage or personal injury.

**9.** Put the right speaker box (the one with two connectors) on the speaker support and align the screw holes to the holes of the right Side Panel (B). Fix with four screws (G).

**10.** Repeat the same for the left speaker box.

**11.** Take the speaker support out after attaching the speaker boxes.

**12.** Connect the both speaker cables together and then connect to the speaker cable connector of the main unit.

**13.** Put the pedal cable to the pedal cable connector of the main unit.

**14.** Attach the speaker cables and pedal cable with vinyl binders as illustrated.

**15.** Connect the power cable to the power cable connector of the main unit. Put it through the hole of the pedal board and fix with Cord Clamp and screw (L) at the pedal board near the hole. Turn the cord around the Cord Clamp as illustrated.

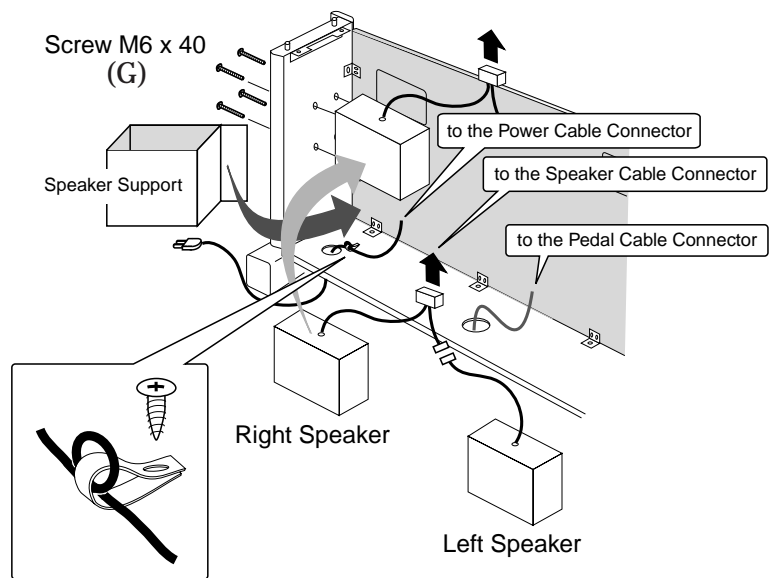

**Bottom View (Main Unit)**

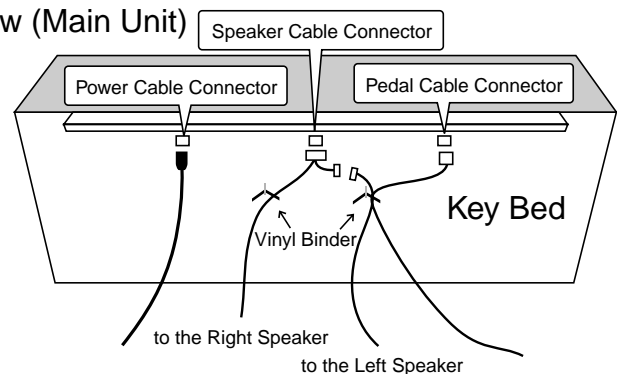

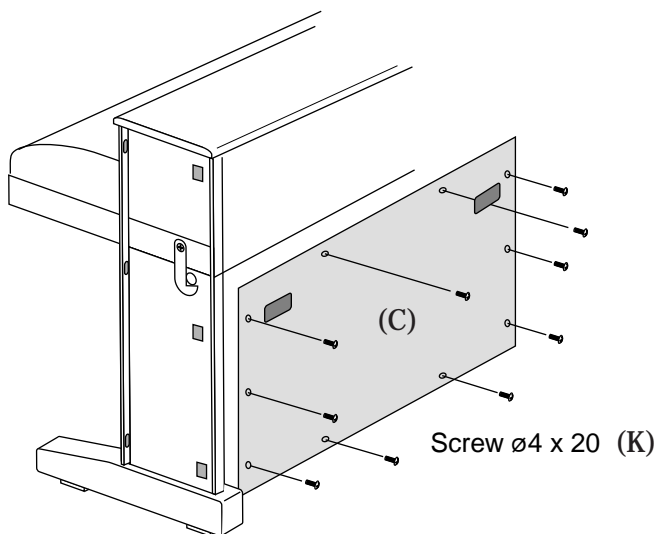

**16.** Place the Back Board (C) behind the stand and attach with ten screws (K).

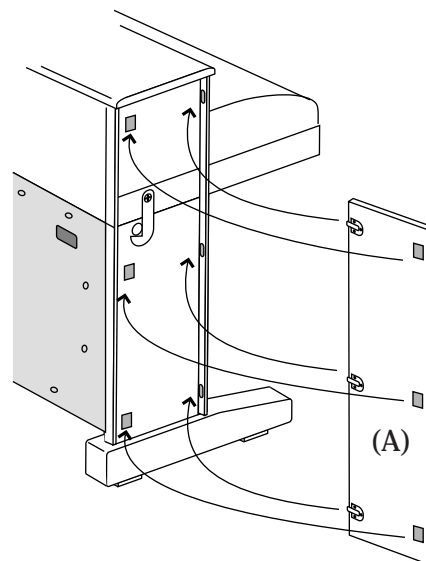

**17.** Put the hooks of the End Panel (A) to the holes of the side of the piano and attach with velcro tapes. Push firmly. There is no difference between right and left panels.

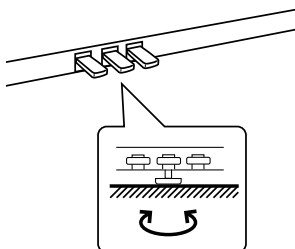

**18.** Turn the adjuster (installed on the bottom of the Pedal Unit) down until it makes firm contact with the floor. If the floor is carpeted, place a spiked furniture cup under the adjuster so that it makes firm contact with the carpet backing. Press any pedal with your foot. If the pedal rail flexes, lower the adjuster until flexing is minimized.

**CAUTION:**

Before moving your piano, turn the adjuster up so that it clears the floor.

## ASSEMBLING THE MUSIC RACK

**1.** Place the music rack a little right side of the center of the piano. Push the music rack forward slightly.

**2.** Slide the music rack to the left and it will be locked at the center of the piano.

\* When disassembling the music rack, bring it slightly up and slide it to the right.

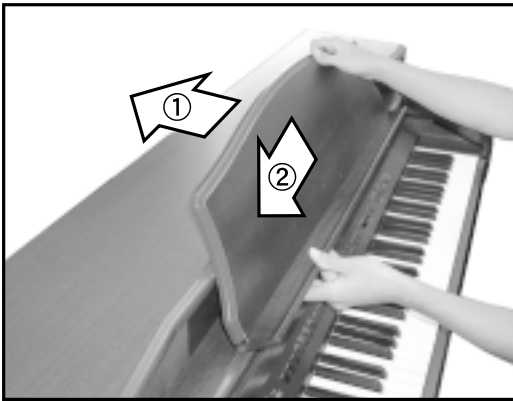

# CA1200, CA1000 Digital Piano Tutorial Section

---

## Basic Operations

---

p. 10

This section explains step by step the setup and operation procedures needed to begin playing your CA piano.

<i>SETTING UP THE PIANO</i> . . . . .	10
<i>PLAYING THE PIANO</i> . . . . .	10
<i>PLAYING WITH MORE SOUNDS</i> . . . . .	11
<i>ADDING THE EFFECTS</i> . . . . .	14
<i>USING THE METRONOME</i> . . . . .	15
<i>NEXT STEP TO MAKE</i> . . . . .	17

---

## Using the Recorder

---

p. 18

This section will show you how to use the Recorder.

Recording and playing back a song, recording multiple songs, and recording on two separate tracks.

<i>RECORDING A SONG</i> . . . . .	18
<i>PLAYING BACK A SONG</i> . . . . .	18
<i>BASICS OF THE RECORDER</i> . . . . .	19
<i>RECORDING MORE THAN ONE SONG</i> . . . . .	20
<i>RECORDING THE TRACKS SEPARATELY</i> . . . . .	21
<i>ERASING UNNECESSARY SONG DATA</i> . . . . .	23

---

## Using MIDI

---

p. 25

This is an introduction for the beginner to the world of MIDI.

You will learn the basics of MIDI and MIDI applications using the CA piano and another MIDI device.

<i>UNDERSTANDING MIDI</i> . . . . .	25
<i>USING THE CA PIANO AS CONTROLLER</i> . . . . .	27
<i>USING THE CA PIANO AS A MULTI-TIMBRAL SOUND MODULE</i> . . . . .	31

With Kawai's unique feature "Concert Magic" anyone can sit at the CA piano and play real music.

<i>SELECTING A SONG</i> . . . . .	34
<i>LISTENING TO THE SONG</i> . . . . .	35
<i>PERFORMING A SONG</i> . . . . .	35
<i>CONCERT MAGIC SONG ARRANGEMENT TYPES</i> . . . . .	36
<i>STEADY BEAT</i> . . . . .	38



# 1. BASIC OPERATIONS

## SETTING UP THE PIANO

The first thing you'll need to do before playing the piano is to set up the instrument.

### ASSEMBLING THE STAND

First, you need to assemble the stand unit. Assemble the stand following the instructions at the beginning of this manual.

### SUPPLYING AC POWER

The CA piano is equipped with stereo speakers and an amplifier. You do not need any other equipment to play your piano. You can enjoy the CA piano wherever AC power is available. Simply connect the power cable that comes with the CA piano to an AC outlet.

**Connect the AC power cable to the piano's power jack and the other end of the cable to the AC outlet on the wall.**

### USING THE HEADPHONES

For private performances you may want to use the headphones. The speakers will be turned off automatically when the headphones are plugged in, and the CA piano will only be heard through the headphones. The CA piano has two headphones jacks.

## PLAYING THE PIANO



### Turning on the power.

You will find the POWER SWITCH at the right end of the front panel. Press this button to turn on the power. Pressing it again will turn off the power.

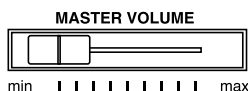

### Adjust the volume level.

The VOLUME SLIDER controls the volume level of the speakers and the headphones. Use this slider to set the volume to a comfortable listening level.

### Now try playing the keyboard.

You will hear the CA's main piano sound. The name of the sound "Concert Grand" is shown in the LCD Display.

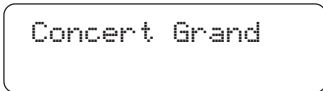

The CA piano responds just like a real acoustic piano when you play it. It produces a louder sound when you play hard and a softer sound when you play soft. The volume level changes in relation to how fast the keys are pressed. This system is called “**touch sensitivity**” on an electronic musical instrument. The initial touch sensitivity setting has been adjusted to the standard of an acoustic piano. You can however, select a different type of touch sensitivity on the CA piano if you are not comfortable with the standard setting. For more detail, please read “**3. Touch**” on page 67.

## USING THE PEDALS

The CA piano has three pedals—just like a grand piano. They are Sustain, Soft and Sostenuto.

The sustain pedal is capable of responding to half pedaling, which provides even finer control of the dampening effect.

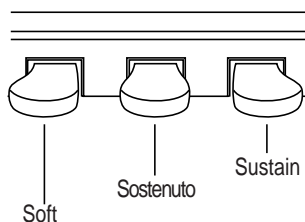

## PLAYING WITH MORE SOUNDS

You have already heard the CA's main piano sound. The CA1200 has a total of forty sounds (thirty for the CA1000), not only different types of piano sounds but different instruments as well.

The different instrument sounds built into CA piano are called “**preset sounds**”.

All of the preset sounds have been created through advanced digital sampling technology achieving as natural and realistic sound as possible. Let's try some of the preset sounds.

## SELECTING ANOTHER PRESET SOUND

Press the **SOUND SELECT** button under the name of the instrument you would like to listen to. When the button is pressed, the LED indicator will be turned on to indicate that this sound is selected.



The name of the selected preset sound is also shown in the LCD Display.



The SOUND SELECT buttons are assigned with three (CA1000) or four (CA1200) preset sounds to select. **To select the other sounds, press the button repeatedly.**

You can also select any preset sounds by using the VALUE buttons.

## USING DEMO FUNCTION

The CA piano has 27 built-in demo songs. Each of the demo songs presents a musical piece to introduce the different preset sounds.



**Press the DEMO button** and the demo song for the Classic Grand category will start. After the Classic Grand demo songs are finished playing, the demo songs for another sound category will be selected at random.

If you would like to listen to the demos for a particular category, just press the desired SOUND SELECT button while the demo is playing. When you press the button, the demo will play the demo songs for the newly selected category. Then the demo songs for another category will be selected at random. See page 80 for the list of demo songs.

## DUAL

Another feature of the CA piano is the ability to layer two preset sounds together to create a more complex sound. For example, piano layered with strings, electric piano with choir sound, and so on.

**To layer two sounds, press the SOUND SELECT buttons for both sounds simultaneously.** The LED indicators for each will be turned on to indicate the two sounds you have chosen. You will find the selected sound names are also shown in the LCD display.

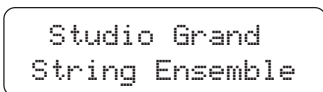

*Both sound names are displayed.*



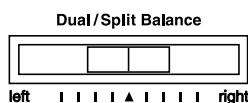

You can adjust the volume balance between the two sounds. **Use the DUAL/SPLIT BALANCE slider to adjust the balance.** Move the slider to the right to increase the volume of the rightmost preset sound and decrease the volume of the leftmost preset sound. The balance changes in the opposite way when the slider is moved to the left.

## SPLIT

The CA piano provides you with another type of sound combination called a **split**. The split function divides the keyboard into two sections—**upper keyboard** and **lower keyboard**—and lets you play a different sound in each section.



**Press the SPLIT button to activate the split function. Press the SOUND SELECT button for the sound you would like to use for the upper keyboard. Then, while holding down the SPLIT button, press another SOUND SELECT button to select a sound for the lower keyboard.** The LED indicator for the upper sound will be turned on and the LED for the lower sound will start flashing. The LCD display will show the names of the two selected sounds.

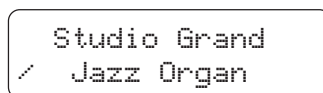

*Sound name for the upper keyboard*  
*Sound name for the lower keyboard*

You can adjust the volume balance between the two sounds. **Use the Dual/Split Balance slider to adjust the balance.** Move the slider to the right to increase the volume of the upper sound and decrease the volume of the lower sound. The balance changes in the opposite way when the slider is moved to the left.

The split point determines where the upper keyboard section will be divided from the lower one. You can move the split point to any key you like. To do this, please read “**8. Split Button**” in the Reference section, page 56.

## ABOUT POLYPHONY

The CA piano is capable of playing up to 64 notes simultaneously (64-note polyphony). When playing in dual mode, or when playing the stereo piano sound, the polyphony will be reduced by half since the piano has to produce two sounds for each note.

## ADDING THE EFFECTS

You might have noticed that when you select some of the preset sounds, the LED indicator for the EFFECTS is turned on. The reason for this is some of the preset sounds are set up with an effect on as their initial setting.

Adding an effect to the sound enhances tonal quality and improves acoustical realism. The CA piano is provided with two separate groups of effects. The first is reverb and the second contains chorus, delay, tremolo and rotary speaker.

### **REVERB**

Reverb adds reverberation to the sound, simulating the acoustic environment of a recital room, stage, or concert hall. There are five types of reverb available. They are Room, Stage, Hall, 3D Room and 3D Hall (listed in order of reverberation amount).

### **CHORUS**

Chorus is an effect that simulates the rich character of a vocal choir or string ensemble, by layering a slightly detuned version of the sound over the original to enrich it.

### **DELAY**

Delay is an effect that adds echoes to the sound. There are three types of delay available (delay 1 - 3), each of which has a different length of delay between the echoes.

### **TREMOLO**

This is a vibrato type effect.

### **ROTARY**

This effect simulates the sound of the Rotary Speaker cabinet commonly used with electronic organs. Rotary 1 is normal rotary and Rotary 2 is with distortion effect.

The soft pedal is used to change the speed of the rotor between SLOW and FAST.



## TO ADD REVERB

**Press the REVERB button.** The LED indicator will be turned on to indicate that reverb is in use. Press and hold the REVERB button and the currently selected reverb type will be shown in the LCD display.



Reverb Type  
= Room

*The reverb type is displayed.*

**To change the reverb type, use the VALUE buttons.**

## TO ADD OTHER EFFECTS



**Press the EFFECTS button.** The LED indicator will be turned on to indicate that the effect is in use. Press and hold the EFFECTS button and the currently selected effect will be shown in the LCD display.

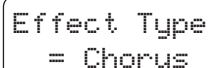

Effect Type  
= Chorus

*The selected effect is displayed.*

**To change the effect type, use the VALUE buttons.**

**To turn off the reverb or effects, press the REVERB or EFFECTS button again.**

### ◆ NOTE

Any changes you make to the reverb and the effects are stored with the preset sound in memory as long as the power is on. When you reselect a sound, your chosen reverb and effect settings will be recalled along with the preset sound.

When the power is turned off the effects will be reset to the factory settings unless you use the “User Memory” function to save your current reverb and effect settings.

For more information about the “User Memory” function please see page 50 in the reference section of this manual.

## USING THE METRONOME

Rhythm is one of the most important elements when learning music. It is important to practice playing the piano at the correct tempo and with a steady rhythm. The CA piano’s metronome is a tool that helps you to achieve this by providing a steady beat for you play along with.

## STARTING THE METRONOME

**Press the TEMPO button.** You will see the LED indicator turn on and hear the metronome begin counting with a steady beat. The LCD display shows the tempo in beats per minute.

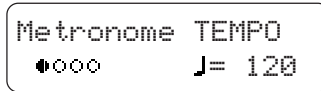
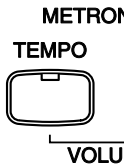

*Tempo is displayed in number of beats per minute.*

**To change the tempo, use the VALUE buttons to increase or decrease the tempo within the range of 20 - 300 beats per minute. (40-600 BPM with eighth note rhythms).**

**To stop the metronome, press the TEMPO button again.**

## CHANGING THE TIME SIGNATURE

You probably noticed that there are two types of clicks and the louder one comes every fourth beat. The metronome is capable of giving you a down beat to indicate the beginning of the measure. You are now hearing a 4-beat or 4/4 time signature. The LCD also displays the beats per measure visually

You can select a different time signature, if you want to, out of the nine available with the CA piano—1/4, 2/4, 3/4, 4/4, 5/4, 6/8, 7/8, 9/8 and 12/8.



To change the time signature, use the BEAT button.

**Press the BEAT button.** You will see the LED indicator turn on and hear the metronome begin counting. The LCD display shows the time signature and a visual indicator of beats per measure.

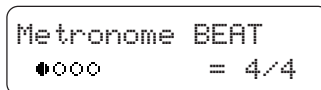

*The selected time signature is displayed along with a visual indicator of beats per measure.*

**Use the VALUE buttons to select your desired time signature.** You will see the time signature currently selected in the LCD display. The visual indicator will change to match the selected time signature.

**To stop the metronome, press the BEAT button again.**

You can use either the TEMPO or BEAT button to turn the metronome on and off. Choose the appropriate button depending on whether you're adjusting the tempo or changing the time signature.

## ADJUSTING THE METRONOME VOLUME

The volume level of metronome can be adjusted to any level you like independent of the main volume.

**Press the TEMPO and BEAT buttons simultaneously.** The LCD displays the volume level of the metronome in numbers from 1 (soft) to 10 (loud). The factory preset is 5.

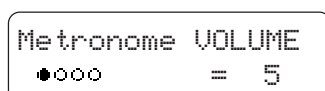

*The volume level is displayed.*

**Use the VALUE buttons to change value.**

### ◆ NOTE

All the metronome settings will be reset to the factory preset values after turning off the power unless you use the “User Memory” function to save your current metronome settings.

For more information about the “User Memory” function please see page 50 in the reference section of the manual.

## NEXT STEP TO MAKE

So far, you have learned the basic operations and terms needed to become familiar with the CA piano. There are, however, some other functions that will help you to make full use of the CA piano’s many capabilities. You may continue on from here, or skip ahead to the chapters you are interested in.

If you would like to learn more about the recorder, go to chapter 2. “**Using the Recorder**” page 18.

If you are interested in MIDI and how to use your piano with other digital musical instruments, go to chapter 3. “**Using MIDI**” page 25.

If you would like to learn about Concert Magic, go to chapter 4. “**Concert Magic**” page 34.

If you would like to learn more about functions and features such as tuning and transpose for example, you will find detailed information in chapter 4. “**Menu Buttons**” of the Reference Section, page 46.

## 2. USING THE RECORDER

The CA piano's recorder records your playing much like a tape recorder, and it is just as easy to use. The CA piano records a song as digital data instead of audio data and stores the song inside the instrument. Because the song is stored as digital information you can modify the song when you play it back. You can, for example, adjust the tempo without changing the pitch or use a different effect setting from one you have recorded. Once you understand the recorder, you will find it to be a useful tool for both practicing and playing the piano.

### RECORDING A SONG

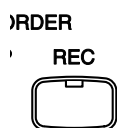

**Press the REC button when you are ready to record.** The LED indicator will start flashing telling you that the piano is ready to record.

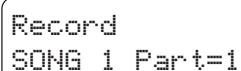

```
Record
SONG 1 Part=1
```

*The LCD display shows the song number and part number that will be recorded.*

**Now play some music on the piano.** The recorder will automatically start recording with the first note you play.



**Press the PLAY/STOP button when you're finished recording.** The CA piano will stop recording and the LCD display will momentarily display a message "Stopping" while the song is saved to memory.

If you make a mistake, you can record your piece again. Just repeat the same procedure. The second recording will completely erase the first one.

### PLAYING BACK A SONG

The CA Piano will be ready to play back the song as soon as you're finished recording.

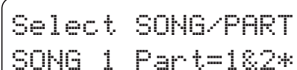

```
Select SONG/PART
SONG 1 Part=1&2*
```

*The LCD Display shows you the number of the song you just recorded.*

**Press the PLAY/STOP button to play back the song.**  
**Press the PLAY/STOP button again to stop play back and return to the song-select display.**

**To exit from the recorder, press any SOUND SELECT button.**

Now, you are familiar with the basic recording procedure on the CA piano. For most recording purposes this may be all you need. The CA piano however, is equipped with other more powerful and flexible features that can be used to record and play back your performances. Continue on to learn more about the full capabilities of the recorder.

## **BASICS OF THE RECORDER**

Let's take a brief look at the recorder's features.

### **TWO-TRACK FIVE-SONG RECORDER**

The CA piano's recorder is a **2-track 5-song recorder**. This means you can record up to five different songs, store them in memory, and play them back as you like.

Each song has two separate tracks called "**Parts**" that can be recorded separately. This lets you record for example, the left hand part first on one track, then record the right hand part next on the other track while listening to the first track.

When you record or play back a song, you can select which part (track) of which song you are going to record or play back. When you are recording, selecting the same part again to record will erase any previous recordings on that part. Because of this it's important to remember; when recording both parts separately, after recording the first part be sure to select the second part to record, otherwise you will end up recording over the first part of the song.

### **RECORDED INFORMATION**

The CA piano records the following:

**Note information**

**Sound selection**

**Pedal movements**

**Dual settings . . .** Set the dual balance as desired before you start recording. Balance settings made before you start recording will be used by the recorder. Any changes made during the recording will be ignored by the recorder.

**Transpose. . . . .** When you record in a different key using the transpose function, the CA piano will record the actual transposed notes you hear, not the notes as you play with the keyboard.

**RECORDING CAPACITY**

The total recording capacity is about 8,000 notes. Pressing any buttons or pedals is counted as one note.

When the recorder reaches it's maximum capacity, the CA piano will stop recording at that point.

**RECORDER AND METRONOME**

When playing back a song with the metronome turned on, the metronome always restarts with the down beat.

**RECORDING MORE THAN ONE SONG**

The CA piano is capable of recording up to five different songs. Let's try recording a second song.

If you followed the procedure in the previous section you have already recorded Song 1, so now let's record Song 2.

**Press the REC button to enter the song/part selection menu.  
Use the MENU buttons to change the song number to Song 2.**

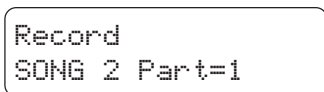

*The LCD display shows the song number and part number to be recorded.*

**When you are ready to record, just start playing the keyboard.**  
The CA piano will start recording automatically with the first note you play.  
**When you are finished recording, press the PLAY/STOP button.**

Now let's play back the song that you have just recorded.  
**Press the PLAY/STOP button again to play back the song.**

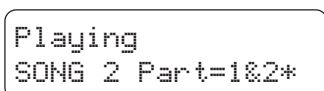

*The LCD display shows the song number you have just recorded.*



**Press the PLAY/STOP button again to stop.**

**If you would like to listen to a different song, use the MENU buttons to select your desired song number.**

◆ **NOTE**

You have probably noticed that there is an asterisk (\*) after the part number in the LCD display. This indicates that the selected song has been recorded. You can tell which songs have been recorded by looking for the asterisk.

## RECORDING THE TRACKS SEPARATELY

Now let's record two tracks separately.

First, you select the desired track (part) to record. After recording the first part, select the other track and record your second part.

**Press the REC button to enter the song/part selection menu.**

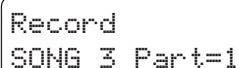

Record  
SONG 3 Part=1

*The LCD display shows the song number and part number to record.*

**Use the MENU buttons to select song 3.**

**Record the first part just the same as in the previous sections and press the PLAY/STOP button when you're finished recording.**

**Now press the REC button to enter the song/part menu then select Part 2 to record.**

**Use the VALUE buttons to select part 2.**



Record  
SONG 3 Part=2

*The LCD display shows the song and part number to be recorded.*

If you want to start recording the second part from the beginning of the song, **just play the keyboard**. You will hear the first part playing back while you record the second part.

If you would like to play back the first part and then start recording the second part from a certain point later in the song, press the PLAY/STOP button instead of playing the keyboard to start playback of the first part and then begin recording the second part from any point you like.

**When you are finished recording, press the PLAY/STOP button again.**

## PLAYING BACK THE PARTS SEPARATELY

**While you are in the play back menu, use the VALUE buttons to select the desired part number you want to listen to.**

The image shows a rectangular LCD display with a black border. Inside, the text is arranged in two lines: the top line says "Playing" and the bottom line says "SONG 3 Part=2\*".

*An asterisk indicates that the part has been recorded.*

You can select between, “Part 1”, “Part 2”, and “Part 1&2”. To check that you have recorded on both tracks, select “Part 1”, then select “Part 2”. You will see an asterisk after each part, this means you have successfully recorded both parts.

**To listen to both parts together select “Part 1&2”.**

**To play back an individual part, select the desired part using the VALUE button first, then press the PLAY/STOP button to listen.**

### ◆ NOTE

If you don’t see an asterisk after each part you recorded or if your song does not play back correctly, carefully reread the previous section to make sure you’re recording properly. You can use the LCD display to help determine if you have a problem.

**Here are some basic things to check for:**

- 1) If you only hear the second part, you may have accidentally recorded over the first part. In this case, just re record the first part you played after selecting the “empty” part to record (in this case it will probably be part 2).
- 2) Did you record one of the parts in a different song? In this case record the missing part in the appropriate song.

## ERASING UNNECESSARY SONG DATA

At some point you may want to erase a song. If you have filled up the memory of the recorder you can erase an old song to make room for a new one or maybe you're tired of listening to a particular song. In either case, the CA piano provides an easy way to erase one or all of the songs and parts.

**To erase a specific song or part, first press both the REC and PLAY/STOP button.** The LCD display will display the erase menu where you select a song or a part to erase.

```
To Del Press REC  
SONG 1 Part=1&2*
```

*Select the song and the part to erase.*

**Use the MENU buttons to select the desired song, and use the VALUE buttons to select the desired part to erase.**

**Press the REC button to erase.** The LCD display will ask you if you're sure.

```
Sure? Press REC  
SONG 1 Part=1&2*
```

*Confirmation to erase the song.*

**If you are sure you want to erase the song and part, press the REC button one more time.**

```
Delete Completed  
SONG 1 Part=1&2
```

*The erase procedure is completed.*

**If you want to cancel the erase procedure, press the PLAY/STOP button.**

**Press any of the SOUND SELECT buttons to exit from the song erase menu.**

## ERASING ALL DATA

**To erase everything, all songs and parts at once, first turn the power off and then turn it back on again while holding down both the REC and PLAY/STOP button.** The entire memory of the recorder will be erased.

The CA piano's built-in recorder is easy to use and is perfect for practice and basic recording needs. For those individuals interested in using this instrument for more complex digital recordings, the CA piano can be connected to an external MIDI sequencer or a personal computer. Please read chapter 3. **Using MIDI** to learn about the CA piano's MIDI and Multi-timbral capabilities.



## 3. USING MIDI

---

In this chapter you will learn how you can create music by connecting the CA piano to an external MIDI device.

The CA piano is compatible with MIDI devices from Kawai and other manufacturers. It can also be used with sequencing software on a personal computer.

### UNDERSTANDING MIDI

#### WHAT IS MIDI?

The letters MIDI stand for Musical Instrument Digital Interface, an international standard for connecting MIDI equipped synthesizers, drum machines, and other electronic instruments so that they can exchange data. Personal computers can also be equipped for MIDI communication. Electronic instruments equipped with MIDI can transmit and receive performance data such as, notes, what sound to play, pedal information, volume, etc. This data can be recorded with a device like a sequencer or a computer.

#### MIDI JACKS

Instruments equipped with MIDI usually have three jacks for exchanging data: **IN**, **OUT**, and **THRU**. (Some instruments have only IN and OUT.) These jacks are used to connect MIDI devices to one another using a special cable.

Each terminal has a different function.

**IN** : For receiving MIDI data from another MIDI instrument.

**OUT** : For sending MIDI data to another MIDI instrument.

**THRU** : For passing along MIDI data received to another MIDI instrument without processing.

Depending on how they are connected, instruments are grouped as those which receive data (producing sound when data is received from a connected instrument), those which send data (to instruments to which they are connected), and those which both send and receive data.

## MIDI CHANNEL

MIDI uses what are known as “**channels**” as a means of routing MIDI data intended to play a specified instrument or specified part. By channelizing MIDI data, you can control multiple parts in multiple instruments with a single cable.

There are two aspects of channels, one for receiving and one for sending. The MIDI channel of the receiving instrument must be matched with the MIDI channel of the transmitting instrument. The idea is just like television or radio. If you have a desired station to watch or listen to, you need to tune in to the right channel. When a transmitting instrument uses channel 1, the receiving instrument must be set to use channel 1 also. The CA piano lets you set the same channel number for both Transmit and receive. There are 16 MIDI channels available to choose from on the CA piano. In addition to channel-to-channel connection, it is possible to receive multiple channels. With MIDI instruments equipped with **multi-timbral capabilities**, you can receive multiple parts on multiple channels each played with a different sound simultaneously. For example, a MIDI instrument might receive the melody on channel 1, the chords on 2, the bass on 3, and assign a different instrument to each channel. Piano for channel 1, strings for 2, electric bass for 3. In this way, the CA piano can play up to 16 different parts each with a different sound.

Here’s a diagram (next page) to summarize the MIDI connections we have discussed.

Instrument #1, which is transmitting the piano part on channel 1 (Ch 1), the string part on Ch 2 and the bass part on Ch 3, is connected to Instrument #2. Instrument #3 is connected to MIDI Thru on instrument #2. The receive channel is set to 1 for Instrument #2 and multi-timbral mode is turned off. On instrument #3 multi-timbral mode is on.

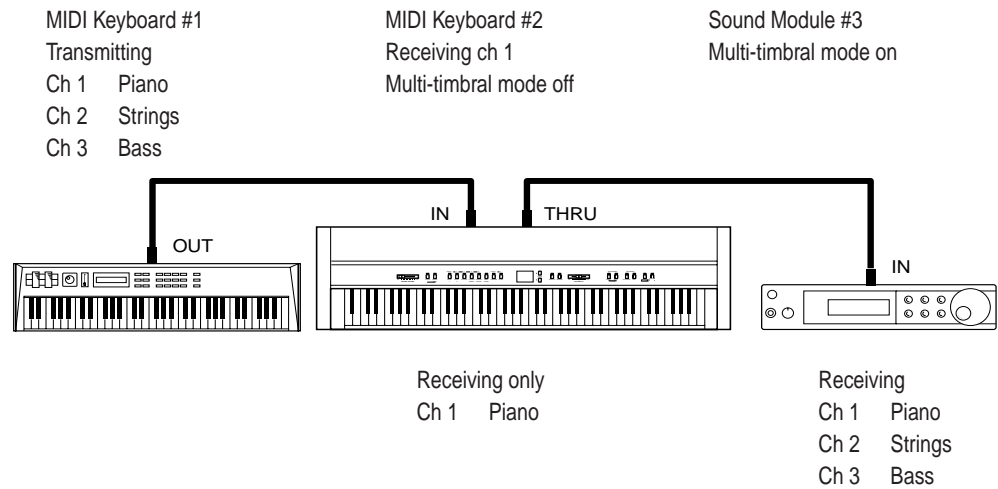

Instrument #2 recognizes only the piano part received from Instrument #1. Instrument #3 receives all the parts on the three channels being passed through Instrument #2 because Instrument #3's multi-timbral mode capability is activated.

We have provided this brief look at MIDI to help you understand the CA piano's MIDI capabilities.

While it is beyond the scope of this manual to explain the entire world of MIDI we do encourage you to visit your local music store or contact a music publisher for a listing of available books on MIDI applications to learn more.

Let's explore some MIDI applications using an external MIDI device connected to the CA piano.

## USING THE CA PIANO AS CONTROLLER

First let's play sounds from an external MIDI device using the CA piano's keyboard.

### MIDI CONNECTION

First, connect the CA piano's MIDI OUT jack to your external MIDI device's MIDI IN jack with a MIDI cable.

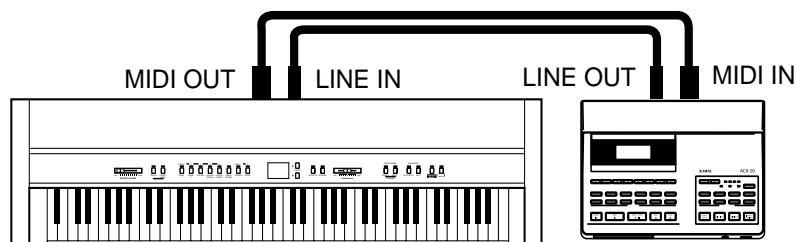

Next you must match the MIDI channel. The transmitting channel of the CA piano and receiving channel of your external MIDI device must be the same.

### CHANGING TRANSMITTING CHANNEL

**To change the transmit channel on the CA piano, press the MENU button several times until you see “5. MIDI Channel”.**

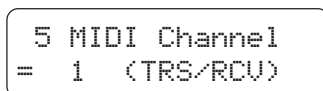

*The LCD display will indicate the channel number that is currently selected.*

**Change the channel by using the VALUE buttons.** You can select from 1 to 16.

**Press any SOUND SELECT button to exit from the function menu.**

### AUDIO CONNECTION

If your external MIDI device is not equipped with an amplifier or speakers, you can connect it directly to the CA piano using the LINE IN jacks or to an external sound system.

**Connect the LINE IN jacks of the CA piano and the LINE OUT (audio output) jacks of your external MIDI device with a pair of audio cables (see the illustration above).** Now you will be able to hear the CA piano’s sound and your external MIDI device’s sound together through the CA’s speakers. Use the volume control on your external MIDI device to balance it’s volume with the CA piano.

Now You’re ready to play.

Play the CA piano’s keyboard. You should hear both instruments as you play. What is happening is that the CA piano is transmitting MIDI information, what note you played, how hard (loud) you played it, and so on to your external MIDI device. The external MIDI device reproduces sound based on this information using its own sound module.



### PROGRAM CHANGE

Press a SOUND SELECT button on the CA. You will hear the sound on your external MIDI device also changes. Pressing a SOUND SELECT button lets the CA piano transmit a “**program change**” number. A program change is the type of MIDI command that tells the receiving instrument what sound or instrument to play your notes with.

Actual program change information is just a number, from 1 to 128, not an instrument name. You select the desired instrument with a specific number. Not all MIDI instruments assign the same sound to the same program change number. MIDI instruments that conform to the General MIDI (GM) standard however “DO” assign the same sound to the same program change number. For example program change #1 will always be an acoustic piano sound on a “GM” compatible synth, and program change #33 will always be an acoustic bass sound. Because of this, when connecting two “GM” instruments together, selecting the right sound is not a problem. The CA piano is not a General MIDI instrument and its internal sounds do not conform to the General MIDI standard. This means when you select a sound on the CA piano such as Classic E. Piano you will probably hear a different sound playing from your external MIDI device. What sound you hear will depend on the sound assignments on your external MIDI device. Below is a chart of the Program Change number/sound assignment mapping for the first twelve CA piano sounds and the first twelve “GM” sounds. Please see page 75 in the reference section for more detail. The CA piano can have different mappings depending on the setting for multi-timbral mode (explained later in this chapter).

Program #	CA1200	CA1000	General MIDI
1	Concert Grand	Concert Grand	Grand Piano
2	Studio Grand	Studio Grand	Bright Piano
3	Mellow Grand	Mellow Grand	Electric Grand
4	Jazz Grand	Modern Piano	Honky Tonk Piano
5	Modern Piano	Rock Piano	Electric Piano 1
6	Rock Piano	New Age Piano	Electric Piano 2
7	New Age Piano	Classic E.Piano	Harpsichord
8	Honky Tonk	Modern E.P. 1	Clavi
9	Classic E.Piano	Modern E.P. 2	Celesta
10	Modern E.P. 1	Jazz Organ	Glockenspiel
11	Modern E.P. 2	Drawbar Organ 1	Music Box
12	Modern E.P. 3	Drawbar Organ 2	Vibraphone

In order for your external MIDI device to play the sound you want, you need to know what program change number to transmit to it. Please read your external MIDI device's manual for a list of its program change number/sound assignments. Then read "Sending Program Change Numbers" in the Reference section, page 48 for the procedure to send a desired program change number from the CA piano.

That is how to layer the CA piano's sound with a desired sound from an external MIDI device.

### LOCAL CONTROL

You may want to play and only hear your external MIDI device's sound, without the CA piano's sound. You can turn off the CA piano's sound using a function called "local control".

Local control determines whether or not the CA piano will produce a sound when you play its own keyboard. When local control is on, the CA piano produces sound as you play the keys. When off, the piano will not produce a sound when you play the keys. The CA piano's keyboard will however, continue to transmit MIDI information to an external MIDI device.

**Press the MENU buttons until you see "7. Local Control".**

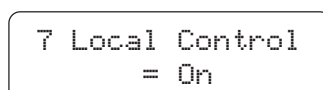

*The LCD display will read "on", which means the piano is currently set to local control on.*

**To turn it off, use the VALUE buttons.**

**Press any SOUND SELECT button to exit from the function menu.**

Play the keyboard and you will hear only the sound from your external MIDI device.

To change the sound from the CA piano, select the desired number as explained in the Reference section and send it from the CA piano to your external MIDI device.

It may be possible to change preset sounds directly on your external MIDI device. In this case you may want to set the CA piano so that it does not transmit program changes. Read "8. Transmit Program Change On/Off" in the reference section on page 49 to learn how to prevent the CA piano from transmitting program changes.

## USING THE CA PIANO AS A MULTI-TIMBRAL SOUND MODULE

The CA piano can also be used as a 16-part multi-timbral sound module. Your CA piano is capable of playing back for example, a four part song with two piano parts, a string part, and a choir part all sent from an external MIDI sequencer or a personal computer. You can also play the CA piano along with a recorded song.

To set the CA piano to receive MIDI as a multi-timbral instrument it must be connected with an external MIDI device or personal computer with appropriate software.

Connect the CA piano's MIDI IN jack and your external MIDI device's MIDI OUT jack with a MIDI cable. Please note that the MIDI information is now being transmitted the opposite of our earlier setup. The CA piano is now receiving MIDI data from your external MIDI device.

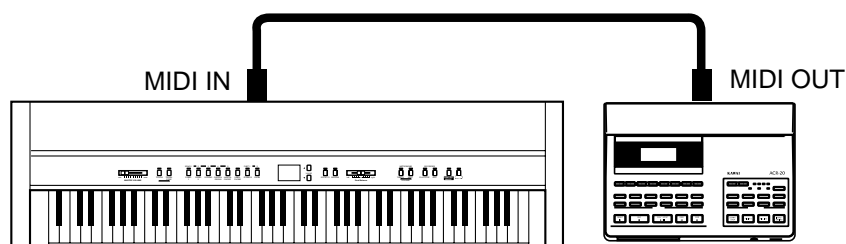

### MIDI CHANNEL

The next step is to match your MIDI channels. When receiving MIDI data on the CA piano with multi-timbral mode ON, it is not necessary to specify a MIDI channel to use because the CA piano can receive data on multiple MIDI channels at once. You do have to be careful to match MIDI channels between each part. A MIDI channel can only have one sound assigned to it at a time. You must set the MIDI channel for each part on both the transmitting (external MIDI device) and the receiving (CA piano) MIDI devices. For example, channel 1 for piano, ch 2 for strings, ch 3 for choir, etc.

## MULTI-TIMBRAL MODE

**Multi-timbral On** is a setup for 16-channel multi-timbral operation. You can mute the channels separately. Each channel recognizes the program change numbers as listed on page 75.

**Multi-timbral Off** turns off the multi-timbral capability. If you would like to have the CA piano receive MIDI data on a single channel and ignore all data on the other channels set multi-timbral to “Off”. Remember, if you want the CA piano to receive MIDI information from an external device, in this setup you must match the receiving channel with the transmitting channel. Program change numbers are recognized as listed on page 75.

To demonstrate the multi-timbral capability of the CA piano, let’s choose Multi-timbral On.

**Press the MENU buttons until you see “9. Multi Timbre”.**



9 Multi Timbre  
= Off

*The LCD display will read “OFF”, which means Multi-timbral Off is currently selected.*

**Use the VALUE buttons to select Multi-timbral On. The display will read “ON”.**

After choosing the multi-timbral setting, press any SOUND SELECT button to exit from the function menu.

Let’s see how this works using an external MIDI device. If you have a keyboard connected to the CA piano try playing some notes. You should hear the CA piano as you play. If you have a MIDI song player or personal computer with MIDI software connected try sending some MIDI song data with one or more different musical parts to the CA. Again you should hear the CA piano playing all the parts. In multi-timbral mode, if you want to hear a particular sound for each part you transmit to the CA you must send the correct Program/sound number from the transmitting MIDI device to the CA piano. Please see page 75 for a list of the Program/sound number assignments for the CA piano.

If you own a “GM” sound module you’ll probably want to use it as your multi-timbral module instead of the CA piano. If you have a hardware sequencer or personal computer but do not own another sound module, you can enjoy sixteen-part multi-timbral capability with only the CA piano.

MIDI may seem a little difficult to work with at first, but once mastered it offers many new and exciting ways to enjoy music.

While this manual avoids going into too much detail regarding the technical aspects of MIDI such as “system exclusive data”, for those who are more familiar with MIDI or want to be, this manual provides technical MIDI information and a MIDI Implementation Chart, on page 76 and 77.



## 4. PLAYING WITH CONCERT MAGIC

The great German composer Johann Sebastian Bach once said, “Playing the keyboard is simple. Just strike the right keys at the right time.”

Many people wish it were that simple. The reality is very different of course. However, there is a way to make playing the keyboard very simple. You don’t even have to strike the right keys thanks to Concert Magic.

With CONCERT MAGIC, absolutely anyone can sit at the CA piano and make real music... even if you’ve never taken a piano lesson in your life. To enjoy performing by yourself, you have only to select your favorite piece from 176 preprogrammed songs and tap any of the 88 piano keys with a steady rhythm and tempo. CONCERT MAGIC will provide the correct melody and accompaniment notes, regardless of which keys you press. Anybody, young or old, can enjoy CONCERT MAGIC from the moment they sit down at the CA piano.

Now let’s see how CONCERT MAGIC works.

### SELECTING A SONG

The 176 Concert Magic songs are assigned to each of the 88 piano keys, two songs for each key. There are two banks of songs, Bank A and Bank B. Each bank contains 88 songs.

The songs are also classified in eight groups by song category such as Children’s Songs, American Classics, Christmas Songs.

All of the song titles are listed on page 76 in the reference section of this manual. To make it easier to find which song is assigned to which key, there is a key strip that can be placed between the end of black keys and the front panel. The key strip indicates song categories, and note names.

CONCERT  
MAGIC



**To select a song, press the key to which your desired song is assigned while holding down the CONCERT MAGIC button.**

A01  
Twinkle Twinkle

*The LCD display shows you the song number and abbreviated song title.*

You have selected a song in Bank A. **To select a song in Bank B, press the same key again.** The LCD display shows you another song title with “B” at the beginning. Repeatedly pressing the key switches between the two banks.

## LISTENING TO THE SONG

If you have selected a song you are familiar with, you may want to play by yourself right away. However you may want to listen to the song first before playing it.



**To listen, press the PLAY/STOP button.** The CA piano will start playing back the selected song. You can adjust the speed or tempo of the song by using the VALUE buttons while holding down the TEMPO button. While you are listening you can select a different Concert Magic song by using the VALUE buttons.

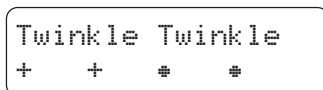

*The circles turn into small plus signs as the song is playing.*

You probably noticed that the circles in the LCD display turn into smaller plus signs as the song is played back. This is called the Note Navigator. These circles and plus signs provide a visual guide that shows you when to press the next key. The space between the circles and position of the circles in the LCD shows you the approximate timing between each key press.

The key to performing using Concert Magic is to know the rhythm of the song. The Note Navigator provides a rough outline of the songs rhythm, that will help you to learn the song's rhythm and then perform it by yourself.

**If you want to listen to a different song, press the key to which your desired song is assigned while holding down the CONCERT MAGIC button. To listen, press the PLAY/STOP button.**

When you are finished listening to the song, **press the PLAY/STOP button again to stop.**

## PERFORMING A SONG

Now you're ready to play yourself.

**Tap out the rhythm of the selected song on any one of the 88 black or white keys on the piano's keyboard.**

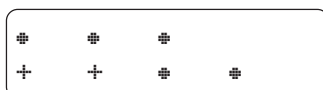

*Use the Note Navigator (the circles and plus signs) to learn the rhythm of the Concert Magic song.*





### MELODY PLAY

These songs are also quite easy to play, especially if they are familiar to you. To perform them, tap out the rhythm of the melody on any key on the keyboard. Singing along as you tap the rhythm can be helpful.

Play “Twinkle, Twinkle, Little Star” for example. Follow the melody’s rhythm as shown.

Key on    x x x x    x x x    x x x x x x x



When performing fast songs with Concert Magic, it is sometimes easier to tap two different keys with two fingers alternating. This allows you to play twice as fast as you can using only one finger on one key.

### SKILLFUL

These songs range in difficulty from moderately difficult to difficult. To perform them, tap out the rhythm of both the melody and the accompaniment notes on any key on the keyboard, like “Waltz of the Flowers” shown below. The Note Navigator will be very helpful with the Skillful songs.

Waltz of Flowers  
\* \* \* \* <

Key on    x x x x x    x x x x x x x



It may take some practice to get them just right. A good way to learn these songs is to listen to them first, and then try to tap out the rhythms that you hear.

#### ◆ NOTE

In the song list in the reference section on page 78, the arrangement type is marked next to each song title as “**EB**” for Easy Beat, “**MP**” for Melody Play and “**SK**” for Skillful.

## STEADY BEAT

Regardless of which arrangement type a Concert Magic song is, with Steady Beat you can play any Concert Magic song by simply tapping any key with a constant steady beat.

**Press and hold the CONCERT MAGIC button.** The LCD display will change to show the current Concert Magic mode in the second line.

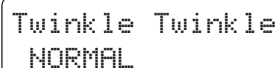

Twinkle Twinkle  
NORMAL

*The current mode is NORMAL.*

While still holding the CONCERT MAGIC button, **use the VALUE button to change the Concert Magic mode to STEADY BEAT.**



Twinkle Twinkle  
STEADY BEAT

*The mode is changed to STEADY BEAT.*

**Start by tapping any key with a constant steady beat.** Your tapping will set the tempo for the song. Both the accompaniment and melody parts will be played automatically in time with the tempo you tap.

# CA1200, CA1000 Digital Piano

## Reference Section

---

### Operation of the Panel Components

---

p. 40

This section describes the operation of the panel components—buttons, sliders, and jacks. If you are familiar with playing a digital piano, reading this section first may help you understand the CA piano faster. In this section you can look into the particular functions for detailed information and operation instead of reading through the manual from the beginning.

1. <i>CONCERT MAGIC BUTTON</i> . . . . .	40
2. <i>DEMO BUTTON</i> . . . . .	43
3. <i>SOUND SELECT BUTTONS</i> . . . . .	45
4. <i>MENU BUTTONS</i> . . . . .	46
5. <i>VALUE BUTTONS</i> . . . . .	52
6. <i>EFFECT BUTTONS</i> . . . . .	53
<i>SELECTING AN EFFECT (EFFECTS BUTTON)</i> . . . . .	53
<i>REVERB (REVERB BUTTON)</i> . . . . .	54
7. <i>DUAL / SPLIT BALANCE SLIDER</i> . . . . .	55
8. <i>SPLIT BUTTON</i> . . . . .	56
9. <i>METRONOME BUTTONS</i> . . . . .	57
<i>CHANGING TEMPO (TEMPO BUTTON)</i> . . . . .	57
<i>CHANGING THE TIME SIGNATURE (BEAT BUTTON)</i> . . . . .	58
<i>CHANGING THE METRONOME VOLUME (TEMPO &amp; BEAT BUTTONS)</i> . . . . .	58
10. <i>RECORDER BUTTONS</i> . . . . .	59
<i>RECORDING (REC BUTTON)</i> . . . . .	59
<i>PLAYING BACK A SONG (PLAY/STOP BUTTON)</i> . . . . .	62
11. <i>TRANSCOPE BUTTON</i> . . . . .	64
12. <i>VIRTUAL TECHNICIAN BUTTON</i> . . . . .	65
13. <i>POWER SWITCH</i> . . . . .	72
14. <i>VOLUME SLIDER</i> . . . . .	72
15. <i>PEDALS</i> . . . . .	73
16. <i>JACKS</i> . . . . .	74
<i>CONCERT MAGIC SONG LIST</i> . . . . .	78
<i>FRONT PANEL, SPECIFICATIONS</i> . . . . .	80

---

### MIDI Information

---

p. 75

This section provides technical information on MIDI—exclusive data structure and tables such as Program Change Number Assignment and Implementation.



# 1. CONCERT MAGIC BUTTON

---

CONCERT  
MAGIC



Thanks to CONCERT MAGIC, absolutely anyone can sit at the CA piano and make real music... even if you've never taken a piano lesson in your life. To enjoy performing by yourself, you have only to select your favorite piece from 176 preprogrammed songs and tap any key with a steady rhythm and tempo. CONCERT MAGIC will provide the correct melody and accompaniment notes, regardless of which keys you press.

## SELECTING A CONCERT MAGIC SONG

176 Concert Magic songs are assigned to each of the 88 piano keys, two songs for each key. There are two banks of songs, Bank A and Bank B. Each bank contains 88 songs. The songs are classified in eight groups by song category such as Children's Songs, American Classics, Christmas Songs.

All the song titles are listed on page 78 in this section. To make it easier to find which song is assigned to which key, there is also a key strip that indicates song categories, and note names.

**To select a song, press the key to which your desired song is assigned while holding down the CONCERT MAGIC button.**

A01  
Twinkle Twinkle

*The LCD display shows the song number and the abbreviated name.*

**To select a song in Bank B, press the same key again. Repeatedly pressing the key switches between the two banks.**

Concert Magic songs can also be selected with the VALUE buttons. **Press the Concert Magic button, then use the VALUE buttons to select a song.**

## LISTENING TO THE SELECTED SONG

To listen to a Concert Magic song, first follow the song selection procedure then press the **PLAY/STOP** button.

Adjust the speed or tempo of the song by using the **VALUE** buttons while holding down the **TEMPO** button.

The LCD display will only display the tempo value while the **Tempo** button is pressed.

To stop play back of the song press the **PLAY/STOP** button again.

To restart the currently selected song from the beginning, press play again.

You can select a different Concert Magic song during playback with the **VALUE** buttons.

## **LISTENING TO ALL THE CONCERT MAGIC SONGS**

Press the **CONCERT MAGIC** button and then press the **PLAY/STOP** button without selecting a song. The CA piano will play back all the preset songs in order.

## PERFORMING THE SELECTED SONG

After following the song selection procedure, tap out the rhythm of the selected song on any one of the 88 black or white keys on your piano keyboard.

As you tap harder, the notes will get louder; as you tap softer, the notes will get quieter. As you tap faster, the notes speed up; as you tap slower, they will slow down correspondingly.

To help you learn the Concert Magic song's rhythm, the LCD Display gives you a visual guide (•, +). This is the Note Navigator. The Note Navigator provides a rough outline of the songs rhythm, that will help you to learn the song's rhythm and then perform it by yourself.

Twinkle Twinkle
+   +   •   •

*The Note Navigator (the circles and plus signs) indicates the rhythm of each note.*

The circles turn into small plus signs as soon as each note is played.

When performing fast songs on Concert Magic, it is sometimes easier to tap two different keys with two fingers alternating. This allows you to play twice as fast as you can using only one finger on one key.

**Adjust the relative volume of the melody notes and accompaniment notes with the DUAL BALANCE slider.**

## **CONCERT MAGIC SONG ARRANGEMENT TYPES**

Each of the 176 Concert Magic songs is arranged in one of three arrangement types.

### **EASY BEAT**

These are the easiest songs to play. To perform them, simply tap out a constant steady beat on any key on your piano keyboard.

### **MELODY PLAY**

These songs are also quite easy to play, especially if they are familiar to you. To perform them, tap out the rhythm of the melody on any one of the keys on your piano keyboard. Singing along as you tap the rhythm can be helpful.

### **SKILLFUL**

These songs range in difficulty from moderately difficult to difficult. To perform them, tap out the rhythm of both the melody and the accompaniment notes on any of the keys on your piano keyboard.

It may require some practice to successfully play these selections. Even skilled players will enjoy the challenge of the skillful pieces. Try listening to these songs first, and then try to tap out the rhythms that you hear.

### **STEADY BEAT**

With Steady Beat you can play any Concert Magic song by just tapping any key with a steady beat regardless of which arrangement type the song is.

First you need to change the Concert Magic mode from NORMAL to STEADY BEAT. Press and hold the CONCERT MAGIC button. Use the VALUE button to change the mode.

(See page 38 for details.)

## 2. DEMO BUTTON

---



The CA piano has twenty seven demo songs built in. Each demo song presents a brief musical piece to introduce the different preset instruments.

The 176 Concert Magic songs can be demonstrated as well.

### PRESET SOUND DEMO

To listen to all the demo songs, simply press the DEMO button. The CA piano will begin the demo. The demo songs for the sounds in the Classic Grand category will begin the demo.

All of the Classic Grand demo songs will be played back in order. Then another category will be selected at random and the demo songs for that category will be played. New sound categories will be selected at random until the DEMO button is pressed again to stop.

To select the demos for a particular sound button, press the desired SOUND SELECT button while the demo is playing. The demo songs for that category will play and then another sound category will be selected at random.

### CONCERT MAGIC SONG DEMO

There are two ways to listen to the Concert Magic songs in the DEMO mode.

**1. Press the piano key to which the desired song is assigned while holding down the DEMO button.**

The CA piano will play back the selected song and, then play the rest of songs in the same song category one after another.

**2. Press the CONCERT MAGIC button and then press the DEMO button.**

The CA piano will play back all of the Concert Magic songs in random order.

To stop the demo, press the DEMO button again.

To select the songs in different categories, select a song from the desired category.



# 3. SOUND SELECT BUTTONS

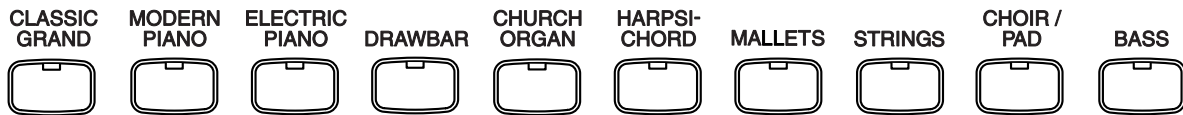

## SELECTING A SOUND

These buttons are used to select the desired instrument to play. Press the appropriate button and the LED indicator will be turned on to indicate that it is selected.



The Sound Select buttons have three or four sounds assigned to them. Repeatedly pressing these Sound Select buttons switches among those sounds.

Piano sounds available on the CA Piano

- CLASSIC GRAND    Concert Grand
- Studio Grand
- Mellow Grand
- Jazz Grand (CA1200 only)
- MODERN PIANO    Modern Piano
- Rock Piano
- New Age Piano
- Honky Tonk (CA1200 only)
- ELECTRIC PIANO    Classic E.Piano
- Modern E.P. 1
- Modern E.P. 2
- Modern E.P. 3 (CA1200 only)

## DUAL

You can layer any two preset sounds (Dual).

**Press any two Sound Select buttons simultaneously to activate the DUAL mode.**

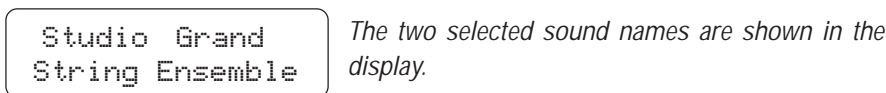



If you want to layer two sounds assigned to the same SOUND SELECT button, while pressing the desired Sound Select button use the VALUE buttons to select your desired layered sound.

## **SELECTING A DEMO SONG**

When listening to the demo songs, the Sound Select buttons are used to select the different demo songs.

**Use one of the ten Sound Select buttons to select a desired preset sound category to demonstrate after pressing the DEMO button.**

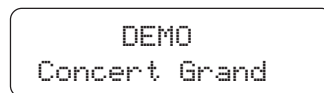

*Name of the selected sound is displayed*



## 4. MENU BUTTONS

---

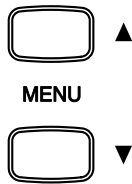

These buttons are used to access the various functions that control the CA piano's tuning, system and MIDI functions. They are:

1. Brilliance
2. Lower Octave Shift
3. Lower Pedal On/Off
4. Tuning
5. MIDI Channel
6. Transmit Program Change Number
7. Local Control On/Off
8. Transmit Program Change Number On/Off
9. Multi-Timbral Mode On/Off
10. Channel Mute (MIDI Ch. On/Off)
11. User Memory
12. Factory Reset

### COMMON OPERATION

To select a function that you want to adjust, press either of the MENU buttons. The LCD will display "1 Brilliance", the first item in the menu.

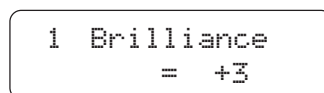

Press the MENU buttons again to select a different function to edit.

Use the VALUE buttons to change value.

To exit the function menu, press any SOUND SELECT button.

#### ◆ NOTE

Once the power is turned off, all settings will be reset to the factory preset values unless you use the "User Memory" function to save your current settings.

For more information about the "User Memory" function please see page 50 in this section of the manual.

## 1. BRILLIANCE

Brilliance lets you adjust brightness of the preset sounds.

After selecting the “Brilliance” function by pressing the MENU buttons, use the VALUE buttons to change the value to the desired amount.

```
1 Brilliance
  = +3
```

*The LCD display shows the brilliance setting with a number. “0” indicates the standard setting.*

Brilliance can be set between -5 to +5. Plus settings produce a brighter tone, minus settings produce a mellower tone.

Brilliance settings are global for all the preset sounds. You can not have an individual setting for each sound.

## 2. LOWER OCTAVE SHIFT

This allows the octave of the lower part to be shifted up one, two, or three octaves higher when you use the split function.

After selecting the “Lower Octave Shift” function by pressing the MENU buttons, use the VALUE buttons to select your desired shift range.

```
2 LowerOctShift
  = 1
```

*The LCD display shows the lower part is shifted one octave up.*

Lower Octave Shift can be set between 0 to 3.

## 3. LOWER PEDAL ON/OFF

This determines if the sustain pedal will be active for lower sound when in SPLIT mode. The default setting is Off which means the sustain pedal is not active the lower sound.

After selecting the “Lower Pedal” function by pressing the MENU buttons, use the VALUE buttons to turn it on and off.

```
3 Lower Pedal
  = On
```

*The LCD display shows whether Lower Pedal is on or off.*

## 4. TUNING

Tuning allows you to adjust the piano's pitch. You may need to adjust the tuning when you play with other instruments.

**After selecting the "Tuning" function by pressing the MENU buttons, use the VALUE buttons to adjust the tuning.**

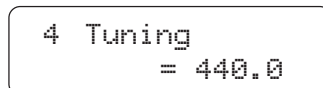

4 Tuning  
= 440.0

*The LCD display shows the current pitch setting.*

**The LCD display shows the pitch for "A" in Hz (Hertz). The range of adjustment is from 427.0 to 453.0 Hz. The factory preset value is set to the modern standard A = 440.0 Hz.**

## 5. MIDI CHANNEL

This determines on which MIDI channel the CA piano will exchange MIDI information with an external MIDI instrument or a personal computer.

**After selecting the "MIDI Channel" function by pressing the MENU buttons, use the VALUE buttons to select your desired number.**

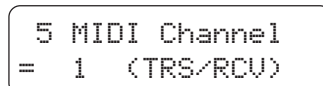

5 MIDI Channel  
= 1 (TRS/RCV)

*The LCD display shows the currently selected channel number.*

## 6. SENDING PROGRAM CHANGE NUMBERS

This function allows the CA piano to transmit program change numbers beyond the 40 (CA1200) or 30 (CA1000) pre-defined numbers transmitted by the sound select buttons. Using this function, you can send any number from 1 to 128.

**After selecting the "Send PGM #" function by pressing the MENU buttons, use the VALUE buttons to select your desired number.**

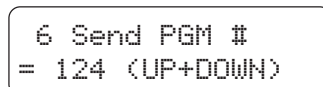

6 Send PGM #  
= 124 (UP+DOWN)

*The LCD display shows the program change number.*

**To send the program change number, press both VALUE buttons simultaneously.**

## 7. LOCAL CONTROL ON/OFF

This determines whether the CA piano's sound will be played from the piano's keyboard ("ON") or only from an external MIDI instrument ("OFF").

Even with local control "off" the piano's keyboard will still transmit to an external MIDI instrument or personal computer.

**After selecting the "Local Control" function by pressing the MENU buttons, use the VALUE buttons to turn on and off.**

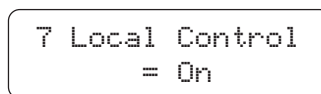

7 Local Control  
= On

*The LCD display shows whether Local Control is on or off.*

## 8. TRANSMIT PROGRAM CHANGE ON/OFF

This determines whether or not the CA piano will transmit program change information when pressing the SOUND SELECT buttons. When this is turned on, pressing the SOUND SELECT buttons will send the program change numbers as listed in page 75.

**After selecting the "Transmit PGM" function by pressing the MENU buttons, use the VALUE buttons to turn it on and off.**

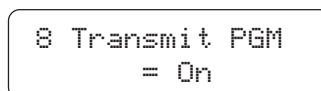

8 Transmit PGM  
= On

*The LCD display shows whether or not program change numbers will be transmitted.*

## 9. MULTI-TIMBRAL MODE

Multi-timbral mode allows the CA piano to receive data on more than one MIDI channel simultaneously. In this mode, the CA piano can play different musical parts with different sounds for each part.

### **Multi-Timbral On**

This is a flexible 16 part multi-timbral setup. You can turn individual MIDI channels on and off, and assign any program number to any channel in the way you like.

### **Multi-Timbral Off**

This turns off the multi-timbral capability. Only one MIDI channel will be active and only the preset sound currently selected will be heard when a MIDI signal is received.

After selecting the “Multi-Timbre” function by pressing the MENU buttons, use the VALUE buttons to turn it on and off.

9 Multi Timbre  
= On

The LCD display shows the selected Multi-timbral mode.

## 10. CHANNEL MUTE

This determines which MIDI channels are activated to receive MIDI information when the Multi-Timbral is set to on. You can activate or deactivate each of the 16 channels individually.

Select the “Channel Mute” function by pressing the MENU buttons. Keep pressing the MENU buttons to select each of the sixteen channels

10 Channel Mute  
Channel 1= Play

The LCD display shows the selected MIDI channel number.

Use the VALUE buttons to switch between PLAY and MUTE.

10 Channel Mute  
Channel 1= Mute

Select “Play” to turn the channel on or “Mute to turn it off.

### ◆ NOTE

When the Multi-timbral mode is set to off the “Channel Mute” function will not be displayed in the function menu.

## 11. USER MEMORY

This function allows the CA piano to save the user-definable settings when the power is turned off. Once written to the memory, the saved settings will be recalled every time you turn the power on.

The following settings can be saved—Effect settings, Metronome settings (tempo, time signature and volume), starting sound, primary sound for each sound category, all 10 menu functions, and all of the Virtual Technician functions.

Select the “User Memory” function by pressing the MENU buttons.

```
11 User Memory  
Save →Press REC
```

Press the REC button to memorize your desired settings.

```
11 User Memory  
Save completed
```

The LCD display briefly shows the above message and the current settings are saved.

◆ **NOTE**

The “User Memory” function does not automatically save any changes made to the settings every time the power is turned off. You must use the User Memory function each time you want to save your current settings.

## 12. FACTORY RESET

This function resets the CA piano to the factory settings. All parameters you saved in “User Memory” will be reset to the factory preset values.

Select the “Factory Reset” function by pressing the MENU buttons.

```
12 Factory Reset  
Reset→Press REC
```

Press the REC button to reset the CA piano.

◆ **NOTE**

This function will not be displayed in the function menu until you save your settings in User Memory.

SONG data in RECORDER, User Touch and User Temperament will not be reset by this function.

## 5. VALUE BUTTONS

---

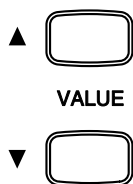

### CHANGING VALUE

These two buttons are used to change the value for certain functions.

First select the function or option you would like to change the value for by pressing the appropriate button(s), then use the VALUE buttons to change the value. “ ▲ ” button increases the value and “ ▼ ” decreases the value.

### CHANGING SOUNDS

These buttons can also be used to select the various sounds. You can select all of the preset sounds assigned to the ten SOUND SELECT buttons.

However, Sounds cannot be selected by using the Value buttons when you are in DUAL or SPLIT mode.





## 6. EFFECT BUTTONS

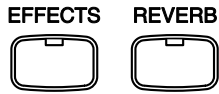

### SELECTING AN EFFECT (EFFECTS BUTTON)

Use the EFFECTS button to add an effect to the sound. There are seven digital effects; CHORUS, DELAY1-3, Rotary Speaker1-2, and a Tremolo effect that can be used to enhance the sound of the preset tone.

#### CHORUS

Chorus is an effect that simulates the rich character of a vocal choir or string ensemble, by layering a slightly detuned version of the sound over the original to enrich it.

#### DELAY

Delay is an effect that adds echoes to the sound. There are three types of delay available (delay 1-3), each of which has a different length of delay between the echoes.

#### TREMOLO

This is a vibrato type effect.

#### ROTARY SPEAKER

This effect simulates the sound of the Rotary Speaker cabinet commonly used with electronic organs. Rotary 1 is normal rotary and Rotary 2 is with distortion effect.

The soft pedal is used to change the speed of the rotor between SLOW and FAST.

To add an effect to the sound, press the EFFECTS button. The LED indicator will be turned on to indicate that the effect is in use. Press and hold the EFFECTS button and the currently selected effect will be shown in the LCD display. To change the effect type, use the VALUE buttons.

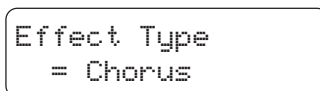

The LCD Display shows the currently selected effect.

To turn off the effects, press the EFFECTS button again.

## REVERB (REVERB BUTTON)

Use the REVERB button to add reverberation to the sound. There are five types of reverb built-in: ROOM, STAGE, HALL, 3D ROOM, and 3D HALL.

To add reverb to the sound, press the REVERB button. The LED indicator will be turned on to indicate that the reverb is in use. Press and hold the REVERB button and the currently selected reverb type will be shown in the LCD display. To change the reverb type, use the VALUE buttons.



Reverb Type  
= Room

*The LCD Display shows the currently selected type of reverb.*

To turn off the reverb press the REVERB button again.

### ◆ NOTE

The effect and reverb settings are stored with the sound. When you select the same preset sound again your chosen effect will be recalled, until the instrument is turned off. Once the power is turned off, the effect will be reset to the factory setting unless you use the “User Memory” function to save your current reverb and effect settings.

For more information about the “User Memory” function please see page 50 in this section of the manual.



## 7. DUAL / SPLIT BALANCE SLIDER

---

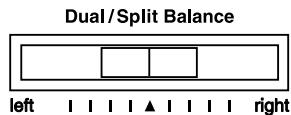

### DUAL BALANCE

When playing in dual or split mode, this slider controls the volume balance of the two sounds.

**Move the slider to the right to increase the volume of the rightmost preset sound of the pair and decrease the volume of the leftmost preset sound. The balance changes in the opposite way when the slider is moved to the left.**

### SPLIT BALANCE

You can adjust the volume balance between the two sounds.

**Use the DUAL/SPLIT BALANCE slider to adjust the balance. Move the slider to the right to increase the volume of the upper sound and decrease the volume of the lower sound. The balance changes in the opposite way when the slider is moved to the left.**

### PART VOLUME BALANCE FOR CONCERT MAGIC

When used with Concert Magic, the slider adjusts the volume balance of the melody part and the accompaniment.

**As the slider is moved to the right, the sound of the melody becomes louder and the accompaniment becomes softer. The balance changes in the opposite way when the slider is moved to the left.**

## 8. SPLIT BUTTON

---



### SELECTING SPLIT SOUNDS

The split function divides the keyboard into two sections—upper and lower—and lets you play each part with a different sound.

First press the desired **SOUND SELECT** button to select the upper sound. Then, while holding down the **SPLIT** button, press the desired **SOUND SELECT** button to select the lower sound. The **LED Indicator** for a lower sound will start flashing.

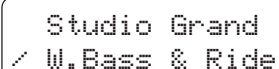
A rectangular LCD display showing two lines of text. The first line reads "Studio Grand" and the second line reads "/ W.Bass & Ride".

```
Studio Grand
/ W.Bass & Ride
```

*The LCD Display shows you which sounds are selected for the upper and lower sections.*

To adjust the volume balance of the two sounds, use the **DUAL/SPLIT BALANCE** slider.

### CHANGING THE SPLIT POINT

The default split point is set between B2 and C3. This point can be moved to anywhere on the keyboard.

Press the desired key while holding down the **SPLIT** button.

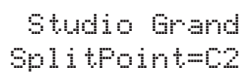
A rectangular LCD display showing two lines of text. The first line reads "Studio Grand" and the second line reads "SplitPoint=C2".

```
Studio Grand
SplitPoint=C2
```

*The LCD Display will look like this when changing the split point.*

The key you pressed becomes the lowermost note for the upper section.

## 9. METRONOME BUTTONS

---

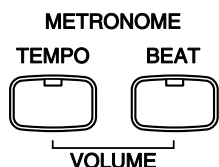

### CHANGING TEMPO (TEMPO BUTTON)

The TEMPO button is used to activate the metronome and adjust the tempo.

Press the TEMPO button. You will see the LED indicator turn on and hear the metronome begin counting with a steady beat. The LCD display shows the tempo in beats per minute.

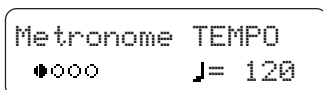

To change the tempo, use the VALUE buttons to increase or decrease the tempo within the range of 20 - 300 beats per minute. (40-600 BPM with eighth note rhythms).

Press the TEMPO button again to stop the metronome.

### ADJUSTING THE PLAYBACK SPEED FOR THE CONCERT MAGIC SONGS

The TEMPO button is also used to adjust the playback speed for the Concert Magic songs.

After selecting a Concert Magic song to play back, hold down the TEMPO button. The LED display will show the tempo value. While holding down the TEMPO button, use the VALUE buttons to change the tempo.

You can adjust the tempo, either before playing back a song or while the song is playing back.

## CHANGING THE TIME SIGNATURE (BEAT BUTTON)

The BEAT button is used to activate the metronome and select your desired time signature. The CA piano has nine settings to choose from: 1/4, 2/4, 3/4, 4/4, 5/4, 6/8, 7/8, 9/8 and 12/8.

**To change the time signature, press the BEAT button.**

You will see the LED indicator turn on and hear the metronome begin counting.

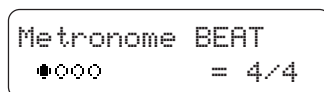

*The LCD display shows the currently selected time signature.*

**Use the VALUE buttons to select the desired time signature.**

**Press the BEAT button again to stop the metronome.**

## CHANGING THE METRONOME VOLUME (TEMPO & BEAT BUTTONS)

The volume of the metronome can be adjusted to any level you like.

**Press the TEMPO and BEAT buttons simultaneously.** The LED displays the volume level of the metronome in numbers from 1 (soft) to 10 (loud). The factory preset is 5.

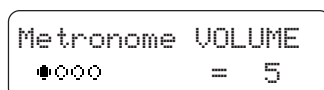

*The LCD display shows the current volume level.*

**To change the volume level, use the VALUE buttons while holding down the TEMPO and BEAT buttons.**

**Press the both buttons simultaneously again to stop the metronome**

### ◆ NOTE

All the metronome settings will be reset to the factory preset values after turning off the power unless you use the "User Memory" function to save your current metronome settings.

For more information about the "User Memory" function please see page 50 in this section of the manual.



# 10. RECORDER BUTTONS

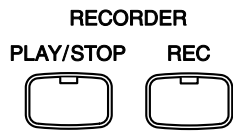

## RECORDING (REC BUTTON)

The REC button is used for recording.

Press the REC button to enable the CA piano to record. The LED indicator above the button starts flashing to tell you that the piano is ready to record.

```
Record  
SONG 1 Part=1
```

*The LCD Display shows the Song and Part number to be recorded.*

Begin playing some music on the keyboard. The CA piano automatically begins recording on the first note you play.

Press the PLAY/STOP button when you are finished recording. The piano will stop recording and save your song to memory.

Saving to memory may take a few moments and during this time the piano will not perform any other operations.

You can start recording by pressing the PLAY/STOP button instead of pressing a key. In this way, you can insert a blank bar at the beginning of the song.

## RECORDING ANOTHER SONG

The CA piano can record and store up to five songs.

Press the REC button to enable the CA piano to record. The LCD Display shows you which song is ready to record.

```
Record  
SONG 2 Part=1
```

*The LCD Display shows the Song number.*

Use the MENU buttons to select the desired song number to record. Then start recording by following the regular recording procedure.

Press the PLAY/STOP button when you are finished recording.

## RECORDING A SECOND PART

You can record a second part in the second track (part) of the same song.

Press the REC button to enable the CA piano to record. The LCD Display shows you which part number is ready to record.

A rectangular box representing an LCD display. The text inside is arranged in two lines: the first line says "Record" and the second line says "SONG 1 Part=1\*".

*The LCD Display shows the part number.*

Use the VALUE buttons to switch between Part 1 and Part 2. Then start recording by following the regular recording procedure.

Press the PLAY/STOP button when you are finished recording.

## STATUS OF SONG AND PART

In the LCD display an asterisk (\*) after the part number means that the part has been already recorded.

A rectangular box representing an LCD display. The text inside is arranged in two lines: the first line says "Record" and the second line says "SONG 3 Part=2\*".

*"\*" indicates that this part has already been recorded.*



## RECORDING THE SECOND PART WHILE LISTENING TO THE FIRST PART

While recording the second part, you can listen to the first part.

Select the desired song, set the previously recorded track to play back and enable the empty track to record.

If you want to start recording the new part from the beginning of the song, just play the keyboard. You will hear the first part playing back while you record the new part.

If you would like to play back the first part and then start recording the second part from a certain point later in the song, instead of playing the keyboard press the PLAY/STOP button to start playback of the first part and then begin recording the second part from any point you like.

### ◆ NOTE

Recording a new part will completely erase data recorded previously in the same part in the same song.

## RECORDED INFORMATION

The CA piano records the following:

**Note information**

**Sound selection**

**Pedal movements**

**Dual settings**      Set the desired DUAL balance before you start recording.

(For more information see page 19 in the Tutorial section).

If you record in a transposed key, the song will be played back in the same key you heard when recording, not in the key that you played with the keyboard.

## MEMORY CAPACITY

The total memory capacity of the recorder is approximately 8,000 notes. When the memory becomes full, the recorder will automatically stop at that moment. The data recorded before the interruption will be retained. All song data will be saved even after turning off the power.

## PLAYING BACK A SONG (PLAY/STOP BUTTON)

The PLAY/STOP button is used to select a song and part to play, and to start and stop play back of the recorded songs.

**Press the PLAY/STOP button one time to select a specific song and part you would like to play back. Use the MENU buttons to select a song and use the VALUE buttons to select a part.**

```
Select Song/Part  
SONG 1 Part=1&2*
```

*The LCD Display shows that both parts of song 1 are selected to play back*

**Press the PLAY/STOP button again and the recorded song will start playing.**

```
Playing  
SONG 1 Part=1&2*
```

*The LCD Display shows that the selected song is playing.*

**Press the PLAY/STOP button again to stop play back and return to the song select display.**

## **USING THE PLAY/STOP BUTTON TO START RECORDING**

The PLAY/STOP button can also be used to start recording. In this way, you can insert a blank bar at the beginning of the song.

**Press the REC button to enable the piano to record first, then press the PLAY/STOP button. On pressing the PLAY/STOP button, the CA piano starts recording regardless of whether you press a key or not.**

## ERASING A SONG

This function allows you to erase any song you do not want to listen to.

**To erase a specific song or part, first press both the REC and PLAY/STOP button. The LCD display will display the erase menu where you select a song or a part to erase.**

```
To Del Press REC  
SONG 1 Part=1&2*
```

Use the **MENU** buttons to select the desired song, and use the **VALUE** buttons to select the desired part to erase.

Press the **REC** button to erase. The LCD display will ask you if you're sure.

```
Sure? Press REC  
SONG 1 Part=1&2*
```

If you are sure you want to erase the song and part, press the **REC** button again.

If you want to cancel the erase procedure, press the **PLAY/STOP** button.

```
Delete Completed  
SONG 1 Part=1&2
```

The erase procedure is completed.

## ERASING ALL THE SONGS

To erase all the songs at once, first turn off the power then turn it back on again while holding down both the **REC** and **PLAY/STOP** buttons.



# 11. TRANSPOSE BUTTON

TRANS-  
POSE



The transpose function lets you raise or lower the piano's key in half steps. This is especially useful when you have learned a song in one key and have to play it in another key. The transpose feature allows you to play the song in the original key, but hear it in another key.

**Press and hold the TRANSPOSE button.**

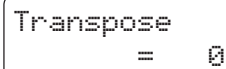

Transpose  
= 0

*The LCD display shows you the current value.  
The value is always set to "0" when the power is turned on.*

**While still holding the TRANSPOSE button, Use the VALUE buttons or the keyboard from C2 to C4 to specify the transposition amount.**

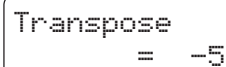

Transpose  
= -5

*The LCD display shows you a number telling you how many half steps up or down you have transposed the piano. -5, for example, represents a transposition that is 5 half steps lower. "0" indicates no transposition.*

The piano can be transposed up to 12 half steps higher or 12 half steps lower.

**Pressing both VALUE buttons at same time sets the value to "0".**

**Pressing TRANSPOSE button again turns the TRANSPOSE function off.**

The TRANSPOSE function remembers the current setting as long as the power is on.



## 12. VIRTUAL TECHNICIAN BUTTON

VIRTUAL  
TECHNICIAN



A piano technician is essential to an acoustic piano. He not only tunes the piano but also performs regulation and voicing adjustments to make the piano sound and play better. Virtual Technician simulates the work of a piano technician electronically and allows you to customize the CA piano to your personal taste. These are the functions of Virtual Technician.

1. Voicing
2. Sympathetic Resonance
3. Touch
4. Temperament
5. Key of Temperament

### COMMON OPERATION

To select a function that you want to adjust, press **VIRTUAL TECHNICIAN** button. The LCD will display “1 Voicing”, the first item in the menu.

```
1 Voicing
   = Normal
```

Press either of the **MENU** buttons to select a different function to edit.

Use the **VALUE** buttons to change value.

To exit the **VIRTUAL TECHNICIAN** menu, press any **SOUND SELECT** button.

#### ◆ NOTE

After you have customized the CA piano using the **VIRTUAL TECHNICIAN** functions you can use the “User Memory” function to save your settings. This way all of your current **VIRTUAL TECHNICIAN** settings will remain after the power is turned off.

For more information about the “User Memory” function please see page 50 in this section of the manual.

## 1. VOICING

Voicing is a technique used by piano technicians to mold the character of a piano's sound. The Voicing function lets you change the CA piano's tone quality by choosing one of four types of voicings.

- Bright** Produces a brighter tone throughout the entire dynamic range.
- Dynamic** The tone will change dramatically from mellow to bright with your playing.
- Mellow** Produces a mellower tone throughout the entire dynamic range.
- Normal** Produces the normal timbre of an acoustic piano throughout the entire dynamic range. This is the preset value.

After selecting the “Voicing” function by pressing the MENU buttons, use the VALUE buttons to select a desired voicing type.

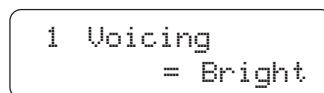

*The LCD display shows the type of voicing currently selected.*

The current voicing selection is global for all the preset tones. You can not have an individual setting for each tone.

### ◆ NOTE

While voicing is a technique used for optimizing the tone of an acoustic piano, this function can be used on all the sounds on the CA piano.

## 2. SYMPATHETIC RESONANCE

When the sustain pedal is depressed on an acoustic piano, all the dampers are lifted up allowing the strings to vibrate freely. When you play a note or chord on the piano with the sustain pedal depressed not only will the strings for the notes you played vibrate but other strings will vibrate in sympathetic resonance. The Sympathetic Resonance function simulates this phenomenon. You can select from three levels of resonance.

- Off** no resonance.
- Normal** simulates the natural resonance characteristics of an acoustic piano.
- Deep** Produces a more intense resonance.

After selecting the “Sympathetic Resonance” function by pressing the MENU buttons, use the VALUE buttons to select the desired setting.

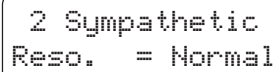

2 Sympathetic  
Reso. = Normal

*The LCD display shows the setting.*

## 3. TOUCH

Touch lets you select a different touch sensitivity for the keyboard from the standard touch of an acoustic piano. You can change the sensitivity to one of five different settings: LIGHT, LIGHT+, HEAVY, HEAVY+, OFF and User 1/2.

- Light** For those still developing finger strength. A louder volume is produced even when playing with a soft touch.
- Light+** For players with a delicate touch. Requires less striking force to achieve a forte note.
- Heavy** Perfect for those with strong fingers. Requires a heavier touch to produce a loud volume.
- Heavy+** Requires more striking force to achieve a loud volume.
- Off** A constant volume is produced regardless of how hard the keys are struck. This setting is suitable for sounds that have a fixed dynamic range such as Organ and Harpsichord.
- User 1/2** You can create your own custom touch curve to fit your playing style. Two user touch curves can be saved.

**After selecting the “Touch” function by pressing the MENU buttons, use the VALUE buttons to select your desired touch type.**

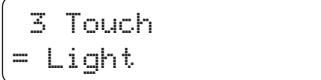

3 Touch  
= Light

*The LCD display shows the touch type currently selected. Normal is the default setting.*

Touch selection is global for all the preset tones. You can not have an individual setting for each tone.

### ◆ NOTE

LIGHT and HEAVY do not represent the physical weight of the keys. These are settings that affect the sensitivity of the keys, which determines the volume level in response to the key movement.

## USER TOUCH

After selecting the “Touch” function by pressing the MENU buttons, use the VALUE buttons to select User 1 or User 2.

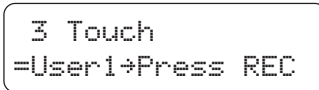

3 Touch  
=User1→Press REC

Press the REC button.

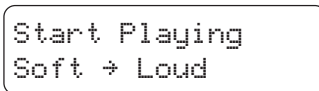

Start Playing  
Soft → Loud

Now start playing the CA piano dynamically from soft to loud in order to let the CA piano analyze your playing style.

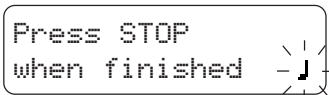

Press STOP  
when finished

While you are playing, a musical note will blink in the right corner of the LCD display.

Press the STOP button when you finish playing.

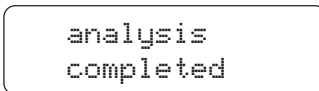

analysis  
completed

The CA piano will analyze your playing and create a custom touch curve for you based upon your playing style.

### ◆ NOTE

The user touch curve data is saved automatically even after the power is turned off. However, You must re select the user touch curve each time the power is turned on unless you save it as your default touch curve by using the User Memory function. Please see page 50 in this section for more information on User Memory.



## 4. TEMPERAMENT

The CA piano offers not only equal temperament (the modern standard) but also immediate access to temperaments popular during the Renaissance and Baroque periods. It should be interesting and educational to try some of the different temperaments, although the equal temperament is dominant today.

**After Selecting the “Temperament” function by pressing the MENU buttons, use the VALUE buttons to select your desired temperament.**

```
4 Temperament
= Equal(P.only)
```

*The LCD display shows the type of temperament currently selected.*

### BRIEF EXPLANATION OF TEMPERAMENTS

#### EQUAL TEMPERAMENT (PIANO ONLY)

```
4 Temperament
= Equal(P.only)
```

This is the default temperament. If a piano sound is selected the tuning is stretched like an acoustic piano (EQUAL TEMPERAMENT). If any other type of sound is selected the tuning will be EQUAL (FLAT). An explanation of EQUAL TEMPERAMENT and EQUAL TEMPERAMENT (FLAT) is provided later in this section.

#### ◆ NOTE

If a piano sound is used in a layer with any other sound then both sounds will use the EQUAL TEMPERAMENT (Stretched) tuning.

#### MERSENNE PURE TEMPERAMENT (MAJOR)

#### MERSENNE PURE TEMPERAMENT (MINOR)

```
4 Temperament
= Pure(Major)
```

This temperament, which eliminates dissonance's for thirds and fifths is still popular for choral music because of its perfect harmony.

```
4 Temperament
= Pure(minor)
```

You need to be aware what key you are playing in with this temperament. Any key modulation will result in dissonance's. When you play music in a particular key, you need to match the key of the temperament as well. When playing in a major key select Pure (Major) and when playing in a minor key select Pure (minor).

#### PYTHAGOREAN TEMPERAMENT

```
4 Temperament
= Pythagorean
```

This temperament, which uses mathematical ratios to eliminate dissonance for fifths, is very limited for use with chords, but it produces very characteristic melodic lines.

4 Temperament  
= Meantone

### MEANTONE TEMPERAMENT

This temperament, which uses a mean between a major and minor whole tone to eliminate dissonance for thirds, was devised to eliminate the lack of consonance's experienced with certain fifths for the Mersenne pure temperament. It produces chords that are more beautiful than those with the equal temperament.

4 Temperament  
= Werckmeister

### WERCKMEISTER III TEMPERAMENT

### KIRNBERGER III TEMPERAMENT

These two temperaments are placed in between Meantone and Pythagorean. For music with few accidentals, this temperament produces the beautiful chords of the mean tone, but as accidentals increase, the temperament produces the characteristic melodies of the Pythagorean temperament. It is used primarily for classical music written in the Baroque era to revive the original characteristics.

4 Temperament  
= Kirnberger

4 Temperament  
= Equal(flat)

### EQUAL TEMPERAMENT (FLAT)

This is "unstretched" equal temperament that divides the scale into twelve equal semitones. This produces the same chordal intervals in all twelve keys, and has the advantage of limitless modulation of the key. However the tonality of each key becomes less characteristic and no chord is in pure consonance.

4 Temperament  
= Equal

### EQUAL TEMPERAMENT

This is the most popular piano temperament. The hearing ability of a human is uneven and is not as accurate with high frequency and low frequency as it is with the middle range. This temperament's tuning is stretched to compensate for this so the sound will be heard naturally to the ears. This "Stretched" equal temperament is a practical variation of the "unstretched" equal temperament which was invented on a mathematical basis.

4 Temperament  
= User

### USER TEMPERAMENT

You can make your own temperament by raising or lowering the pitch for each half tone.

Select the User temperament by using the VALUE buttons. Then use the MENU buttons to show the pitch data for each half tone.

4 Temperament  
C = 0

The display shows the current pitch for C key.

Use the VALUE buttons to change the pitch by cent.

**Continue the same procedure to set the pitch for all keys.**

◆ **NOTE**

The user temperament data is saved automatically even after the power is turned off. However, You must re select the user temperament each time you turn the power on unless you save it as your default temperament by using the User Memory function. Please see page 48 in this section for more information on User Memory.

◆ **NOTE**

After you have selected the desired temperament, please read the following section on selecting a key signature for the temperament before continuing.

## **5. KEY OF TEMPERAMENT**

Limitless modulation of the key became available only after the invention of Equal temperament. When we use a temperament other than Equal temperament, we must carefully choose the key signature to play in. For example, if the song you are going to play is written in D major, choose “D” as the temperament key.

**After selecting the “Key Signature” function by pressing the MENU buttons, use the VALUE buttons to set the desired key.**

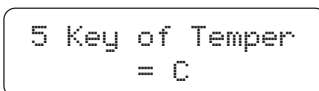

*The LCD display shows the currently selected key signature .*

Please note that changing the key of the temperament will only change the “balance” of the tuning, the pitch of the keyboard remains unchanged. Use the TUNING or TRANSPOSE functions to change the pitch of the whole keyboard.

## 13. POWER SWITCH

---

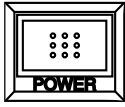

### TURNING THE POWER ON

**Press this button to turn on the power.  
Pressing it again will turn off the power.**

Pressing this button while holding down the REC and PLAY/STOP buttons will erase all the songs currently stored in memory.

## 14. VOLUME SLIDER

---

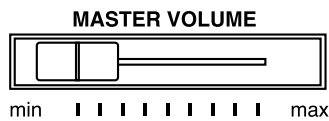

### CONTROLLING OVERALL VOLUME

This slider controls the master volume level of the piano's sound.

**Move this slider to the right to increase the volume and move to the left to decrease the volume.**

This slider also controls the headphone's volume and the LINE output level of the piano's sound.



# 15. PEDALS

---

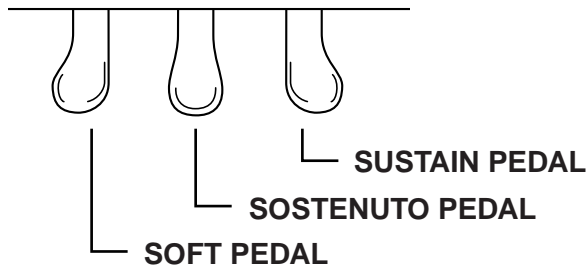

## SUSTAIN PEDAL

Depressing this pedal sustains the sound even after removing your hands from the keyboard. The sustain pedal is capable of responding to half pedaling, which provides even finer control of the dampening effect.

## SOSTENUTO PEDAL

Depressing this pedal after pressing the keyboard and before releasing the keys, sustains the sound of only the keys just played.

## SOFT PEDAL

Depressing this pedal softens the sound and also reduces its volume. When the Rotary Speaker effect is turned on, this pedal works as a switch to change effect speed.

# 16. JACKS

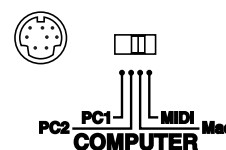
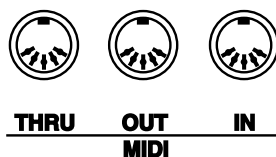
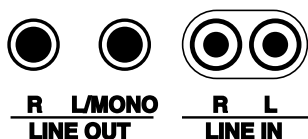

## LINE OUT JACKS

These jacks provide stereo output of the piano's sound to amplifiers, tape recorders or similar equipment.

The audio signal coming through the LINE IN jacks is also routed to these jacks. The piano's sound is mixed with the LINE IN signals.

The CA piano's VOLUME slider can control the output level of its own sound while it does not control the LINE IN signal.

## LINE IN JACKS

These jacks are used to connect a pair of stereo outputs from other audio equipment or electronic instruments to the piano's speakers.

The audio signal coming through these jacks bypasses the piano's volume control. To adjust the volume level, use the output control of the external device.

## MIDI JACKS

These jacks are used to connect external MIDI devices with the CA piano. There are three terminals: MIDI IN, MIDI OUT, and MIDI THRU.

## SERIAL INTERFACE

This jack is used to connect with a personal computer and exchange MIDI data. Select the proper setting for your computer using the selector. PC1: NEC Computers, PC2: IBM PC & compatibles, Mac: Apple Computers, MIDI: Serial Interface disabled. Select this setting when using the MIDI jacks. You need the serial MIDI driver when connecting with a Windows computer. It is available at <http://www.kawai.co.jp/english/download2.html> on the internet web.

## HEADPHONE JACKS

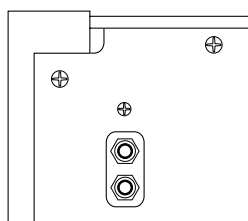

BOTTOM VIEW

There are two jacks for headphones provided at the left end on the bottom of the piano.

You can hear the piano's sound as well as any audio signal that is coming through the LINE IN.

# 17. MIDI INFORMATION

## PROGRAM CHANGE NUMBER MAPPING

Sound Name	When Multi-Timbral mode is ON		When Multi-Timbral mode is OFF	
	Program #	Bank # (MSB)	Prg # (CA1200)	Prg # (CA1000)
Concert Grand	1	0	1	1
Studio Grand	1	8	2	2
Mellow Grand	1	16	3	3
Jazz Grand *	1	93	4	-
Modern Piano	2	0	5	4
Rock Piano	2	8	6	5
New Age Piano	2	90	7	6
Honky Tonk *	4	0	8	-
Classic E.Piano	5	0	9	7
Modern E.P. 1	6	0	10	8
Modern E.P. 2	6	8	11	9
Modern E.P. 3 *	6	16	12	-
Jazz Organ	18	0	13	10
Drawbar Organ 1	17	0	14	11
Drawbar Organ 2	17	8	15	12
Be 3 *	17	91	16	-
Church Organ	20	0	17	13
Diapason	20	96	18	14
Full Ensemble	21	91	19	15
Diapason Oct *	20	95	20	-
Harpsichord	7	0	21	16
Harpsichord Oct	7	8	22	17
Harpsichord 2 *	7	90	23	-
Clavi	8	0	24	18
Vibraphone	12	0	25	19
Mellow Vibes	12	91	26	20
Marimba	13	0	27	21
Celesta *	9	0	28	-
String Ensemble	49	0	29	22
Slow Strings	45	90	30	23
String Pad	49	94	31	24
Warm Strings *	49	91	32	-
Choir	53	0	33	25
New Age Pad	89	0	34	26
Atmosphere	100	0	35	27
Itopia *	92	90	36	-
Wood Bass	33	0	37	28
Electric Bass	34	0	38	29
W. Bass & Ride	33	90	39	30
E. Bass & Ride *	34	92	40	-

\* CA1200 Only

# MIDI EXCLUSIVE DATA FORMAT



- 1 F0 . . . . . Start code
- 2 40 . . . . . Kawai's ID number
- 3 00 - 0F . . . . . MIDI channel
- 4 10,30 . . . . . Function code (30 when setting MULTI TIMBRE ON/OFF)
- 5 04 . . . . . Indicates that the instrument is Electronic Piano
- 6 02 . . . . . Indicates that the piano is one of "CA" series
- 7 data 1
- 8 data 2 . . . . . ( See the table below.)
- 9 data 3
- 10 F7 . . . . . End code

data 1	data 2	data 3	Function
00	00	—	MultiTimbre Off
02	00	—	Multi Timbre On
0D	00-06	—	00: Effect Off, 01: Chorus, 02: Delay1, 03: Delay2, 04: Delay3, 05: Tremolo, 06: Rotary 1, 07: Rotary 2
0E	00-05	—	00: Reverb Off, 01: Room, 02: Stage, 03: Hall, 04: 3D Room, 05: 3D Hall
14	00-7F	—	Dual/Split balance
16	1F-60	—	Tune, 40: 440 Hz
17	00, 7F	—	00: Program Change Off, 7F: Program Change On
18	00-07	—	00: Light, 01: Normal, 02: Heavy, 03: Off, 04: Light +, 05: Heavy +, 06: User 1 07: User 2
19	00-03	—	Lower Octave Shift
20	00-27(1D)	00-27(1D)	Dual, data 2: Right sound, data 3: Left sound
21	00-27(1D)	00-27(1D)	Split, data 2: Upper sound, data 3: Lower sound, ( ) for CA1000
25	00-08	00-0B	data 2: Temperament, data 3: Key
26	00, 7F	00-0F	Multi Timbre, data 2: 00 (On), 7F (Off), data 3: channel



# MIDI IMPLEMENTATION CHART

KAWAI DIGITAL PIANO MODEL: CA1200, CA1000

DATE: DECEMBER 2001  
VERSION 1.0

Function		Transmit	Receive	Remarks
<b>Basic</b>	Default	1	1	
<b>Channel</b>	Changes	1 – 16	1 – 16	
<b>Mode</b>	Default Messages Altered	3 X *****	3 1, 3*	* The default for the OMNI mode is ON. Specifying MIDI channels automatically turns it OFF.
<b>Note</b>		15 – 113**	0–127	
<b>Number</b>	True voice	*****	15 – 113	
<b>Velocity</b>	Note ON Note OFF	○ 9nH v=1–127 X 9nH v=0	○ X	
<b>After</b>	Key's	X	X	
<b>Touch</b>	Ch's	X	X	
<b>Pitch Bend</b>		X	X	
<b>Control</b>	0, 32 7 11 64 66 67	○ X X ○ (Right pedal) ○ (Center pedal) ○ (Left pedal)	○ ○ ○ ○ X ○	Bank Select Volume Expression pedal Sustain pedal Sustenuto pedal Soft pedal
<b>Program</b>		○ 0 – 127	○***	*** See the Program Change Number Mapping in page 75.
<b>Change</b>	:True #	*****		
<b>System Exclusive</b>		○	○	On/Off Selectable
<b>Common</b>	: Song Position : Song Select : Tune	X X X	X X X	
<b>System</b>	: Clock	X	X	
<b>Real Time</b>	: Commands	X	X	
<b>Aux</b>	: Local On/Off : All Notes Off : Active Sense : Reset	X X ○ X	○ ○ (123-127) ○ X	
<b>Notes</b>		** The value depends on the Transpose setting.		

Mode 1: OMNI ON, POLY  
Mode 3: OMNI OFF, POLY

Mode 2: OMNI ON, MONO  
Mode 4: OMNI OFF, MONO

○: Yes  
X: No



# CONCERT MAGIC SONG LIST

## BANK A

Title	Note#	Type
-------	-------	------

## CHILDREN'S SONGS

Bingo	G#1	EB
Frère Jacques	F#1	MP
Good Morning To You	F1	MP
Hickory Dickory Dock	D#1	EB
I'm A Little Teapot	A#0	MP
Itsy, Bitsy Spider	A1	MP
London Bridges	C#1	MP
Mary Had A Little Lamb	C1	MP
Pop Goes The Weasel	E1	MP
Row, Row, Row Your Boat	D1	MP
The Farmer In The Dell	G1	MP
This Old Man	B0	MP
Twinkle, Twinkle, Little Star	A0	MP

## CHRISTMAS SONGS

Deck The Halls	C2	MP
Hark The Herald Angels Sing	A#1	MP
Jingle Bells	B1	MP
Joy To The World	D2	MP
O Come All Ye Faithful	C#2	MP
Silent Night	E2	MP
The First Noel	D#2	MP
We Wish You A Merry Christmas	F2	MP
What Child Is This? (Greensleeves)	F#2	MP

## PATORIOTIC SONGS

America The Beautiful	A2	MP
Battle Hymn Of The Republic	G#2	MP
Hail To The Chief	B2	MP
My Country 'Tis Of Thee	G2	MP
Yankee Doodle	A#2	MP

## AMERICAN CLASSICS

Auld Lang Syne	C#4	MP
Beautiful Dreamer	A#4	EB
Bicycle Built For Two	F4	EB
Bill Bailey Won't You Please Come Home	G3	EB
Camptown Races	F#4	MP
Clementine	A3	MP
Danny Boy	C3	EB
Down In The Valley	C#3	EB
Fascination	A#3	SK
For He's A Jolly Good Fellow	F#3	EB
Give My Regards To Broadway	G#3	SK
Home On The Range	B3	MP
Home Sweet Home	D#3	EB
In The Good Old Summertime	F3	EB
Let Me Call You Sweetheart	D3	EB
Michael Row The Boat Ashore	D4	MP

My Bonnie Lies Over The Ocean	E3	EB
Oh Susanna	D#4	SK
On Top Of Old Smokey	E4	EB
Take Me Out To The Ballgame	C4	EB
The Band Played On	G4	EB
When Johnny Comes Marching Home	G#4	MP
When The Saints Go Marching In	A4	EB

## FAVORITE HYMNS

A Mighty Fortress	D6	MP
Amazing Grace	C5	MP
Doxology	C#5	MP
Fairest Lord Jesus	B4	MP
For The Beauty Of The Earth	D5	MP
Great Is Thy Faithfulness	C#6	MP
Holy, Holy, Holy	F5	MP
How Great Thou Art	C6	MP
Jesus Loves The Little Children	B5	MP
Just As I Am	A#5	MP
O Worship The King	D#5	MP
Rock Of Ages	G5	MP
Sweet Hour Of Prayer	A5	MP
The Old Rugged Cross	E5	MP
Trust And Obey	G#5	MP
What A Friend We Have In Jesus	F#5	MP

## CLASSICAL SELECTIONS

An Die Freude (Ode To Joy)	F6	MP
Andante (Haydn)	D#6	MP
Blue Danube Waltz	B6	SK
Clair De Lune	F#6	SK
Fledermaus	E7	EB
Für Elise	E6	EB
Gavotte (Gossec)	C#7	SK
Menuet In G (Bach)	A6	SK
Peter And The Wolf	G#6	SK
Romeo And Juliet	A#6	SK
Skater's Waltz	G6	SK
Sleeping Beauty Waltz	C7	EB
Toreador Song ("Carmen")	D#7	SK
Waltz Of The Flowers	D7	SK

## SPECIAL OCCASIONS

Bridal Chorus	F7	MP
Wedding March	F#7	SK

## INTERNATIONAL SONGS

Chiapenacas	C8	SK
Hatikvah	G#7	MP
Hava Nagilah	A#7	EB
Ich Bin Ein Musikant	B7	SK
My Wild Irish Rose	A7	EB
When Irish Eyes Are Smiling	G7	EB

**BANK B**

Title	Note#	Type
-------	-------	------

**CHILDREN'S SONGS**

Brahm's Lullaby	D#1	SK
Did You Ever See A Lassie?	C#1	MP
Here We Go Round The Mulberry Bush	F1	MP
Little Brown Jug	F#1	MP
Old Macdonald Had A Farm	C1	MP
Polly Wolly Doodle	A1	MP
Rock A Bye Baby	E1	EB
She'll Be Comin' Around The Mountain	G1	EB
Ten Little Indians	D1	MP
The Muffin Man	A#0	MP
Three Blind Mice	B0	MP
Where, O Where Has My Little Dog Gone?	A0	EB
Whistler And His Dog	G#1	SK

**CHRISTMAS SONGS**

Angels We Have Heard On High	A#1	MP
Ave Maria	F#2	SK
Away In A Manger	C2	MP
It Came Upon A Midnight Clear	B1	MP
O Holy Night	C#2	EB
O Little Town Of Bethlehem	F2	MP
O Tannenbaum	D2	MP
The Twelve Days Of Christmas	D#2	MP
We Three Kings Of Orient Are	E2	MP

**PATORIOTIC SONGS**

Anchors Aweigh	A#2	SK
Stars And Stripes Forever	A2	SK
Under The Double Eagle	B2	SK
Washington Post March	G2	SK
You're A Grand Old Flag	G#2	EB

**AMERICAN CLASSICS**

After The Ball Is Over	E4	EB
After You've Gone	F4	EB
American Patrol March	F#3	MP
Annie Laurie	G4	MP
Arkansas Traveler	A#3	MP
Blue Bells Of Scotland	D3	MP
By The Light Of The Silvery Moon	E3	SK
Dixie	G3	SK
Down By The Riverside	D#3	SK
Grandfather's Clock	A#4	EB
I Love Coffee, I Love Tea	A3	MP
I've Been Working On The Railroad	A4	EB
Maple Leaf Rag	D#4	SK
Old Folks At Home	D4	SK
Old Kentucky Home	B3	SK
Red River Valley	C4	EB

Shine On Harvest Moon	F3	SK
Ta Ra Ra Boom De Ay	C3	EB
The Entertainer	C#4	SK
Thunder And Blazes	F#4	SK
Turkey In The Straw	C#3	SK
Wabash Cannonball	G#4	SK
Yellow Rose Of Texas	G#3	SK

**FAVORITE HYMNS**

All Hail The Power Of Jesus Name	C#6	MP
Blest Be The Tie That Binds	D5	MP
Christ The Lord Is Risen Today	B4	MP
Come Thou Almighty King	D#5	MP
Crown Him With Many Crowns	C#5	MP
Gloria Patri	F#5	MP
I Need Thee Every Hour	A5	MP
It Is Well With My Soul (When Peace Like)	C5	MP
My Jesus, I Love Thee	E5	MP
Onward Christian Soldiers	C6	MP
Savior Like A Shepherd Lead Us	A#5	MP
Stand Up, Stand Up For Jesus	B5	MP
Standing On The Promises	G#5	MP
The Church's One Foundation	F5	MP
The Solid Rock	G5	MP
To God Be The Glory	D6	MP

**CLASSICAL SELECTIONS**

Allegro Moderato (Schubert)	E7	SK
Can Can	F6	SK
Emperor Waltz	F#6	SK
Grand March ("Aida")	G#6	SK
Gymnopedie	A6	SK
Gypsy Chorus	A#6	SK
Largo (Dvorák)	B6	SK
March Militaire	G6	SK
Norwegian Dance	D#6	SK
Pizzicato Polka	C#7	SK
Prelude In A (Chopin)	C7	MP
Rondeau (Mouret)	D7	SK
Voice Of Spring	D#7	EB
William Tell Overture	E6	SK

**SPECIAL OCCASIONS**

Mazel Tov	F#7	EB
Pomp And Circumstance	F7	SK

**INTERNATIONAL SONGS**

Funiculi Funicula	G7	SK
Habanera	B7	SK
La Bamba	C8	SK
La Marseillaise	G#7	MP
La Paloma	A7	SK
Santa Lucia	A#7	SK

# Front Panel

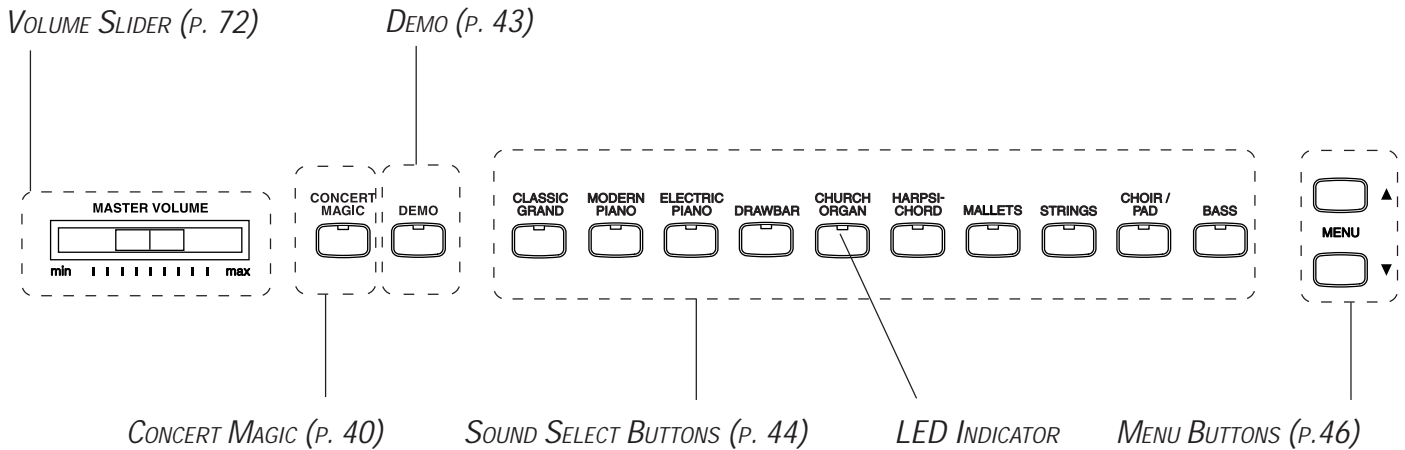

# Demo Songs

Classic Grand	Concert Grand	Hungarian Dance No.1 / Brahms (Etude, op.10-5 / Chopin)
	Studio Grand	Original
	Mellow Grand	La Fille aux Cheveux de Lin / Debussy
Modern Piano	Modern Piano	Original
	Rock Piano	Original
Electric Piano	Classic E.Piano	Original
	Modern E.P. 1	Original
	Modern E.P. 2	Original
Drawbars	Jazz Organ	Original
	Drawbar Organ 1	Original
	Drawbar Organ 2	Original
Church Organ	Church Organ	Tocatta / Eugene Gigout
	Diapason	Wohl mir, daß ich Jesum habe / Bach
	Full Ensemble	Original
Harpsichord	Harpsichord	French Suite No. 6 / Bach
	Harpsichord Oct.	Prelude in A <sup>b</sup> / Bach
	Clavi	Original
Mallets	Vibraphone	Original
Strings	String Ensemble	Le quattro stagioni La primavera / Vivaldi
	Slow Strings	Original
	String Pad	Original
Choir/Pad	Choir	Original
	Atmosphere	Original
	New Age Pad	Original
Bass	Wood Bass	Original
	Electric Bass	Original
	W. Bass & Ride	Original

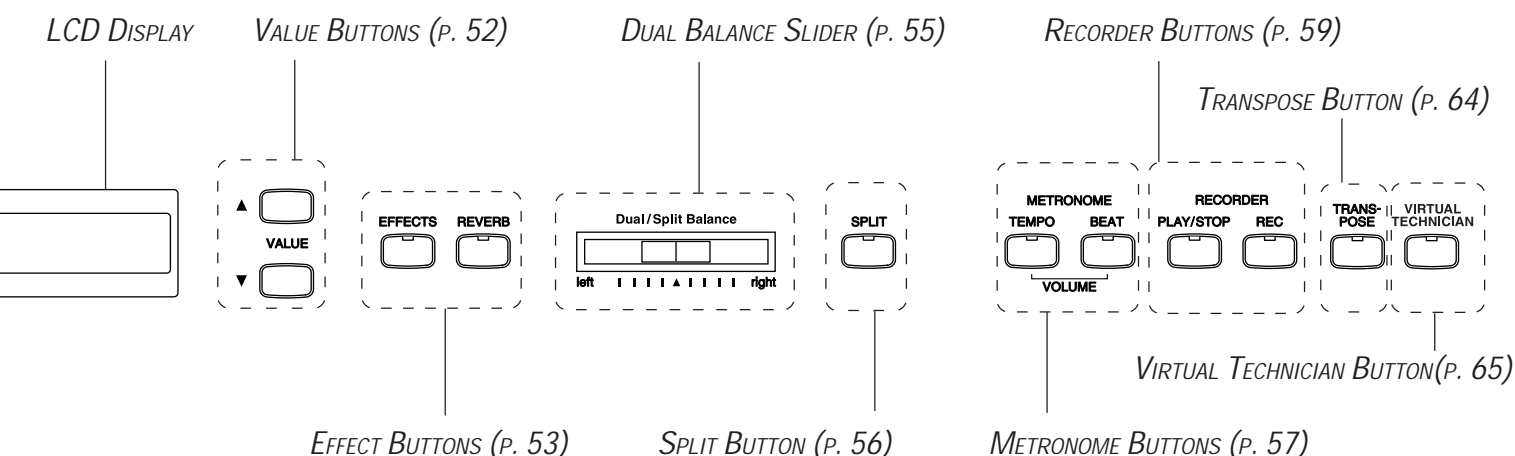

## Specifications

	CA1200	CA1000
Keyboard	88 Wooden Keyboard	
Polyphony	Maximum 64	
Preset Tones	Classic Grand (4), Modern Piano (4), Electric Piano (4), Drawbar (4), Church Organ (4), Harpsichord (4), Mallets (4), Strings (4), Choir/Pad (4), Bass (4)	Classic Grand (3), Modern Piano (3), Electric Piano (3), Drawbar (3), Church Organ (3), Harpsichord (3), Mallets (3), Strings (3), Choir/Pad (3), Bass (3)
Effects	Reverb (3), 3-D Reverb (2), Chorus, Tremolo, Delay (3), Rotary (2)	
Temperaments	Equal (Piano Only), Mersenne pure (Major), Mersenne pure (minor), Pythagorea, Meantone, Werckmeister III, Kirnberger III, Equal (flat), Equal, User	
Other Features	Concert Magic (176 Preset Songs), Volume, Dual, Split, Dual/Split Balance, Transpose, Tune, Sympathetic Resonance, Virtual Voicing, Touch Curve (Light, Light+, Normal, Heavy, Heavy+, Off, User 1/2), MIDI (16 part multi-timbral capability)	
Recorder	2 Tracks, 5 Songs The total memory capacity of the recorder is approximately 8000 notes.	
Pedals	Sustain with Half Pedal function, Sostenuto, Soft	
Jacks	Headphone (2), LINE IN (L, R), LINE OUT (L/MONO, R), MIDI (IN, OUT, THRU), PC I/F	
Output Power	45W x 2	
Speakers	13 cm x 2 (with wooden enclosure) 2.5 cm x 2 (dome tweeter)	13 cm x 2 (with enclosure) 5 cm x 2 (tweeter)
Power Consumption	80W	
Finish	Rosewood, Mahogany, European Cherry	
Dimensions (W x D x H)	142 x 52 x 95 cm, 56" x 21" x 38"	138 x 51 x 94 cm, 55" x 20" x 37"
Weight (without bench)	84.5 kg, 186 LB's	68.0 kg, 150 LB's

# **KAWAI**

CA1200, CA1000 Owner's Manual  
OW959E-L0112  
Printed in Japan

英文